

出國報告（出國類別：出席國際會議）

赴印尼參加  
第 61 屆國際灌溉排水協會國際執行委員會議  
暨第 6 屆亞洲區域研討會報告

服務機關：國際灌溉排水協會中華民國國家委員會等

派赴國家：印尼

出國期間：中華民國 99 年 10 月 10 日至 10 月 17 日

報告日期：中華民國 99 年 12 月 31 日



## 摘要

國際灌溉排水協會第 61 屆國際執行委員會議暨第 6 屆亞洲區域研討會議活動，於 10 月 10 日起至 10 月 17 日計 8 天在印尼日惹縣舉行，由莊主席光明率團參與會議及技術參訪，成員包括中興工程顧問社陳執行長伸賢、中水局江副局長明郎、農委會林技正國華、成功、中央、義守、清雲、立德、淡江等大學教授、農田水利會及中興工程顧問公司駐印尼代表人員等一行 27 員參加，本次由國際灌溉排水協會印尼國家委員會主辦之研討會議主題為「改善小農地區之灌溉與排水效率」，台灣代表參與論文發表共 5 篇，另分別參與 10 場技術委員會工作小組會議。本次研討會中各國代表共發表了 85 篇技術論文，涵蓋農地轉作、參與式灌溉管理及灌溉水之多功能角色等議題等廣泛範圍。

大會並於閉幕式中發表「日惹宣言」，其呼籲政府機關、知識機構、農業服務機構、國際組織及金融機構等單位，從各國汲取經驗並發展最佳實行方法，有效地整合小農用水者成為夥伴關係，對於因應都市化、工業化、土地變更及氣候變遷等課題，共同進行開發及管理事宜，並創造永續農業及非農業的工作機會，改善城鄉生活差距。該宣言所提出之議題，可供我國推動農田水利方向之參考。

此次國際會議在印尼召開，印尼估計每年從分布在各群島的 5,888 條河川中之可取水量約為 25,300 億噸，其中目前每年可用水量約為 1,570 億噸，農業用水約占 80%，民生及工業用水占 20%。根據統計，印尼約有 1,100 萬公頃土地具有發展為灌溉農業可耕地之潛力，但實際上只有 750 萬公頃為已開發的灌區。印尼於西元 1969~1994

年間進行加強灌溉系統整復及發展工作，其中分別進行了面積規模 260 萬公頃、170 萬公頃及 200 萬公頃等 3 次新開發地及農田之整復及發展工作。根據印尼 2002 年統計資料顯示，其水田灌溉總面積約為 780 萬公頃，作物密度為 1.35%，除了主要作物稻米總產量達 4,880 萬噸外，同年次級作物包括玉蜀黍、大豆及花生的產量分別為 950 萬噸、95.3 萬噸及 72.2 萬噸。本次技術考察，對印尼之灌溉技術及經驗，有進一步之瞭解，在本報告中特別介紹該國之水資源及灌溉事業發展概況供參考。

# 目 錄

摘 要.....	I
目 錄.....	III
壹、目的.....	1
貳、過程.....	2
一、考察團員.....	2
二、會議行程表.....	3
三、參加會議議程.....	4
四、技術考察.....	6
參、心得.....	7
一、參加會議.....	7
(一) 第 61 屆國際執行委員會會議.....	7
(二) 技術活動委員會工作小組會議.....	10
(三) 第 6 屆亞洲區域研討會-台灣論文發表.....	14
(四) 日惹宣言.....	15
二、技術考察.....	17
(一) 印尼簡介.....	17
(二) 印尼灌溉事業發展概況.....	18
(三) 印尼日惹-莫拉比火山技術考察.....	18
(四) 印尼日惹-稻米耕種計畫技術考察.....	24
三、參加會議及技術考察心得.....	28
肆、建議事項.....	30

附錄一 提升砂土保水能力之試驗

Experiments on the Increase of Water-Holding Capacity in Sandy Soils

(台灣論文發表- 鄭昌奇、詹明勇、黃小珍、甘俊二)

附錄二 台灣農業回歸水再利用之調查、評估及操作管理之研析

Investigation, Assessment and Operation Management of the Reuse of Agriculture Return Water in Taiwan

(台灣論文發表- 劉建邦、蔡文豪、謝國正、陶方策)

附錄三 台灣地區灌溉事業因應氣候變遷調適策略研析

Study on Climate Change Adaptation Strategies for Irrigation Affairs in Taiwan

(台灣論文發表- 蔡明華、林尉濤、虞國興)

附錄四 利用 Vensim 模式估算區域性水稻灌溉系統之供水量

The Estimation of Water Supply of Regional Paddy Irrigation System by Vensim Model

(台灣論文發表- 黃浩烈、吳瑞賢)

附錄五 曹公圳多功能利用與發展策略之研究

Multifunctional Uses and Development Strategies of Tsao-Gung Canal

(台灣論文發表- 葉世旭)

附錄六 會議影像集錦

## 壹、目的

國際灌溉排水協會(International Commission on Irrigation and Drainage, ICID)成立於 1950 年 6 月 24 日，迄今計有 108 個會員國。ICID 為一科學、技術和非營利為目的之非政府國際組織(NGO)，致力於灌溉排水、防洪及環境管理等技術研討以提高世界糧食之需求；其主旨以工程、農糧、經濟、生態及社會等不同專業領域應用於水土資源管理，以達到永續灌溉農業環境的維護。目前 ICID 於水管理技術和處理相關問題已累積 50 年以上豐富經驗。ICID 每一年定期舉行國際執行委員會議及學術研討會議。

我國於 1969 年由農復會申請加入國際灌溉排水協會，至 1995 年由有關機關及團體組成國家委員會，並自 1996 年起以國際灌溉排水中華民國國家委員會(Chinese Taipei Committee-CTCID)之身分積極加入國際灌溉排水協會相關委員會與工作小組之委員，每年參與年度大會及各項研討會議。為展現我國在灌溉排水領域之優勢實力及水利科技實務之成果，我國代表團積極投入參與大會國際執行會議及技術委員會之工作小組會議，期與各國代表相互交流經驗與研究成果，俾推展國際事務連繫及技術交流，以擴展我國在國際組織之活動空間，同時，增加我國對於世界各國在水資源管理、農業發展、環境與生態保護等方面發展之瞭解。

本次組團出國之目的，為參加第 61 屆國際灌排協會執行委員會之技術委員會工作小組會議暨第 6 屆亞洲區域研討會，除由專家學者做論文發表外，亦另外安排技術考察印尼之農田水利及灌溉農業情形。

## 貳、過程

## 一、考察團員

序號	姓名	職稱	機關名稱
1	莊光明	主席	國際灌排協會中華民國國家委員會
2	陳仲賢	執行長	財團法人中興工程顧問社
3	江明郎	副局長	經濟部水利署中區水資源局
4	林國華	技正	行政院農業委員會農田水利處
5	周師文	總幹事	台北市七星農田水利會
6	林元麒	辦事員	台北市瑠公農田水利會
7	張金珠	總務組長	台灣省石門農田水利會
8	黃朝統	工程師	台灣省桃園農田水利會
9	王斌祥	主任工程師	台灣省新竹農田水利會
10	李坤穎	三等助理工程師	台灣省苗栗農田水利會
11	張連對	管理股長	台灣省雲林農田水利會
12	廖文藝	副工程師	台灣省南投農田水利會
13	陳志忠	副管理師	台灣省嘉南農田水利會
14	蘇俊霖	工程師	台灣省高雄農田水利會
15	廖榮熙	管理組長	台灣省台東農田水利會
16	吳瑞賢	教授	國立中央大學土木工程系
17	高瑞棋	副所長	國立成功大學水工試驗所
18	王筱雯	助理教授	國立成功大學水利及海洋工程學系
19	劉珺貽	行政助理	國立成功大學水工試驗所
20	郭勝豐	教授	立德大學休閒資源暨綠色產業學系
21	鄭昌奇	副教授	清雲科技大學工業工程與管理系
22	詹明勇	副教授	義守大學土木與生態工程學系
23	陳育成	主任	中興工程顧問公司(印尼代表處)
24	李聰輝	顧問	中興工程顧問公司(印尼代表處)
25	陶方策	工程師	中興工程顧問公司
26	舒文斌	副組長	淡大水資源管理與政策研究中心
27	倪佩君	秘書	國際灌排協會中華民國國家委員會



## 二、會議行程表

(一) 出國時間自 99 年 10 月 10 日至 10 月 17 日。

(二) 會議時間自 99 年 10 月 11 日至 10 月 16 日，行程如下：

日期（星期）	行程內容
10 月 11 日 （一）	<ul style="list-style-type: none"> <li>● 工作小組會議： 「ASRWG」、「WG-HIST」 「WG-ENV」、「WG-DRG」 「WG-DROUGHT」</li> <li>● ICID 主席與各國家委員會代表會議</li> </ul>
10 月 12 日 （二）	<ul style="list-style-type: none"> <li>● 工作小組會議： 「WG-CLIMATE」、「WG-MIS」</li> </ul>
10 月 13 日 （三）	<ul style="list-style-type: none"> <li>● 工作小組會議： 「WG-SDTA」、「WG-WATS」 「WG-ON-FARM」</li> <li>● 大會考察行程：【Merapi Sabo Dam】</li> <li>● 歡迎晚會</li> </ul>
10 月 14 日 （四）	<ul style="list-style-type: none"> <li>● 第 6 屆亞洲區域研討會（大會開幕式）</li> <li>● 伊朗晚宴</li> </ul>
10 月 15 日 （五）	<ul style="list-style-type: none"> <li>● 第 60 屆國際執行委員會會議</li> <li>● 第 6 屆亞洲區域研討會</li> <li>● 大會考察行程：【Project SRI】</li> <li>● 歡送晚宴</li> </ul>
10 月 16 日 （六）	<ul style="list-style-type: none"> <li>● 第 6 屆亞洲區域研討會（大會閉幕式）</li> </ul>

## 三、參加會議議程

日期 (星期)	時間	大會議程	參加人員
10/11 (一)	09:00-12:30	<b>【ASRWG】</b> 「亞洲區域」	郭勝豐、莊光明 陳仲賢、高瑞棋
		<b>【WG-ENV】</b> 「環境」	吳瑞賢、江明郎、陶方策
		<b>【WG-HIST】</b> 「灌溉、排水及防洪史」	舒文斌、虞國興
		<b>【WG-DRG】</b> 「排水」工作小組會議	鄭昌奇、詹明勇
	13:30-18:00	<b>【WG-DROUGHT】</b> 「水源緊張區域之水管理」	鄭昌奇、江明郎、林國華 蘇俊霖、陳志忠、陶方策
10/12 (二)	09:00-12:30	<b>【WG-CLIMATE】 &amp; WS</b> 「全球變遷與灌溉」	吳瑞賢、江明郎、林國華 周師文、王斌祥、張金珠 林元麒、陶方策
	13:30-18:00	<b>【WG-MIS】</b> 「現代化灌溉服務」	李聰輝、周師文、張金珠 張連對、黃朝統、蘇俊霖 李坤穎、廖文藝、陳志忠
10/13 (三)	09:00-12:30	<b>【WG-WATS】 &amp; WS</b> 「農業節水」	郭勝豐、林國華
		<b>【WG-ON-FARM】</b> 「田間灌溉系統」	舒文斌、詹明勇
	13:30-18:00	<b>【WS-SDTA】</b> 「感潮區永續發展」	高瑞棋、王筱雯、劉珺貽
	19:00-21:00	歡迎晚會 (Keraton-the Sultans Palace of Yogyakarta)	全員出席

日期 (星期)	時間	大會議程	參加人員
10/14 (四)	09:00-12:30	第 6 屆亞洲區域研討會 (開幕典禮)	全員出席
	13:30-18:00	第 6 屆亞洲區域研討會	自選參加
	19:00-21:00	伊朗晚宴	全員出席
10/15 (五)	09:00-12:30	第 60 屆國際執行委員會議 (第一場)	莊光明主席 虞國興秘書長 吳瑞賢副秘書長
		第 6 屆亞洲區域研討會	自選參加
	13:30-18:00	第 60 屆國際執行委員會議 (第二場)	莊光明主席 虞國興秘書長 吳瑞賢副秘書長
		第 6 屆亞洲區域研討會	自選參加
	19:00-21:00	歡送晚會 (Prambanan Temple, 17 km East of Yogyakarta)	全員出席
10/16 (六)	09:00-12:30	第 6 屆亞洲區域研討會	自選參加
	13:30-18:00	第 6 屆亞洲區域研討會 (閉幕典禮)	全員出席

#### 四、技術考察

本次參加印尼大會安排之部分考察行程如下：

類別	日期 (星期)	參訪地點
TEC-01 技術參訪	10/13 (三) 1日	<b>【Merapi Sabo Dam】</b> <ul style="list-style-type: none"><li>• 莫拉比火山為全世界 129 座活火山之 1。其噴發週期為 3-7 年。</li><li>• Merapi Sabo Dam 位於莫拉比火山區，其主要功能為控制 Merapi 火山岩流，保護下游地區。</li></ul>
TEC-02 技術參訪	10/15 (五) 1日	<b>【Project SRI】</b> <ul style="list-style-type: none"><li>• SRI: System of Rice Culture Intensification，稻米耕種計畫區。</li><li>• 2005 年起實施耕種實驗計畫，共分為 4 個計畫區，每一區域分別給予不同的土壤環境，用以評估灌溉水量及作物產量。</li></ul>

## 參、心得

### 一、參加會議

#### (一)第 61 屆國際執行委員會會議

本次進行 15 項議程討論，CTCID 由莊光明主席代表出席參加本次會議，與會各國國家委員會主席表決各項議案，並投票改選總會 3 位副主席。茲將本次議程決議重點整理如下，以了解 ICID 之會務運作，並供我國代表未來參與 ICID 相關活動及會議之參考。

#### 1. 會議預告

- 2011 年
  - (1) 10 月 15-23 日-伊朗·德黑蘭
    - 第 62 屆國際執行委員會
    - 第 21 屆國際灌溉排水研討大會
- 2012 年
  - (2) 6 月 24-29 日-澳洲·阿得萊德
    - 第 63 屆國際執行委員會
    - 第 7 屆亞洲區域研討會
- 2013 年
  - (3) 土耳其
    - 第 64 屆國際執行委員會
    - 第 8 屆亞洲區域研討會
- 2014 年
  - (4) 韓國
    - 第 65 屆國際執行委員會
    - 第 22 屆國際灌溉排水研討大會

#### 2. 國際灌排協會積極會員

國際灌排協會網絡遍及 110 國，其中包括 28 個非洲國家委員會、18 個美洲國家委員會、35 個亞太地區國家委員會以及 29 個歐洲國家委員會。截

至 2010 年 8 月底為止，目前的積極會員數計 65 個國家。

### 3.國際灌排協會網站及文件提供服務

截至 2010 年 7 月 31 日為止，文件資料庫已彙編完成 8,708 篇文章，至於在書名部分，至今可檢索 31,596 本。從 2009 年 4 月 1 日至 2010 年 7 月 31 日年間，文件資料庫共新增 996 篇國際灌排協會與其他出版品的文章。2009 年間印製的免費出版品，已經寄發給全體會員國的國家委員會/國際灌排協會委員會、現任主管、管理委員會(MB)成員及其他人士。

- (1) 2010 年多語系灌溉排水辭典(MTD)－光碟版。
- (2) 2010 年 ICID60 週年－光碟版。
- (3) 2009 年巴基斯坦拉合爾第 20 屆灌排研討大會會議紀錄－光碟版。
- (4) 2009 年第五屆世界水論壇：Topic 2.3 – 消弭貧窮與飢餓之水與糧食－報告及光碟版。

### 4.節水 (WatSave) 獎

擔任評審團召集人的前主席 Peter S. Lee，於會中宣布得獎名單，獎項及得獎人員如下：

#### (1) 節水技術獎－

Irrigation water security: promoting on-farm reservoirs in the UK  
Dr. Keith Weatherhead, Mr. Melvyn Kay and Dr. Jerry Knox (UK)  
(英國)

#### (2) 節水創新水資源管理獎－

Water distribution management at Valhartswater  
Mr. Kobus Harbron (南非)

### 5.國際灌排協會期刊《灌溉與排水》之最佳論文獎

2010 年最佳論文獎選自 2009 年間投稿至本會期刊的文章，預定由國際灌排協會編輯委員會(EB-JOUR)主席暨本會前主席 Bart Schultz 宣布得獎者：  
Farmers' perceptions and engineering approach in the modernization of a community-managed irrigation scheme. A case study from an oasis of the Nefzawa (South of Tunisia)

W. Ghazouani, S. Marlet, Mekki and A. Vidal (Volume 58, S3)

## 6. 國際灌排協會與聯合國水組織之能力發展十年計畫(UNW-DPC)共同簽署 農業用水能力發展計畫備忘錄

國際灌排協會及聯合國水資源組織管理能力十年發展計畫(UNW-DPC)共同簽署一份從 2010 年 4 月起為期 2 年之農業用水能力發展計畫之合作備忘錄。

## 7. 三位副主席之改選

- 副主席選舉

根據國際灌排協會組織章程(1996 年)第 6.2.4 條的規定，下列三名副主席的三年任期(2007-2010)，將於印度舉行的國際執行委員會會議結束後任職期滿。

Dr. Peter Kovalenko	烏克蘭
Dr. Hafied A. Gany	印尼
Engr. Dr. Illahi B. Shaikh	巴基斯坦

新任 ICID 副主席：

- Dr. Ragab Ragab (英國)
- Engr. Husnain Ahmad (巴基斯坦)
- Mr. Chaiwat Prechawit (泰國)



(英國)



(巴基斯坦)



(泰國)

## (二)技術活動委員會工作小組會議

目前 ICID 技術委員會各類別工作小組中台灣 CTCID 所屬之正式委員計有 12 位，然各委員並無法全數出席本年度會議，故由代表團分派代表分別參加 10 場工作小組會議，茲將各工作小組會議內容重點摘要如下：

### 區域工作小組

#### 1.亞洲區域工作小組會議【ASRWG】

- (1)ICID 與國際水田與水環境工程學會(PAWEES)和國際水環境與水田網路(INWEPF)合作密切。INWEPF 針對糧食安全、消弭貧窮、永續用水及夥伴關係等議題已有所研析，建議各委員們應踴躍投稿 PAWEES 期刊且出席年會，以利經驗交流與訊息流通。
- (2)為持續拓展網路聯繫，ICID 要求全體國家委員會建立專屬網頁，與亞洲區域各國家委員會建立網路連結，並提供網站連結至總會辦公室。

### 知識類組

#### 2.灌溉、排水及防洪史工作小組會議【WG-HIST】

- (1)主任委員建議工作小組辦理有關“透過歷史探討永續”研討會，並將試著取得聯合國教科文組織的支持。此外，亦將聯繫德國水資源歷史協會(DwhG)，邀請一起籌辦此研討會議。
- (2)主任委員建議將收集之水資源歷史紀錄片以英語方式彙整，以便建立水資源歷史之紀錄片資料庫。台灣委員代表(舒文斌博士)於本次會中提交台灣灌溉史，並向小組簡介相關更新資訊，電子檔案已可在網站上下載。

### 流域類組

#### 3.乾旱工作小組會議【WG-DROUGHT】

- (1)工作小組仍持續進行“*Irrigation under Drought and Water Scarcity*”之出版事宜。
- (2)本期(2011~2013)工作計畫將探討「乾旱管理對策」、「面對水源稀少性」及「永續農業之降雨管理」等議題，由主任委員指定各議題負責人，台灣委員代表鄭昌奇教授將負責「*Drought Management Strategies*」之議題。



#### 4.全球變遷及農業水管理工作小組會議【WG-CLIMATE】

- (1)工作小組提議 2011 年於伊朗德黑蘭會議中舉辦「Climate Change Symposium」研習會議。
- (2)建議於 2012 年世界水資源週期間，辦理一日研習會議。
- (3)本工作小組原任期為 2005~2011 年，建議再延長 3 年任期。
- (4)各國委員代表提出簡報：
  - 美國—Mr. Maurice Roos：Can We Save the California Delta From the Effect of Sea Level Rise?
  - 日本—VP ICID Shinsuke OTA, ARTF-CC：Japan's Countermeasures for Global Warming and Activities of Asian Regional Task Force on Climate Change.
  - 南非—Prof. Sue Walker：Agricultural Interventions for Climate Variability
  - 台灣—吳瑞賢教授：Climate change adaptation strategies for irrigation affairs in Taiwan.

#### 5.感潮區永續發展工作小組會議【WG-SDTA】

- (1)感潮區永續發展工作小組所出版的手冊涵蓋感潮區特性與演變過程、感潮區規劃管理、感潮區永續發展相關工程與整合決策支援系統等相關議題與案例討論，此手冊宜廣泛推廣於台灣各相關學術、政府、研究等單位，且應努力發展台灣相關案例。
- (2)本工作小組就未來新一任期討論之工作方向，朝向因應全球氣候變遷、低地治理、海洋能源發展等方面努力，建議宜積極參與其他各相關工作小組技術合作與經驗交流；舉辦研討會活動以推動氣候變遷之下，海岸潮間帶等低地灌溉排水與禦潮設施設計標準；於海岸低地區域設立物理化學及生態環境監測系統，以進一步建立洪水及乾旱預警系統；進行海岸地下水調查評估與及對海洋能開發可行性進行了解；了解感潮區因全球氣候變遷環境受損的風險提高，以進一步尋求開發與保育之間的平衡。
- (3)建議就各國之全球氣候變遷趨勢與因應做法能有更多座談或工作坊之交流，透過分享及對話的方式，以吸取更多的經驗引以為鑒。
- (4)有關低地治理中的溼地研究，宜針對人工溼地與自然濕地等相關案例，進檢視現行各國做法、成敗經驗、設計標準，並根據地層下陷實際狀況

的限制因素，就水力效率與經濟效益等層面進行評估。

- (5)有關於 2011 年預計在 ICID 期刊刊載的 Sponsored issue 與在荷蘭舉辦的 European Regional Conference，建議宜及早規劃準備。

#### 6.灌溉排水與防洪對環境衝擊工作小組會議【WG-ENV】

- (1)訂定本小組 3 個新的工作方針，每一議題由 3~4 名委員共同負責，並選議題主持人負責統籌相關執行工作之進度。

- 灌溉與排水計畫之環境議題
- 灌溉與排水計畫對人類之影響
- 永續環境之管理(提升灌排系統之優點並降低其缺點)

- (2)本小組今年辦理研習會議，共發表 7 篇論文。

#### 7.排水工作小組會議【WG-DRG】

- (1)決議辦理國際排水研習會議之日期及地點如下：

- 2012 年於埃及開羅，舉辦第 11 屆國際排水研習會。
- 2013 年於俄羅斯聖彼得堡，舉辦第 12 屆國際排水研習會。

- (2)主任委員 Dr. Vlotman 介紹 LinkedIn Agricultural Drainage Group 專屬社群網站之使用方式，並鼓勵各委員加入此交流平台。

### 系統類組

#### 8.現代化灌溉服務工作小組會議【WG-MIS】

- (1)各國委員代表提出簡報：

- 馬來西亞—Mr. Mohd Yazid Abdullah：Mascotte 在現代化灌溉系統上的應用- 馬來西亞 Tanjung Karang 水稻灌溉計畫之個案分析，研究結果認為 Mascotte 是非常有用的快速評估方法。
- 日本—Dr. Masayoshi Satoh：日本的現代化灌溉系統，此報告內容涵蓋了日本灌溉系統的特殊功用，以及日本氣象協會管理下的 Toyogowa 灌溉計畫個案研究。這份研究指出現代化成功的必要條件，如所有利益相關者之意願，特別是用水人，必要讓他們以最小但有效益的資金參與。
- 台灣—舒文斌博士：台灣現代化灌溉策略及 Mascotte 在桃園灌溉系統上之應用，此研究提出了相當有幫助的結論，並在 Mascotte 的運用面給了一些改進上之建議，包括對某些指標其適當性之探討。

- 澳洲—Mr. Ian Moorhouse：澳洲的現代化灌溉事務，考量了 Goulburn Murray 灌區之現象，並與七項被認為是成功現代化之必要徵兆來做結論。

### 9.農業節水工作小組會議【WG-WATS】

- (1)會議通過節水獎(WatSave Awards)之獎金額度與交通補助費。工作小組建議應恢復農民獎(Farmer award)，此獎項金額為美金 2000 元，不含交通費。
- (2)各國家委員會在每一類別獎項中，僅能出 1 名候選人。

### 農田類組

### 10.田間灌溉系統工作小組會議【WG-ON-FARM】

- (1)2011 年 10 月 18-19 日將於伊朗德黑蘭會議期間舉辦「第 8 屆國際微灌研討大會」，會議主題-創新的微灌技術與管理，以提高作物產量
- (2)各國委員代表提出簡報：
  - 義大利—Mr. Graziano Ghinassi：喉轆雨槍灌溉之新技術應用：邁向永續滴灌之新遠景。
  - 加拿大—Mr. Tollefson：灌區作物之用水效率。
  - 南非—VPH Felix B. Reinders：穩定糧食生產之用水與灌溉。

## (三)第 6 屆亞洲區域研討會議-台灣論文發表

會議主題：「改善小農地區之灌溉與排水效率」

論文題目	共同作者	附件
<b>子議題 1：「在水資源日漸短缺及農地轉作與農地分割議題下之灌溉」</b>		
1.Experiments on the Increase of Water-Holding Capacity in Sandy Soils 提升砂土保水能力之試驗	鄭昌奇、詹明勇 黃小珍、甘俊二	附錄一
<b>子議題 2：「未來 10 年小農在灌溉農業上所面臨之挑戰」</b>		
2.Study on Investigation, Assessment and Operation Management of the Reuse of Agriculture Return Water in Taiwan 台灣農業回歸水再利用之調查、評估及操作管理之研析	劉建邦、蔡文豪 謝國正、陶方策	附錄二
3.Study on Climate Change Adaptation Strategies for Irrigation Affairs in Taiwan 台灣地區灌溉事業因應氣候變遷調適策略研析	蔡明華、林尉濤 虞國興	附錄三
<b>子議題 3：「利用參與式灌溉發展與管理方法為小農地區提升灌溉與排水效率」</b>		
4.The Estimation of Water Supply of Regional Paddy Irrigation System by Vensim model 利用 Vensim 模式估算區域性水稻灌溉系統之供水量	黃浩烈、吳瑞賢	附錄四
<b>子議題 5：「在農村及都市基礎建設快速發展下，協調大農與小農灌溉」</b>		
5.Multifunctional Uses Canal & Development Policies On Tsao-kung Irrigation System 曹公圳多功能利用與發展策略之研究	葉世旭	附錄五

#### (四)日惹宣言

2010年10月14日至16日於印尼·日惹召開第6屆亞洲區域研討會議期間的所有與會者，我們共同：



#### 探討議題

- 發展參與式灌溉以改善小農地區之灌溉排水效率

#### 考量條件

- 在亞洲區域大多數的糧食都是由小農所生產，而這些小農屬於最貧窮人口的一環。
- 都市化使灌溉地變更為非農業用地。
- 農地所有權經過不斷的轉換後，往往由非農民取得了農地。
- 都市化提高小農對商業及非農業收入機會之依賴性。
- 受過良好教育的年輕人對繼續從事小農經營逐漸不感興趣。
- 都市人口快速成長改變了生活水準，象徵糧食需求大幅增加。

#### 認知

- 由於土地變更，亟需改善土地及水資源之生產力，以改善小農生活並達成糧食安全之目標。
- 必須優先考量提升灌溉與排水效率，以改善小農生計。
- 需要非農業收入以滿足小農之基本需求。
- 小農之財力有限，其無法支付灌溉服務費，更無能力投資改善灌溉技術。
- 需要更具彈性的耕種制度，以因應日益加劇的氣候變異與缺水危機。
- 在水資源管理與防洪系統中之集水區、河流及灌區等地，需要更完善的環境管理。

## 我們呼籲

- 政府：
  - 主導各項農業政策及支援計畫，並藉由發展當地農產品產業，建構可行的農業信用系統及市場機制，以創造更多具永續發展之非農業性質的工作機會。
  - 促進用水者協會及聯邦用水者協會發展成爲兼顧水資源、農業及生態系統等方面之整體管理者，並爲環境的守護者。
  - 拓展願景並促進小農制度順利轉型成爲商業性的農村企業。
- 知識機構：
  - 經驗分析並發展最佳的實行方法，將用水者協會/聯邦用水者協會提升成爲綜合水資源、農業及生態系統等方面之管理者。
  - 從各國汲取經驗並發展最佳實行方法，協助訂定中、長期的轉型計畫，從小型農業經營轉成爲大規模的商業性農村企業及農產相關事業。
  - 發展並引進小農財力足以負擔的新技術，以提升用水效率、因應氣候變遷及環境保護，提高小農生產力並改善其生活。
- 農業服務及灌溉排水管理機構：
  - 扮演提供農業服務角色，有效地整合小農用水者協會/聯邦用水者協會成爲夥伴關係，對於因應都市化、工業化、土地變更及氣候變遷等課題，共同進行開發及管理事宜。
  - 接受企業活動以提高農村參與的價值鏈，並說明城鄉生活之差距。
- 國際組織及金融機構：
  - 促進資訊交換、研究、技術轉移及國際化，以協助小農及灌溉者在快速都市化及工業化社會下，面對從事農作之挑戰與選擇。

## 二、技術考察

### (一)印尼簡介



印尼為全世界最大的群島國家，其包含蘇門達臘島(面積 473,606 平方公里)、爪哇島(面積 132,107 平方公里)、加里曼丹島(面積 539,460 平方公里)、蘇拉維西島(面積 189,216 平方公里)、巴布亞(面積 421,981 平方公里)等五大島以及 30 幾群較小的島嶼，全國共計 17,508 個島嶼，居民主要分布於其中約 6,000 個島嶼。

印尼估計每年從分布在各群島的 5,888 條河川中之可取水量約為 25,300 億噸，其中目前每年可用水量約為 1,570 億噸，農業用水約占 80%，民生及工業用水占 20%。

根據統計，考慮印尼當地之土壤適灌性、可用水量、農民人數等因素，約有 1,100 萬公頃土地具有發展為灌溉農業可耕地之潛力，但實際上只有 750 萬公頃為已開發的灌區，此外，另有統計資料顯示位於蘇門達臘、加里曼丹及巴布亞島東岸具有發展潛力的沼澤溼地面積約共有面積 3,340 萬公頃，其中內陸沼澤面積為 1,330 萬公頃，感潮濕地面積為 2,010 萬公頃。

## (二)印尼灌溉事業發展概況

早在印度教徒入遷之前，印尼灌溉事業就已經發展一段時日了，西元第5世紀時期，當地居民分別在雅加達北部的 Cilincing 及東部的 Bekasi/Cakung 河流捷徑等地區建造了許多灌溉基礎設施，至今仍具盛名。西元 808 年，位於東爪哇島布蘭達斯河流域的 Harinjing 村，爲了讓人民得以在此居住，便在當地河川建造堤防作爲分水灌溉與防洪設施，此爲印尼東爪哇島最早設置之灌溉設施，西元 1350 年進行該設施之修復，使其重回原貌。而印尼歷史最悠久之常年灌溉設施爲建造於西元 1826 年位於西蘇門答臘島之 Batang Mimpri 壩，接著是西元 1832 年於東爪哇島上所建造之 Sampean 壩。

印尼於西元 1969~1994 年間進行加強灌溉系統整復及發展工作，其中分別進行了面積規模 260 萬公頃、170 萬公頃及 200 萬公頃等 3 次新開發地及農田之整復及發展工作。根據印尼 2002 年統計資料顯示，其水田灌溉總面積約爲 780 萬公頃，作物密度爲 1.35%，除了主要作物稻米總產量達 4,880 萬噸外，同年次級作物包括玉蜀黍、大豆及花生的產量分別爲 950 萬噸、95.3 萬噸及 72.2 萬噸。

## (三)印尼日惹—莫拉比火山【Merapi Sabo Dam】技術考察

### 1.參訪行程：

- (1)莫拉比火山（Merapi Volcanic Mountain）區北面之 Tlatar Sabo Dam
- (2)莫拉比火山區北面 Ketep Pass Volcano Center
- (3)Borobudur Temple（婆羅浮圖）
- (4)莫拉比火山（Merapi Volcanic Mountain）區之 Sabo Dam Boyong River  
— Check Dam 及灌溉設施、
- (5) Merapi Museum

### 2.莫拉比火山簡介

Merapi Volcanic Mountain（莫拉比火山）位於日惹市北方約 30 公里，是印尼 129 座活火山中最活躍的火山。Merapi 印尼文的意思即爲「火之山」，其高程爲 2941 公尺，噴發週期約 3-7 年，其噴發之火山熔岩及氣體溫度高



達 900-1200°C，自從 1548 年起，已經斷續噴發了 68 次。火山距離日惹市相當近，山麓居住著幾千人，有的村莊在海拔 1700 米的高處，由於其威脅人類居住地的安全，被國際地球化學和火山學協會列為應當加強監督與研究的全球 16 座火山之一。



圖 1 莫拉比火山

主辦單位印尼公共事務部( Ministry of Public Works )安排參觀 Sawangan 地區之 Ketep Pass 火山中心，該中心為印尼政府最早設立之火山展示中心，內部陳設有 Merapi 火山歷年來火山爆發時熔岩移動路徑及受影響區域之資料，同時亦展示 Merapi 火山體之 1:825 模型、火山噴發照片、印尼活火山基本資料等。Merapi 火山一般每兩到三年都有一次小噴發，每 10 至 15 年會有一次大噴發，嚴重的噴發發生在 1006 年、1786 年、1822 年，1872 年發生一次最大的噴發，和 1930 年的噴發一起造成 13 個村莊的毀滅，死亡 1400 人。展示中心可觀賞 Merapi 火山影片介紹，從影片中可見火山噴發對當地民眾生命財產的為害，也感嘆大自然的力量。



圖 2 由衛星影像看莫拉比火山及臨近之火山群

由於火山碎屑物與火山灰富含豐富的有機、無機物，土壤肥沃，因此火山噴發後，人民冒險採火山灰土壤種植作物，拿石頭雕刻，也因此 Merapi 火山錐體坡面上，農民種植相當多的農作物，也有多處農村，這些都是印尼當地民眾順天適應自然環境變遷的生活方式，影片最後一段文字寫到：「火山是上天送給印尼人的禮物」。

另主辦單位亦安排 Merapi 火山區南方於 2009 年 10 月 1 日開放之 Merapi Volcanic Museum，它是兩層的建築物，由於該博物館剛開放，因此二樓的展示空間尚未對外開放。博物館一樓分成數個展覽主題，包括世界及印尼火山分布情形、Merapi 火山歷年來噴發歷史與火山口變化情形、火山對印尼之危害、地震與海嘯、火山監測設備、印尼早期火山災害預警防災系統及現代化防災系統等，為一兼具歷史、教育與防災之多功能博物館。

## 2. 莫拉比火山之監測預警系統

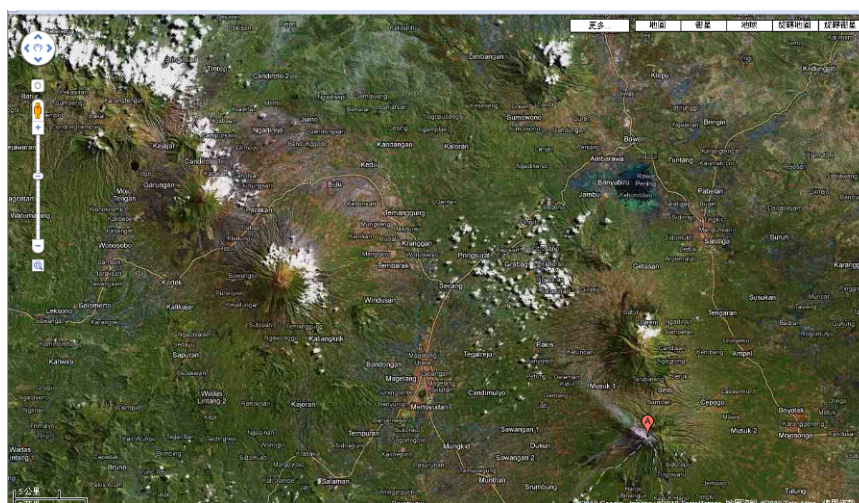
Merapi 火山從 1924 年就開始舉行地震波監測，1930 年的噴發證實在噴發前有強烈的地震活動。目前有一套相當完整的監測系統在火山周圍有 8 台地震監測儀組成的監測網可以讓地震學家確定震源，震源在地下 1.5 千米以下不會被發現，可能是因為震波被岩漿所吸收的原因。此外還監測地磁的變化，地磁的變化也預示著岩漿的漲落，可以預測火山的噴發。地震波監測還可以確定泥石流的發生，高頻地震波經常預示會發生泥石流，如果降雨超過每小時 50 毫米，在火山地區就回發生破壞性的泥石流。另外也針對噴發之氣體進行監測(圖 3)。



圖 3 氣體監測記

目前也依照監測數據訂定不同的警戒等級，當等級達到三，則民眾需強行撤離，2010.10 的噴發，已經達到警戒等級三。

此預警系統成功預警 2006 年的火山噴發，將傷亡人數有效降低至人，但 2010 年的噴發則未預警成功，造成至少 30 餘人的傷亡。

### 3.莫拉比火山之泥石流防堵工程

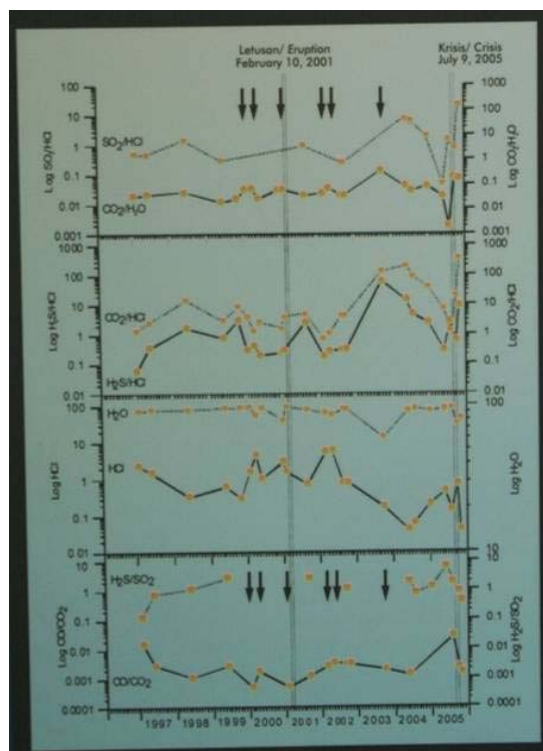
由於火山噴發會伴隨的高速的火山灰流和火山泥流會對下游居民帶來威脅，且火山噴發後之火山灰於降雨時會造成下游嚴重之泥石流災害，因此印尼政府於莫拉比火山之河道位置興建大量之土石壩，以減緩災害發生。目前規劃興建的防砂壩達 200 餘座，興建完成的已有 176 座，其分佈位置如圖 4。



圖 4 防砂壩位置圖

防砂壩之型式如圖 5 及圖 6，具有減緩水流速度、減緩河床梯度、避免橋樑基礎的局部沖刷等作用，另外部份防砂壩也兼具灌溉取水功能(圖 7)。



圖 5 防砂壩(與道路共構)



圖 6 防砂壩型式



圖 7 灌溉渠道

#### 4.聖山

火山下方為一遼闊的平原，根据印尼當地的神話，這塊區域即 Kedu 平原是爪哇的聖地，因其土地肥沃而被冠以“爪哇花園”，雖然許多生命因火山頻繁爆發而失去了，但由於土地肥沃，因此當地居民仍然喜歡住在該地。

蘇丹王還任命專門的神職人員，負責莫拉比火山的祭祀工作，並且安撫其情緒，以避免或降低噴發造成的傷害。當地居民每年也有固定節日祭拜火山。讓我們於火山無情災害與可怕的認知外，增加了另一個面向的思考。



圖 7 火山下的村莊

## 5.後記

Merapi 火山的噴發以及帶來的災害，與國內之土石流災害有幾分類似，目前火山所採用的預警制度及應變措施之邏輯，亦與土石流相近。參訪過程中看到印尼對相關火山展示及介紹，相當完備，讓我們可以清楚認識火山的成因及相關知識。

惟今年參訪回國後 10 天，Merapi 火山再度爆發，並帶走 30 餘人命，負責祭祀安撫火山的神職人員在罹難前仍在祭祀安撫火山，讓人不勝唏噓。



圖 8 聖山(Merapi 火山)

#### (四)印尼日惹—稻米耕種計畫【Project SRI】技術考察

##### 1.參訪行程：

- (1)Garongan 地區管路灌溉系統
- (2)Sidorejo 地區 SRI 試驗計畫
- (3)Plaosan Temple 水利工程遺址復原計畫
- (4)Prambanan Temple

##### 2.Garongan 地區管路灌溉系統

Garongan 地區由於距離印度洋海邊約 1 KM，早期為砂丘地不毛之地，近年來政府投資興建灌溉蓄水池，並於農地下方埋設灌溉 PVC 水管，由於該地區地質為砂土、且有 Merapi 火山產出之有機質，因此土壤肥沃，復以農地充足之灌溉水量，作物生長情形良好，目前已成為當地種植蔬菜、水果重要地方，也改善農民的生活。Garongan 地區管路灌溉系統設備雖較台灣簡陋、灌溉系統自動化程度也低，在當地水利工程師因地制宜，利用高程能量差原理，亦能達到節省人力的灌溉方法。



圖 9 Garongan 管路灌溉施作情形

### 3. Sidorejo 地區 SRI 試驗計畫

SRI 水稻栽培方法 (System of Rice Intensification) 係由法國人 Fr. Henri de Laulanie 於 1983 根據在馬達加斯加協助農民改善稻作技術的經驗而提出的方法，目前正在全球稻米生產國家推廣並尋求世界各個稻米生產國家的認同。該方法之原理為藉由改變作物、土壤、用水與營養管理，使現有的所有稻米品種都會因此變成具有較高生產力的品種，可以在較短時間內獲得較高產量，並且僅需要使用較少的灌溉用水。此外，有許多缺乏灌溉設施的國家與地區，也出現了依賴降雨形態的 SRI 栽培方式，而且，SRI 栽培方式也可以應用於提升其他作物之產量，亦可見其應用層面的廣度。對過去幾個世代的人們來說，一般相信採取持續漫灌的耕作方式，可獲得較好的稻米產量與品質。然而，經由 SRI 栽培方式的試驗所獲取的科學數據，顯示了水稻並非大眾所認知的水生作物。當水稻長時間生長於需氧土壤中時，水稻將更為健康且對病蟲害更有抵抗力，甚至可以抵抗像颱風等風災的侵襲而不至於倒伏，並且可以更為耐旱，忍受極端溫度與其他來自氣候的壓力。這些功效主要是來自於較好且較深的根系生長，以及大量、多樣且活躍的土壤生物群。SRI 對於如何改變作物管理技術已經有進一步的了解，包括改變用水管理可增進稻米的產量與品質。SRI 栽培方式為農夫們創造了減少灌溉用水支出的誘因，因為他們如果採用 SRI 栽培方式，便可使用較少的灌溉用水卻能獲取較高的稻米產量。



圖 9 SRI 水稻栽培示範區

SRI 六個基本概念為：1.提早插秧時間以維護秧苗生長潛勢（目前亦有實驗直播法）。2.避免損傷秧苗根部。3.提高秧苗之株距。4.保持土壤適當的水分但不長期浸水。5.儘可能維持通氣狀態。6.加強土壤之有機質。與台灣現行水稻種植方法，主要的不同在於：1.灌溉僅維持土壤濕潤，田間無湛水，每一期作應可節省可觀水量；2.土壤透氣度提高，促使水稻根系充分發展；3.插秧的間距擴大，每一位置僅插一株秧苗；4.由於田間無湛水，雜草容易滋生，需要更多的人力管理；5.採用有機栽培方法，以自製的天然肥料施肥，並不噴灑農藥，強調自然方法；6.由於有機栽培方法與微潤的土壤，田間具有更豐富的生物多樣性。依據 SRI 在全球各地試驗結果顯示，SRI 栽培方法可增加產量 50~100%、減少灌溉用水約為 25~50%、降低生產成本約 10~20%、提高稻米碾製率 15%，減少破碎米粒、減少化學肥料使用量、由於根部系統發展狀況良好且土壤通氣情形較佳，抗病蟲害亦較佳。



圖 9 SRI 水稻栽培作物生長情形

1997 年美國康乃爾大學食品和農業發展國際學院（The Cornell International Institute for Food, Agriculture and Development (CIIFAD)）Norman Uphoff 教授開始於印尼推廣 SRI 栽培概念，這是 SRI 栽培方法首次出現於馬達加斯加以外的國家，1999 年首次於印尼及中國辦理現地試驗，其後逐漸在亞洲、非洲及拉丁美洲等地區推廣，迄今 2010 年止全球已有 40



個國家在辦理 SRI 推廣試驗工作，平均每公頃產量達 7-10 公噸。

在印尼年灌溉用水量為 1170 億噸，約佔全國總用水量的 81%，進一步分析，85% 灌溉用水用於水稻栽培，也就是說水稻灌溉用水量約佔印尼全國年總用水量的 70%（台灣約為 60%，與日本相當），由於印尼亦面臨氣候變遷水資源競用的問題，因此印尼政府大力推廣 SRI 栽培方法，以降低灌溉用水量。印尼 1999 年由 Agency for Agricultural Research and Development（AARD）首先西爪哇 Sukamandi 水稻研究中心試驗，2001 年於西爪哇 Ciamis 地區開始於田間種植，到 2007 年西爪哇地區已經有 9,829 為農民實施有機 SRI 栽培方法、栽種面積約 2,848 公頃。此外，2002 年開始由日本提供經費、印尼公共事務部（Ministry of Public Works）水資源總署將 SRI 栽培方法在東印尼地區推廣，至 2007 年推廣面積也達 5,000 公頃。

主辦單位安排 Sidorejo 地區由日惹 Gadjah Mada University 技術輔導之 SRI 試驗計畫，該試驗計畫係結合有機農業栽培方式辦理，從現場展示之試種成果顯示，SRI 栽培方法水稻株高明顯較傳統漫灌方式高，根系發展也比較好，經訪談當地農民均表示，SRI 栽培方法確實可增加農民的收益，也對印尼政府推廣之 SRI 栽培方法表示肯定。本次 ICID 會場中，爪哇當地的大學、研究機構等，均設置 SRI 栽培方法試驗成果推廣攤位，顯見 SRI 栽培方法在印尼將成為新的水稻栽培技術，在農業水資源的供應因為氣候變遷、能源價格高漲以及人均耕地日漸減少等衝擊，而變得更加不可靠且更受擠壓時，如何減少灌溉用水需求量已十分迫切且危急。當我們必須重新調整 21 世紀的農業生產策略時，SRI 栽培方式的經驗與想法提供了新的思考方向。

#### 4. Plaosan Temple 水利工程遺址復原計畫

Plaosan Temple，約於 9 世紀中葉興建，主辦單位安排此點目的在於 Plaosan Temple 位於 Dengok 河附近，且鄰近 Merapi 火山，古時為避免洪氾與火山熔岩侵襲，因此於 Plaosan Temple 興建同時即設置砌石排水渠道及灌溉設施。該渠道寬約 8.3 公尺，預估排水量為 10-15 CMS，另由於高程關係，渠道中亦設置沉砂淨水池與灌溉取水堰體，由於年代久遠及受 Merapi 火山噴發之火山灰與熔岩影響，目前已被埋沒，印尼政府正在進行該人工渠道古蹟復建工程，極具教育、歷史與文化上之意義。

### 三、參加會議及技術考察心得

印尼擁有二億多的人口，雖然是開發中國家，可是農業卻很發達，很難想像一個年平均雨量不多的國家，卻有著世界頂尖的灌溉系統與豐富多元的農特產品及與自然生態環境共榮共存灌溉區域。印尼從事農業人口約占百分之四十，屬最多人口的行業。在參觀其相關設施及栽培技術後感覺仍有一段改善的空間，由於赤道貫穿印尼中部屬於熱帶性國家，幾乎全年均可種植稻米，故在沿途可看到不同成長階段的水稻。



灌溉技術運用於農業的生產重要不言可喻，有水源滋潤的農業灌區作物種類及收成量絕對比沒有水源灌溉的農業區作物種類多元化且高收穫量。印尼以極少的年雨量，卻能發展為世界重要的農產品生產地之一，水資源的充分利用功不可沒。這個世界有許國家面臨著饑荒與缺水的嚴重問題，我們台灣仍有著豐沛的水資源及精緻完整的水利系統，更應當好好珍惜自己的生活環境。保護水資源是我們每一個人的責任，我們有義務讓世界變得更美好。

本次大會安排實地參訪(technical tour)到當地推動稻米增產系統的現場觀摩(system of rice intensification, SRI)，該地區約有 15 公頃的推廣示範區，當地居民透過有機堆肥，增加稻米的單位面積的產量，同時也降低化學肥料對環境的破壞。根據統計資料，當地的稻米生產量每公頃最高可達 9,000 公斤，相對於台灣地區平均生產量(6,000~7,000kg/ha)而言，這是非常高的數據。除此之外，由於人力資源充裕所以印尼的 SRI 採用高頻度的灌溉方式，不同於國內旬給水(ponding)的方法，當地幾乎每日給水，若以系統灌溉而言，這類似於利用人力的微灌溉概念了。SRI 理論說來，它並不是一個方法而是一個制度，透過制度的掌控，增加現地稻米的產量，同時減少農業工作對土地的負擔。所以，SRI 在不同的國家，甚至於

不同地區都應該是在地的方案設計(designate solution)，其他地區的經驗可以觀摩，但難以無法轉移抄襲。

國際灌溉排水協會成立迄今已逾 60 年，該組織鼓勵各國家委員會積極招募青年專家與會，除為各議題組成之技術活動委員會工作小組貢獻心力，並傳承該組織之精神。今 2010 年於日惹會議中更強調由青年專家及非政府組織參與之重要性。近年來台灣積極參與國際灌溉排水協會技術活動之相關工作小組會議及論文發表事宜，未來除以既定之工作小組成員為主，應將廣邀青年專家學者，為台灣參與國際灌溉技術交流之工作注入新的生命力。

**daily NEWS**  
No. 05 / 15 October 2010

**ICID**  
The 61<sup>st</sup> IECM and The 6<sup>th</sup> ARC

**TAIWAN ALWAYS ENCOURAGE THE YOUNG PROFESSIONALS**

Taiwan delegation seems to always be one of the largest groups in every ICID conference. "We always send a representative of more than 20 people," said one delegate. This year in the 61st and 6th IECM ARC of ICID held in Yogyakarta, Taiwan sent 27 participants from various institutions, such as universities, consultants, irrigation association and also the government. This year Taiwan showed regeneration of approximately 20 participants because it was the first time they follow the international and regional conferences. Taiwan also always encouraged the young professionals to be actively involved in a lot of programs, activities and conferences.

In the 61st IECM and 6th ARC of ICID in Yogyakarta, some delegations from Taiwan also participated to present their papers in the working group. One of them is Professor Hsiao-Wen Wang from National Cheng Kung University.

In organizing its participation in the international and regional conferences, Taiwan proved to be professional. Since a year ago even they had prepared a book containing a list of all participants at the conference and also selected papers, including the abstracts. Not only that, they also made it two versions in Chinese and English, so it can be understood by all of the participants.

• Ivan Chen, Ming-Young Jan, Chang-Chi Cheng

摘錄自印尼大會發行之 Newsletter：  
鄭昌奇教授、詹明勇教授等人接受訪問表示，台灣積極參與國際會議活動，鼓勵青年專家與會，發表論文。

此行團員對印尼地區水庫維護管理、農作物引水灌溉耕作及國家古蹟景觀維護、自然生態...留下深刻印象，也藉由親身現地觀摩參訪從中獲得相當多的寶貴知識與經驗。

## 肆、建議事項

- 1.積極參與工作小組會議：國際灌溉排水協會各工作小組會議所討論之議題，彰顯該組織的核心價值，透過參與工作小組會議，將提高與國外專業人士之接觸，很快可以得到認同感與爭取曝光的機會。
- 2.廣邀專業人士參與及貢獻經驗：國際灌溉排水研討會議主要探討各國在推動灌溉排水技術及管理之課題，而台灣各個農水利會具有灌溉排水的實務經驗，建議由各水利會從業人員就目前已推動之相關計畫成果，提出較好的案例，再由學者協助翻譯發表於國際灌溉排水大會，讓其他國家分享，兩者相輔相成。凡提出成果報告/論文發表之人員，建議得於次年可優先選派，必要時可推薦成爲國際灌排協會技術活動委員會之工作小組成員，以增加我國在該會議上的工作小組人數，讓水利會人員得以學習更多實務與國際會議經驗，亦擴大國際交流的機會。

本年度與會之各農田水利人員茲於會後提出相關議題，以提供未來台灣學者專家發表於國際灌排研討會議之議題參考：

- (1) 瑠公農田水利會－農田水利會會有資金運用方式之探討－面對低利率環境之因應策略
- (2) 桃園農田水利會－推動陂塘淤積土層分析及應用於農地土壤改良可行性評估
- (3) 苗栗農田水利會－休耕農田蓄水計畫
- (4) 南投農田水利會－南投縣埔里大坪頂地區灌溉計畫
- (5) 高雄農田水利會－推廣節水灌溉成果
- (6) 台東農田水利會－龍田噴灌區爲例「旱作灌溉的奇蹟」

- 3.知識分享與延伸教育：目前我國家委員會已將國際灌溉排水協會之研討會論文摘要中文化與評述引介，並於次年辦理國內講習會議，將國際知識經驗與國內人士分享。建議未來於講習會中增加國際灌排活動宣導與論文摘要撰寫指南，以助於加強提升投稿論文及參與工作小組議題之數量與品質。有關國際灌排活動宣導，擬包括國際灌排協會的一般屬性與未來三年各工作小組的焦點議題，讓各參與單位提前準備相關議題之專題簡報報告或論文。至於論文摘要撰寫輔導工作，可邀請資深人員主講，分享其投稿經驗與撰稿重點，供各屆有意參與投稿灌排協會研討會論文之人士參考。

# 附 錄 一

## 第 6 屆亞洲區域研討會論文發表

提升砂土保水能力之試驗

Experiments on the Increase of Water-Holding Capacity in Sandy Soils

Chang-Chi Cheng, Ming-Young Jan, Hsiao-Jen Huang and Chun-E Kan

(鄭昌奇、詹明勇、黃小珍、甘俊二)



## **EXPERIMENTS ON THE INCREASE OF WATER-HOLDING CAPACITY IN SANDY SOILS**

Chang-Chi Cheng<sup>1</sup>, Ming-Young Jan<sup>2</sup>, Hsiao-Jen Huang<sup>3</sup>, Chun-E Kan<sup>4</sup>

### **ABSTRACT**

There are sandy soils in the western coastal agricultural area in Taiwan. Hence, how to increase the water-holding capacity has been one major issue in that area. The objective of the study is to conduct a series of experiments by various treatments of the soils, as well as various irrigation schemes, in order to improve the water-holding capacity in sandy lands.

The concept of lysimeters is applied in this study for the observation of outflow curves in order to better understand the variation of water-holding capacity. The lysimeters used in the experiments were designed and simulated by plastic buckets with 50 cm in top opening diameter, 40 cm in bottom diameter, and 80 cm in height. 30 liters of water was irrigated without disturbing surface soil while water depth not exceeding 1 cm each time, and the curves of accumulated outflow vs. time were observed and recorded. Five groups of experimentation were prepared, they are, 1)Experimental Station Group, where the sandy soil from local area was used, 2)Reservoir Sludge Group, where the sedimentation from a local reservoir (Shih-Men) was used, 3)Single-layered AX-xxxb Group, where the bio-degradable polymer was placed at 40-cm depth, 4)Mixed-AX-xxxb Group, where the polymer was mixed with local soil, and 5)Mixed-Reservoir-Sludge Group, where the sedimentation from A-Kung-Tien Reservoir was mixed with local soil.

Basically, the shifting trends of the accumulation outflow curves in each set of experiments could be reasonably explained. Among all tests, Group 3 of Single-layered AX-xxxb at the depth of 40-cm depth to simulate the hard-pan in field has reached most acceptable result. However, how to place material at the certain depth in field is another issue.

Keywords: sand, water-retention capacity, lysimeter

---

<sup>1</sup> Associate Professor, Department of Industrial Engineering and Management, Ching-Yun University, #229, Chien-Hsing Road, Chung-Li, Tao-Yuan, TAIWAN, phone: 886-3-4581196 ext. 6117, fax: 886-3-4683298, e-mail: faber@cyu.edu.tw

<sup>2</sup> Associate Professor, Department of Civil Engineering, I-Shou University, Kaoshiung, TAIWAN, phone: 886-910-871580, myjan@isu.edu.tw

<sup>3</sup> Senior Engineer, Chi-Ting Experimental Station for Upland-Crop Irrigation, Water Resources Planning Institute, Water Resources Agency, Taiwan, hsj@wrap.gov.tw

<sup>4</sup> Emeritus Professor, Department of Bio-Environmental Systems Engineering, National Taiwan University, Taipei, TAIWAN, phone: 886-2-27023635

## I. FOREWORD

There're mostly sandy lands in western Taiwan, and the increase of water-holding capacity in sandy lands has become the major issue of this area. The increase of water-holding capacity can be reached by changing the distribution structure of soil particles. The use of infiltration by gravity through irrigation water is further introduced to gradually alter the soil structure, and the water-holding capacity of sandy soil is hence expected to be raised. The concept of lysimeters is applied in this study when water with various clay or silt content is irrigated to sandy lands, and the outflow is observed to better understand the variation of water-holding capacities.

Desertification has been a global issue. Statistical figures of United Nations indicate that over 100 countries and 900 million people worldwide are currently affected by desertification. Characteristics of desertification include low land surface coverage as well as low precipitation, and especially the low water-retention ability has become one major problem in water-shortage areas.

Due to the improvement of irrigation techniques, sandy lands are no longer considered as poor lands. Yet, the inherited shortcomings of low water-retention capacity have still made them incomparable with conventional good lands. As a result, under the conditions of low water-retention capacity, it is the intention of the study to conduct experiments on the increase of water-retention capacity of sands. And the Chi-Ting Experimental Station is selected for the related experiments.

## II. EXPERIMENT LAYOUT

### 1. Basic data

The basic data for the soil characteristics in the experimental site, e.g., specific gravity, bulk specific gravity, void ratio, saturation water content, soil texture, and infiltration coefficients, etc, are shown in Table 1.

**Table 1** Physical properties of the soil in Chi-Ting Experimental Station

Sieve Analysis			Soil texture	Organic content(%)	PH value	Remarks
sand(%)	clay(%)	silt(%)				
95.32	2.50	2.18	sand	1.66	5.87	
Specific gravity	Bulk specific gravity	porosity(%)	Void ratio	Saturation water content(%)	Wilting coefficient	
2.63	1.47	44.12	0.79	29.71	1.37	

### 2. Design of lysimeters

The experiments were conducted in Chi-Ting Experiment Station. The lysimeters were simulated by five specially-made acrylic rectangular container with 50 cm x 50 cm in length and width, and 70 cm in height. A hole was first drilled at the bottom for drainage as well as measurement, followed by installing a drainage pipe, and filling with 2 cm gravels. An layer of un-woven fabric was placed before



the sand from experiment area was put on top, as shown in Figure 1.

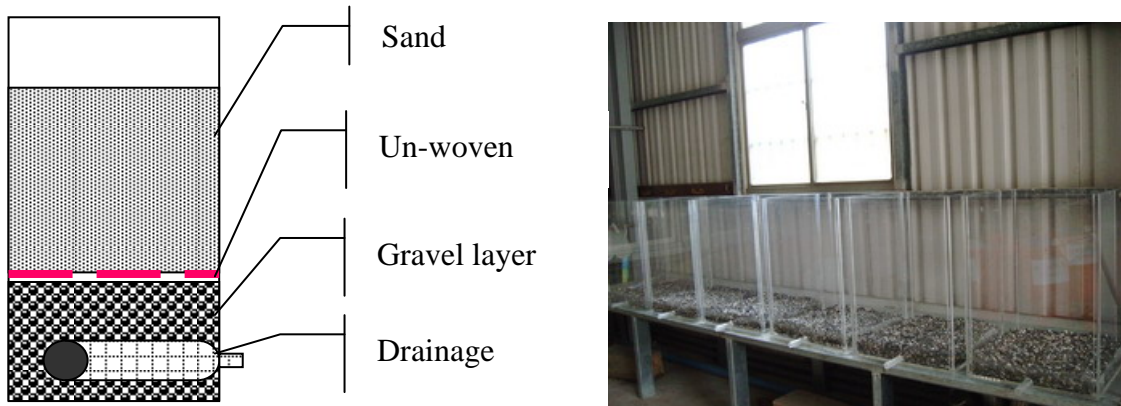

**Figure 1** Design of lysimeter

### 3. Sludge content in the irrigation water

The sludge samples from A-Kung-Tien Reservoir and Shih-Men Reservoir were used as the source for mixing in irrigation water. The sludge was first dried, pounded, and then sieved, before being uniformly mixed in the irrigation water. A control experiment of plain water was also prepared.

### 4. Irrigation plan

It was expected that the voids could be filled with irrigation water, thus a volume of 50 liters was needed for each irrigation practice. Basic principles for the irrigation practice were that the surface soil was un-interrupted, the depth for surface water was under 1 cm, and the sprayer was used for irrigation. The irrigation frequency is based on the water content in the soil, especially the field capacity. And after real operation, one-week was determined as the irrigation period in the beginning, and in the following stages, irrigation was applied according to the degree of cracking after the soil surface was dried.

### 5. Observation and Recording

A stop watch was used to record the discharge time in each irrigation practice, the measurement of record interval as well as the amount of water were adjusted according to discharge condition, and the discharge-time curve was plotted. In addition, an electronic weighting scale connecting to a notebook computer was used in the data collection, and the accumulated discharge-time data were automatically recorded.

## III. EXPERIMENTAL RESULTS AND ANALYSIS

As this was a follow-up study, five groups of experiments were conducted by using the newly-designed transparent acrylic lysimeters. These five groups were:

1. Field Control Group: the local sandy soil was used.
2. Shih-Men Group: the sludge from Shih-Men Reservoir was mixed in the plain water

- and irrigated on local sandy soil,
3. Single-layered AX-xxx Group: a layer of 100g of AX-xxx was placed in the depth of 40 cm to simulate the hard-pan in paddy fields,
  4. Mixed AX-xxx Group: 100g of AX-xxx was mixed uniformly in the experimental soils, and
  5. A-Kung-Tien Group: the sludge from A-Kung-Tien Reservoir was dried, pounded, and sieved, before being uniformly mixed with the experimental sands with the ratio of 1 to 5 by weight.

The preparation and the process of the experiments are shown in figure 2, and the results are described as well as analyzed as follows.



**Figure 2** Preparation of the experiments

### 1. Field Control Group

The plain water was irrigated in the lysimeter filled with local sand from the experimental site. Irrigation was applied in the period of one-week, or when the amount of discharge was small enough, and was continued until the accumulated discharge vs. time curves had reached stable, as shown in Figure 3.

Overall speaking, except in the first application of irrigation in which there was detention effect due to the considerable void volume in the soil particles, there were lag time before discharge, and the discharge volume had reached stable in later experiments. There is significant difference in the accumulated discharge curves between the first application of irrigation and later observations. In the first application, the irrigation water is retained to fill the voids between soil particles. Theoretically, the amount of retained water should be close to the field water

content of the experimental soil.

From observations on the later accumulated discharge curves, it is found that there is a moving trend to the left-upper direction, as shown by the arrow in Figure 3. This phenomenon is the same as the Plain Water Group of the previous study where all curves follow almost at the same track, and it indicates that a stable condition is reached in considerably short time by using plain water for irrigation.

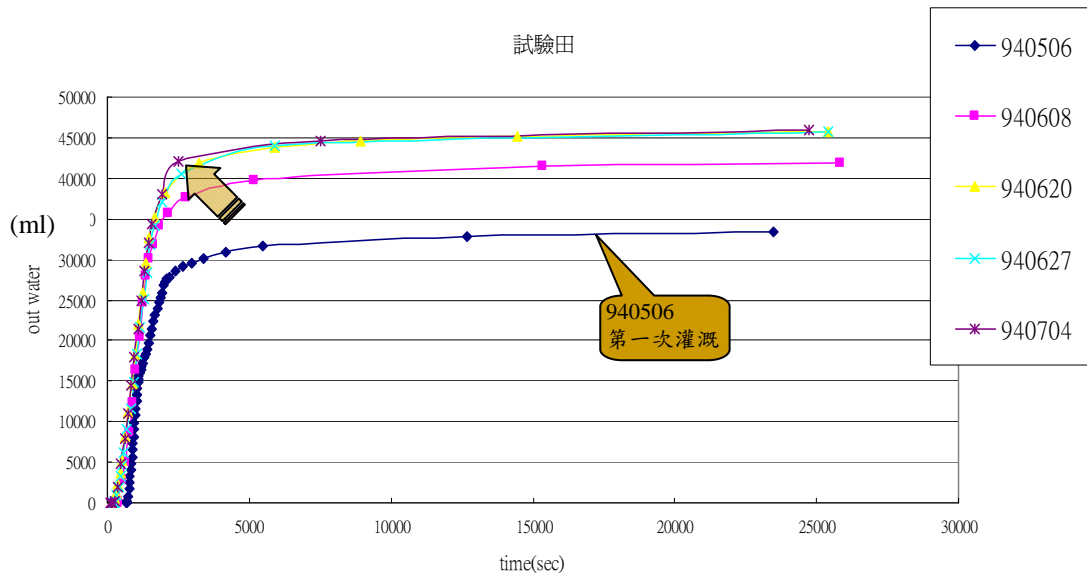

**Figure 3** Accumulated Discharge for Field Control Group

## 2. Shih-Men Group

When the first irrigation was applied in this Group, 50 liters of the original water from Shih-Men Reservoir with sedimentation sludge was used. However, cracking occurred in the experiment sand layer when irrigation was first applied, and all sludge-contained irrigation focused at specific cracked spot, which led to the expansion of cracking spot, and a very thick concentration out-flow discharge was observed, as shown in Figure 4. The outflow discharge became clear only when the cracking was blocked by sludge. The explanation for this is that, the soil particles re-organized when the water with sludge flowed through, and extra space was released. Meanwhile, due to the high concentration of sludge in the irrigation water, the van der Waals force was stronger to keep the surface in shape. But cracking occurred when the force failed to withhold gravity, and the cracking extended when irrigation water concentrated to the cracked surface(Figure 5).

## 3. Single-layered AX-xxxb Group,

From the discharge-time curves of the results of Single-layered Group in Figure 6, it could be observed that except during the first application of irrigation, there was 10-liter more of irrigated water being retained owing to the effects of AX-xxxb as compared with the Field Control Group, other applications of irrigation were pretty much the same. It was almost confirmed that there was 100 times of

water-holding capability (I.e., 10,000g of water could be retained by 100g of AX-xxx) when the AX-xxx was mixed with sandy soils. In addition, it was expected to have even better water-holding capability if the irrigation interval between first and second application of irrigation could be shortened.

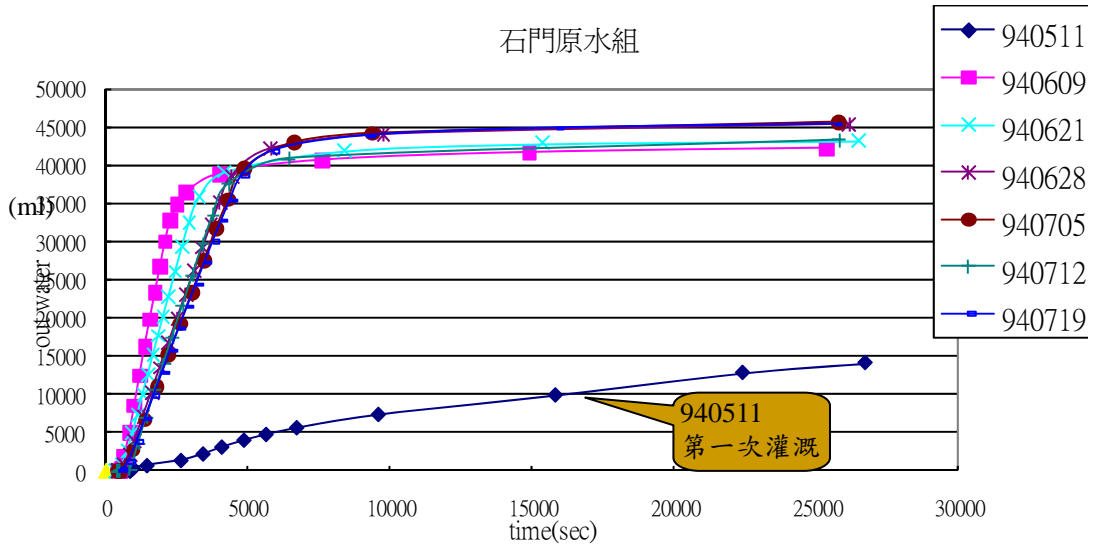

**Figure 4** Accumulated Discharge for Shih-Men Group



Surface cracking when irrigation is applied (side view)



Surface cracking when irrigation is applied (top view)



Gradual expansion of Surface cracking



High concentration of sludge in the outflow at the beginning

**Figure 5** Formation of cracked surface in Shih-Men Group

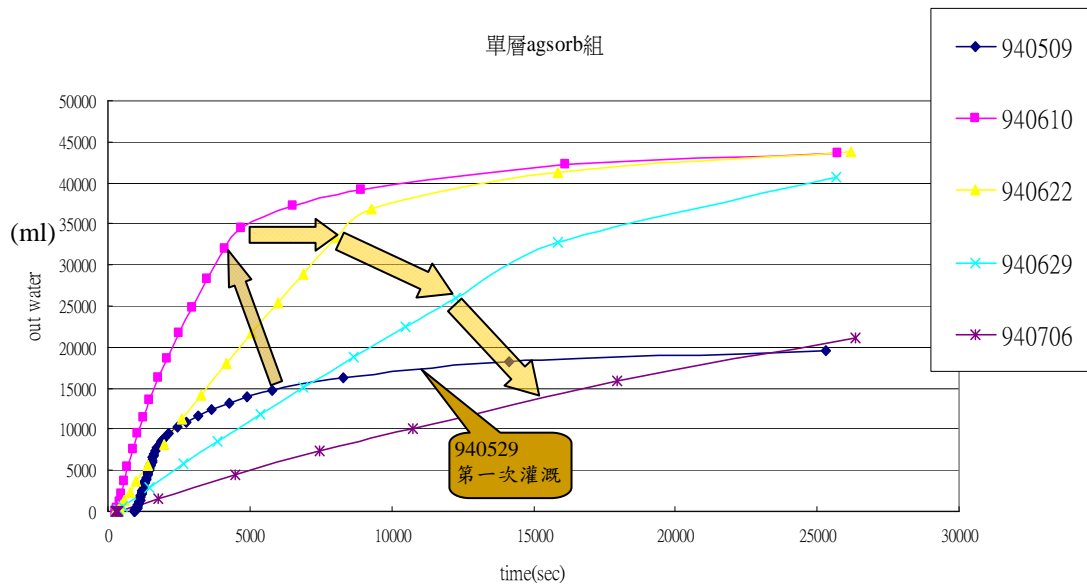

**Figure 6** Accumulated Discharge for Single-layer Group

#### 4. Mixed AX-xxx b Group

The discharge-time curves of Mixed AX-xxx b Group were shown in Figure 7.

When the accumulated discharge curves of this Group in Figure 7 were compared with those of Single-layer in Figure 6, some interesting phenomena could be observed:

- (1) There is a superb water-holding ability of AX-xxx b.
- (2) When the hard-pan is simulated by the single-layered AX-xxx b, the results were surprising. The curve at the beginning was similar to the Plain Water Group. But when AX-xxx b had absorbed enough water, and had reached bonding effect, the later part of discharge curves almost stayed at the track of one single line, which was very similar to normal paddy fields.
- (3) From the aspect of water-holding ability, the single-layered group was far better than the mixed group. However, when the practical application to the field is concerned, how to put the AX-xxx b in place is one major issue.

#### 5. A-Kung-Tien Group

The discharge-time curves of A-Kung-Tien Group were shown in Figure 8.

According to the curves in Figure 8, it could be observed that during the first application of irrigation, the lag time for outflow discharge was delayed for nearly one hour, while the amount of accumulated outflow discharge was obviously less than those in other groups. The explanation for it was that the sludge from A-Kung-Tien Reservoir had been ovened as well as pounded to powder before being imported to the lysimeter, and the water content was nearly 0. Instead, the soils in other groups were only air-dried, and was still containing certain amount of moisture. As a result, there was more space in this Group for absorbing more water during the first application of irrigation. And the following applications had longer

outflow time, and slower discharge speeds, which indicated the remarkable improvement of water-holding capacity.

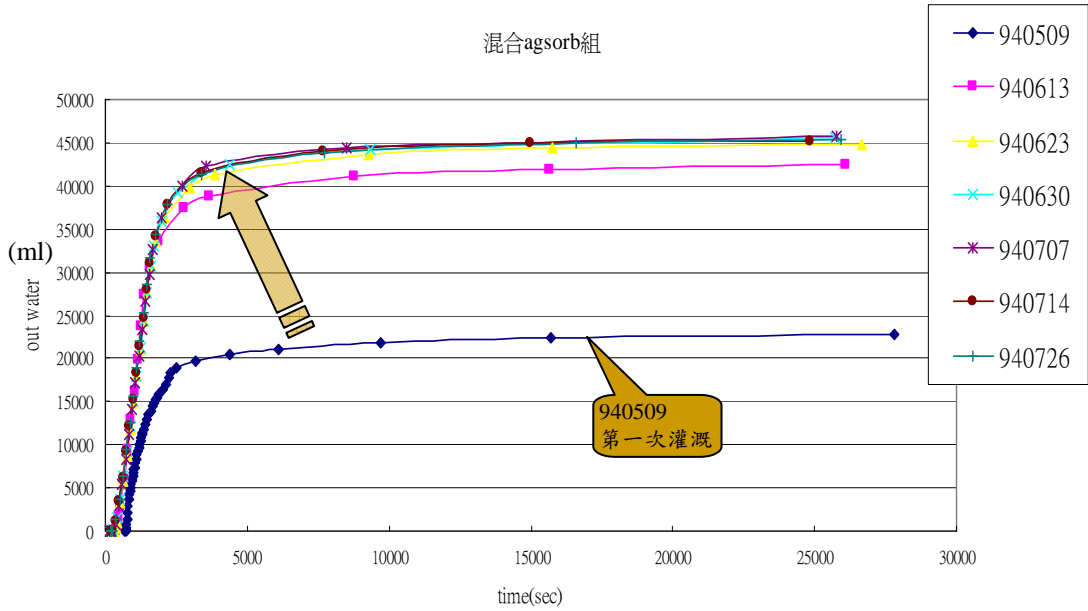

Figure 7 Accumulated Discharge for Mixed AX-xxx Group

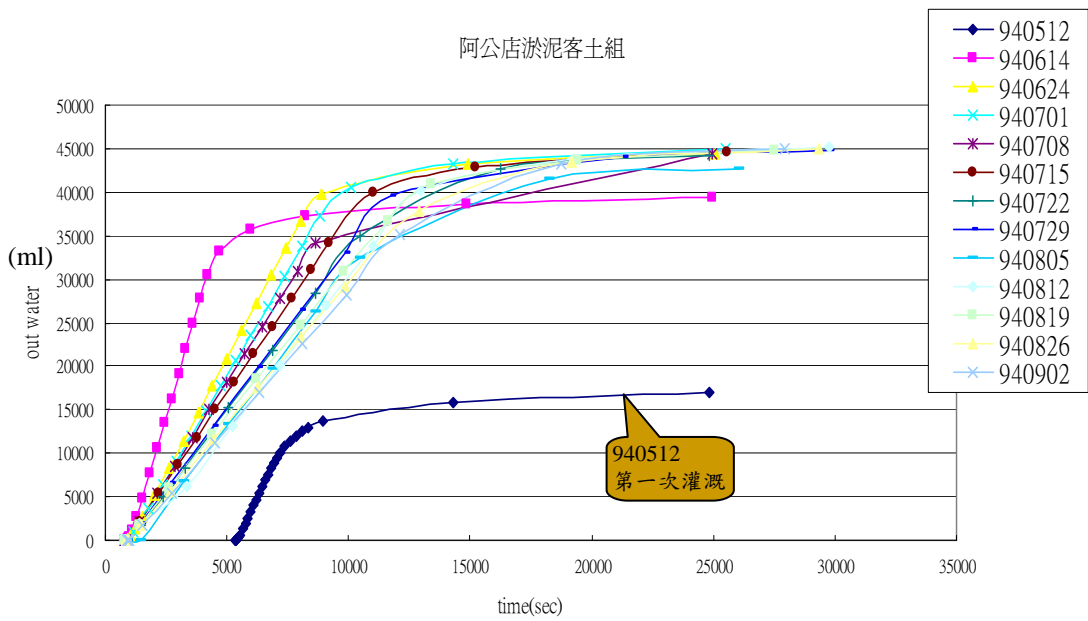

Figure 8 Accumulated Discharge for A-Kung-Tien Group

#### IV. CONCLUSIONS AND DISCUSSIONS

1. The objective of the study with series of experiments is in an attempt to improvement the water-holding capacity on sandy soils.
2. Importing soils from outside is one of the major ways to improve the soil water-holding capacity. However, the shortcomings of high cost and probable impacts on the environment have made it difficult to promote at this moment.
3. The five alternatives of experiments adopted in this study are all able to improve the water-holding capacity of sandy soils. The rankings in terms of water-holding capabilities are: Single-layered AX-xxxb > A-Kung-Tien Group > Shih-Men Group > Mixed AX-xxxb > Field Control Group, and there are significant difference between the first two groups.
4. The AX-xxxb samples adopted in this study is a polymer product from corn, and was developed to relieve the excessive harvest of corns. The benefits of this polymer product include a high water absorbing ability of 300 times by volume, and more importantly, being bio-decayable in 3-4 years.
5. The soil samples from various depth layers were taken before and after the experiments, and soil texture analyses were conducted. However, there were no evident changing trends could be observed from the data obtained. Explanations for this could be:
  - (1)There were indeed no obvious changes.
  - (2)There were sampling errors.
  - (3)The accuracy of the experiments and analyses had not been met.
6. It is suggested that experiments of using various media materials to increase the water-holding capacity should be continued, and further experiments of crop plantation to better understand the effects of the alternatives on crop growth should be followed-up.

#### REFERENCE

1. Cheng, Chang-Chi, Wei-Taw Lin, Yu-Chuan Chang, and Chun-E Kan, 2009. Study on the Increase of Water-Holding Capacity in Sandy Soils. 60th IEC Meeting and 5th Asian Regional Conference, 6-11 December 2009, New Delhi.





## 附 錄 二

### 第 6 屆亞洲區域研討會論文發表

台灣農業回歸水再利用之調查、評估及操作管理之研析  
Investigation, Assessment and Operation Management of the Reuse of  
Agriculture Return Water in Taiwan

Chien-Pang Liu, Wen-Hao Tesi, Kuo-Cheng Hsien, Fang-Tse Tao

(劉建邦、蔡文豪、謝國正、陶方策)



# INVESTIGATION, ASSESSMENT AND OPERATION MANAGEMENT OF THE REUSE OF AGRICULTURE RETURN WATER IN TAIWAN

Chien-Pang Liu<sup>1</sup>, Wen-Hao Tesi<sup>2</sup>, Kuo-Cheng Hsien<sup>3</sup> and Fang-Tse Tao<sup>4</sup>

## Abstract

Controlling the amount of total water usage and sustainable use are major considerations for water resource management policy in Taiwan. Following these considerations, water resource diversification usage is a major direction for water resource development. We examine the possibilities of irrigation water reuse, including site investigation and evaluation for the quantity and quality of the return water, and the water treatment technique and cost analysis. The research result could be help to enhance the usage efficiency of the irrigation water in Taiwan.

## Introduction

Controlling the amount of total water usage and sustainable use are major considerations for water resource management policy in Taiwan. Following these considerations, water resource diversification usage is a major direction for water resource development.

According to recent research, the amount of return water from rice paddies is 2.6 to 3.0 billion cubic meter per year in Taiwan, which is about 25% ~ 30% of all total irrigation water. Most of the drainage water flows into downstream drainage systems and eventually into the sea. Owing to the shortage of water resources in Taiwan, we have been examining ways to collect and recycle the remaining water from the end of the irrigation drainage. This research includes water quantity, quality, potential users, water treatment and techniques for return water collection.

---

<sup>1</sup> Manager of Hydraulic and Ocean Department , Sinotech Engineering Consultant

E-mail: [liupang@sinotech.com.tw](mailto:liupang@sinotech.com.tw) ; Tel: 886-2- 27698388-11210 ; Fax: 886-2- 8761-1595

<sup>2</sup> Technical Manager of Hydraulic and Ocean Department , Sinotech Engineering Consultant

E-mail: [wenhao@mail.sinotech.com.tw](mailto:wenhao@mail.sinotech.com.tw) ; Tel: 886-2- 27698388-11247 ; Fax: 886-2- 8761-1595

<sup>3</sup> Senior Engineer, Hydraulic and Ocean Department , Sinotech Engineering Consultant

E-mail: [kch@mail.sinotech.com.tw](mailto:kch@mail.sinotech.com.tw) ; Tel: 886-2- 27698388-11238 ; Fax: 886-2- 8761-1595

<sup>4</sup> Senior Engineer, Hydraulic and Ocean Department, Sinotech Engineering Consultant

E-mail: [taur@mail.sinotech.com.tw](mailto:taur@mail.sinotech.com.tw) ; Tel: 886-2- 27698388-11233 ; Fax: 886-2- 8761-1595

## Water quantity of agriculture return flow

- Figure 1 shows the process of return flow from the paddy farm. The water budget equation for the paddy farm can be described as  $I \times [1 \div (1 + S2)] + ER = ET_{crop} + DP + \Delta S + O$ , where  $I$  denotes the irrigation flow,  $O$  denotes the return flow,  $ER$  denotes effective rain,  $ET_{crop}$  denotes evaporation,  $DP$  indicates the deep percolation,  $\Delta S$  indicates the change in the amount of water stored in the pond, and  $S2$  indicates loss rate.

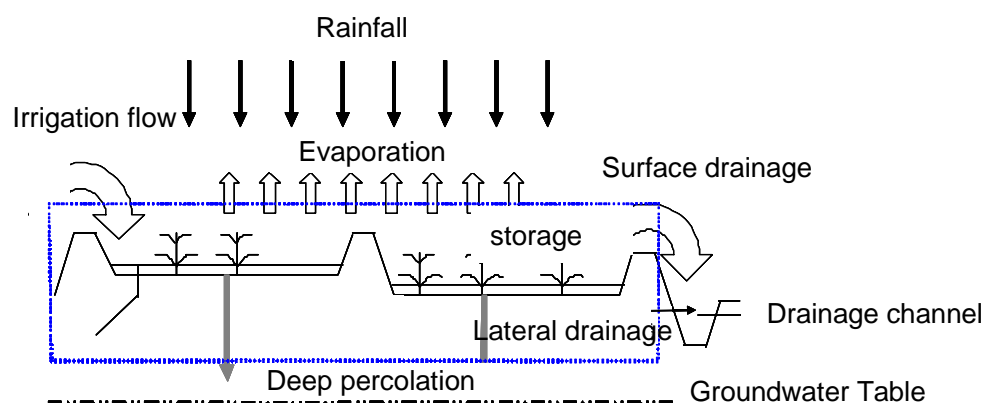

**Figure 1. Water balance in paddy farm**

Calculation results show the average return flow from 2002 to 2007 at about 1.82 billion cubic meters per year in Taiwan. This is separated into 15 irrigation associations as shown in Fig 2. The return water on the eastern side is higher than on the western side of Taiwan, but it is not stable--80% and 90% exceedence probability of return flow is almost near zero in many irrigation areas. Many factors could influence the stability of return water, such as hydrology, water resource of irrigation, groundwater, irrigation methods, irrigation channel distribution, and so on; however, the major reason influencing stability is that farmers do not get water from rivers in non-irrigation seasons in many irrigation areas.

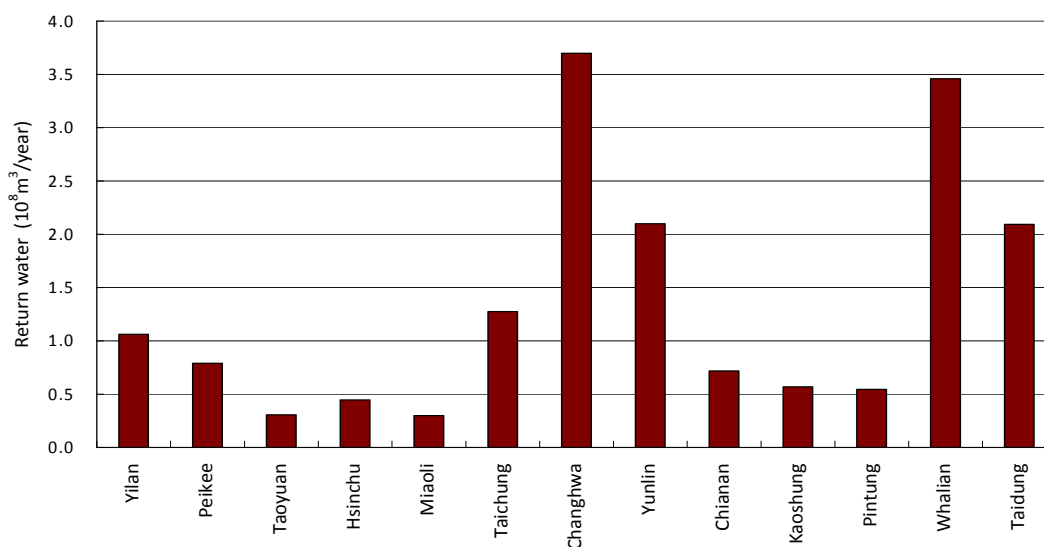

**Fig 2.** Return water in Taiwan

### **Water quality of return flow**

The return flow sampling plan was based on a monthly sampling of irrigation periods in 42 sites during the crop season. The water quality assay of the return flow included pH, conductivity, total dissolved solids, suspended solids, biochemical oxygen demands, chemical oxygen demands, total nitrogen, total phosphorus, turbidity, total bacteria count, E. coli, nitrate, nitrite, TKN, alkalinity, total hardness, chloride, sodium adsorption ratio and heavy metals. Our findings were as follows:

We found that all the agriculture return flows were slightly contaminated by domestic sewage and animal husbandry wastewater. On the other hand, in Nantou, Changhua, Yunlin and Pingtung, the main contamination may have been from farmland fertilizer. In the Tainan area, flows were slightly contaminated by industrial wastewater.

Conductivity of all the agriculture return flows complied with the irrigation water quality standards (750  $\mu$ S/cm). However, in Changhua, Chiayi, Tainan and Kaohsiung, where we found industrial wastewater pollution, the conductivity in the regional drainage was generally not in compliance with the irrigation water quality standards.

Colloid materials, suspended solids and turbidity in the agriculture return flow were higher than the effluent of secondary domestic wastewater treatment plans (SS:10 mg/L), especially in Yunlin, Taitung and Hualien.

Nitrogen levels in northern Taiwan, Hualien and Taitung were in compliance with the irrigation water quality standards (3 mg/L).

The total bacteria count and E. coli concentrations were not in compliance with any water quality standards.

Among the sampling sites, the concentration of heavy metals, such as As, Cd, Cr, Hg, Ni and Pb, were generally lower than the method detection limits (MDL).

### Potential users of agriculture return flows

The desire for users to use agriculture return flow is the key point of this project. It is obvious that water quality requirements are different for different users, such as domestic water, environmental water, agriculture irrigation and industry. Feasibility study results for different users are shown in Table 1. We know that the feasibility is low for domestic water and environmental water, because they are restricted by the binary water supply system and cost. It is feasible for agriculture, and it has already been widely used in irrigation zones. Feasibility for industry water mainly depends on the manufacturing process. There is high potential for reclaimed water to be used as industry cooling water because water quality requirement is relatively low, therefore the cost for water treatment could be more competitive.

**Table 1. Feasibility for different users.**

Users	Evaluation	Feasibility
Domestic	Need binary water supply system	New community is feasible
Environment (Groundwater recharge)	Water quality requirement is high	Low
Agriculture	Widely used in irrigation	High
Industry	Water quality requirement is low. It could be used as Industry Cooling water	Depends on manufacture process

Potential industry users were interviewed about using reclaimed agriculture return water. Their issues and concerns were as follows:

- (1) Cost of reclaimed return flow.
- (2) Dedicated pipelines and storage tanks are necessary for using reclaimed return flow in the factory.
- (3) Stability of the water quality and quantity.
- (4) Human health risk (of the employees who utilize the return flow)

(5) Subsidization for infrastructure.

### Techniques for agriculture return flow collection

Gathering points for agriculture return flows could be located at agricultural or multiformity drainage sites. Comparisons between multiformity drainage and agriculture drainage are shown in Table 2. Facilities to gather water at multiformity drainage sites could be easier than gathering water in agriculture sites, but multiformity drainage includes waste water from industry, city and animal husbandry, thus the water quality is worse and more unstable.

**Table2. Comparison between multiformity drainage and agriculture drainage**

Item	Multiformity drainage	Agriculture drainage
Quantity	Concentrated	Dispersed
Quality	Worse	Better

To reduce the complexity and uncertainty of water quality treatment and gather water before it drains into multiformity drainages would be better. A scenario for return water gathering is shown in Fig. 3. Water gathers at the end of agriculture drainages before it drains into multiformity drainage. This could control return water quality.

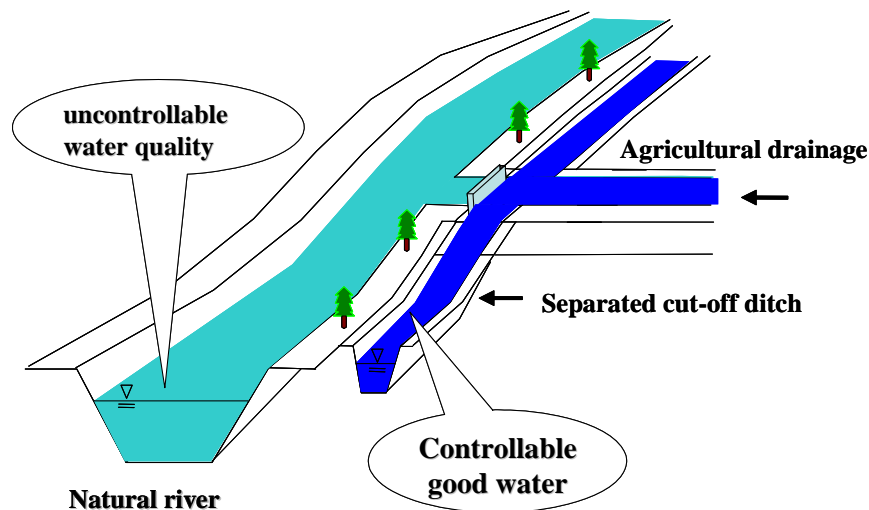

(Reference : Kan CE, Chang YC, 2007)

**FIG 3.** Concept of water gathering techniques

Figure 4 shows the whole water supply scenario for reclaimed return flow. In irrigation users could get water from the return water gathering

channels, and get water directly from rivers in non-irrigation seasons. This could enhance the stability of return water supply.

### Technique for agriculture return flow treatment

Current cooling water systems always loop water 3 to 6 times in modern factories for water conservation, so that assuring the stability of water quality, including dissolved solids (to avoid fouling or corrosion), hardness, conductivity, organic compounds, nitrogen and phosphorus (to avoid bacteria fouling), are very important. General speaking of numerous the agriculture return flow, due to contaminated by domestic sewage and animal husbandry water, the concentration of NH<sub>3</sub>, total bacteria count and E. coli are slightly higher than water quality standards. In addition, the suspended solids and turbidity in the majority of the agriculture return flows are higher than the effluent of secondary domestic wastewater treatment plants (SS:10mg/L). Therefore, in order to make the quality of water more stable, we suggest that a coagulation – sedimentation – aeration – sand filter – disinfection process can be applied. This is an aeration process that degrades NH<sub>3</sub> through “air stripping” in the alkaline state. Noticeably, if the conductivity, TDS or

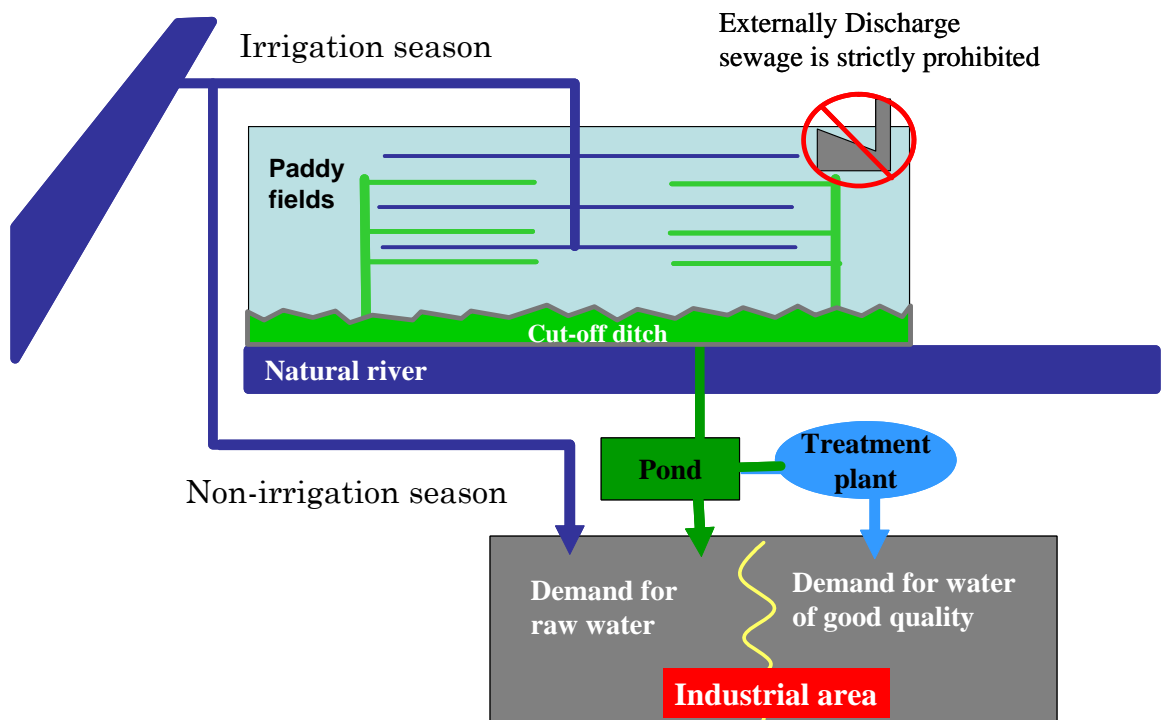

(Reference: Kan CE , Chang YC,2007)

**Figure 4.** Return water supply system



hardness cannot achieve regulatory compliance, then reverse osmosis will be required for desalination.

In setting up water softening or purified water systems for most manufacturers in Taiwan, the influence of water quality is always set to achieve at least “tap water quality standards” or local tap water standards. Therefore, to investigate agriculture return flow reuse for industrial use, “tap water quality standards” was used as a benchmark in this research. The criteria for settling the treatment unit based on water quality standards is shown as Table 4. For evaluating the cost, herein, we only consider the treatment cost (land construction, equipment, and operation/maintenance), which is about NT\$7.5~15/ton.

**Table 4. Process unit requirement analysis**

Process Unit	Water quality standards (tap water quality standards )
Equalization tank	Equalization tank is required for all cases.
Coagulation - Sedimentation	Turbidity > 2 NTU, “Coagulation–Sedimentation” Process is required.
Aeration	NH <sub>3</sub> > 0.5 mg/L, the aeration is required.
Sand filter	Turbidity > 2 NTU, the “sand filter” is required.
Disinfection	E. coli > 6 CFU/100mL, “disinfection” is required.
Reverse Osmosis ( RO )	When TDS > 800 mg/L or hardness > 400 mg/L, the “RO”is required.
Sludge Treatment	Sludge treatment is required for all cases.

## Conclusion

Irrigation water reuse planning needs to consider more factors, including total irrigation return amount, distribution of irrigation drainages, land use, the stability of quantity and quality of return water, and the demand for water users . Our study,shows that irrigation water reuse is feasible through engineering techniques and it is also feasible economically in some irrigation areas as long as is an efficient water management plan for irrigation water usage.

## References

- (1) Chang, YC, CE Kan, GF Lin, CL Chiu, YC Lee. 2001. Potential benefits of increased application of water to paddy fields in Taiwan. *Hydrological Processes* 15: 1515–1524.
- (2) Chang, YC, CE Kan, CT Chen, SF Kuo. 2007. Enhancement of water storage capacity in wetland rice fields through deepwater management practice, *Irrigation and Drainage* 56: 79–86.
- (3) Chang, YC, CE, Kan, GF Lin, CL Chiu, YC Lee. 2001. Potential benefits of increased application of water to paddy fields in Taiwan. *Hydrological Processes* 15: 1515–1524.
- (4) Brouwer C & M . Heibloem. 1986. *Irrigation water needs, Irrigation water management Training manual No. 3*, FAO, Rome, Italy.
- (5) Asano, T. (1998) *Wastewater Reclamation and Reuse*, Technomic Pub., p.528, Lancaster, PA.
- (6) Montgomery, J. M. (1985) *Water Treatment Principles and Design*. Wiley, New York, USA.
- (7) NEWater (2004) <http://www.pub.gov.sg/NEWater>
- (8) Water Resources Agency (2008), *Study on Investigation, Assessment and Operation Management of the Reuse of Agriculture Return Water in Taiwan (1/2)*, Taiwan
- (9) Water Resources Agency (2009), *Study on Investigation, Assessment and Operation Management of the Reuse of Agriculture Return Water in Taiwan (2/2)*, Taiwan

## 附 錄 三

### 第 6 屆亞洲區域研討會論文發表

台灣地區灌溉事業因應氣候變遷調適策略研析

Study on Climate Change Adaptation Strategies for Irrigation Affairs in Taiwan

Ming-Hua Tsai, Wei-Taw Lin, Gwo-Hsing Yu

(蔡明華、林尉濤、虞國興)



# STUDY ON CLIMATE CHANGE ADAPTATION STRATEGIES FOR IRRIGATION AFFAIRS IN TAIWAN

Ming-Hua Tsai<sup>1</sup>, Wei-Taw Lin<sup>2</sup>, Gwo-Hsing Yu<sup>3</sup>

## Abstract

Climate change has caught more and more attention around the world. With the increase in the intensity and frequency of extreme climate events, more catastrophic damage may impact on various water consumers. Accordingly, agriculture, the major consumer of water resource, is predicted to be struck more severely than the other sectors, indicating the importance of agricultural water resource management. However, precipitation in Taiwan is characterized by uneven distribution both spatially and temporally. This feature is predicted to be more significant in the future according to the trend of climate change. Therefore, more comprehensive and provident plans for Irrigation Associations are desired to sustain agriculture from the impacts of climate change.

This study analyzed strategies adopted by other countries and considered in the cropping patterns and environment in Taiwan. Except present adaptation strategies, management should be effectively executed as precaution. Thus, four constructive suggestions were made in this study: 1) improving water use efficiency. 2) Establishing flexible agricultural water allocation mechanisms. 3) Utilizing multiple functions of paddy field. 4) Constructing an early-warning system. With adequate management, the impact of climate change could be diminished. Meanwhile, non-agriculture sectors could be assisted by Irrigation Associations to deal with the threat and opportunity of climate change, building a sustainable future together.

***Keywords: Climate change, irrigation, strategy, small land holder***

---

<sup>1</sup> Director, Department of Irrigation and Engineering, Council of Agriculture, Executive Yuan, Taipei, Taiwan

<sup>2</sup> Section Chief, Irrigation Management Section, Department of Irrigation and Engineering, Council of Agriculture, Executive Yuan, Taipei, Taiwan, E-mail: lwt@coa.gov.tw

<sup>3</sup> Direct, Water Resources Management and Policy Research Center and Professor, Dept. of Water Resources and Environmental Eng., Tamkang University, Tamsui, Taipei County, Taiwan 25137, E-mail: e133@mail.tku.edu.tw

## **Introduction**

In its 4<sup>th</sup> Evaluation Report, the UN Intergovernmental Panel on Climate Change (IPCC) stated that climate change will increasingly worsen the water resources and food security around the world (IPCC, 2007). As the largest consumer of global water resources (around 70%), the world agriculture has been profoundly impacted in particular. With continuing growth of world water consumption on a larger scale (UNEP, 2002), food consumption in each country was predicted to an increment of 9% on average by 2030 (FAO, 2002), and to be compounded by the fact that reduction in food production in major food production countries due to various causes in recent years (IFPRI, 2009), therefore the world food supply would be critically influenced. Thus, many countries nowadays are attempting to ensure food supply self-sufficiency for reason of food security. In this regard, keeping of sufficient water supply rates becomes the most key policy for water resources. Since Taiwan is located in the Asian monsoon region suitable for paddy rice growing with an annual total rainfall highly exceeding irrigation water requirements for paddy, should flexible farming systems and efficient water uses be appropriately practiced and if there are no competitive water uses of other purposes, the water for paddy rice irrigation in this country will be free from insufficiency. Moreover, from the point of view of efficient uses of land and water resources, the paddy fields usually can sufficiently utilize rainfalls not only beneficial to bumper rice production but also helpful to ecological environment in paddy-growing regions including Taiwan in adaptation to climate change. The latter benefits have had substantial effects to related sectors of this country in taking actions for adaptation to the climate change.

Especially in Asia, due to the increasing frequency of occurrences of droughts and other extreme weather events caused by climate change, the availability of water resources will be more unstable. As a result, crop physiology will be impacted by temperature rise as to raise the growing demand of water for agriculture production. For instance, in mid-latitude China, irrigation water demand will be further increased by 6% to 10% for every degree Celsius of the temperature rise (Qin, 2002). Likewise, if Japan expects to maintain current food output, it will need to increase irrigation water by 5% to meet the increment of evaporation (+20%) due to warming temperature (WRD, MoLIT, 2008). Given the situation of limited water resources during dry season in Asia, the issues of assurance of food security while coping with the competitions from industrial and domestic water uses as well as the climate change become imperative and pressing matters of concern, especially for the countries including Taiwan using significant amounts of water for agriculture.

### **I. Impact of climate change on agricultural water resources in Taiwan**

## 1. Water resources in Taiwan

The rainfall in Taiwan averages about 2,500mm per year, which is 2.5 times the world average. However, being a densely populated small island with vast steep hillsides, the water share per capita in Taiwan ( $4,074\text{m}^3/\text{year}$ ) is just one fifth of the global average, ranked as the 18<sup>th</sup> among the most water-deficiency countries. Moreover, it is very difficult for Taiwan to store water for irrigation use, of which about 70 % is drawn from rivers and to allocate and distribute water resources which are attributable to the factors of (1) uneven temporal and spatial distribution of water and (2) distinctive dry and wet seasons (WRA, MOEA, 2005). From observation of the tendency of current climate change, although the total annual rainfalls have not changed drastically in Taiwan, its distribution patterns over the years shows a tendency of more frequent drought and flood events (Figure 1).

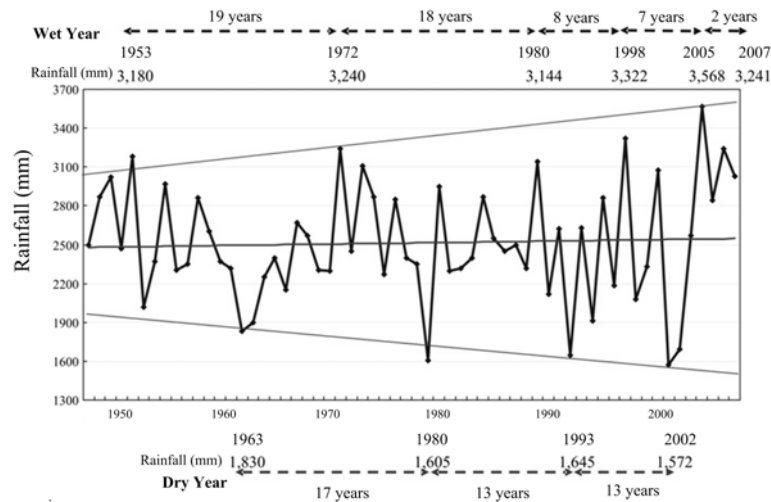

**Figure 1.** Trend of increasing droughts and floods in Taiwan based on observed average annual rainfalls.

(Source: Water Resources Management and Policy Research Center, Taiwan, 2009)

Consequently the rainfall patterns appear to be by and by difficult to meet the water requirements for the existing farming systems, particularly for the transplanting and growing stages of the first rice-crop periods usually in the dry season (Figure 2).

As a result, for the irrigation associations such as the Hsinchu Irrigation Association (IA), which have not any reservoir to store rainfalls in summer season, the adequacy of water supply in their service areas will decrease in dry season (Figure 3).

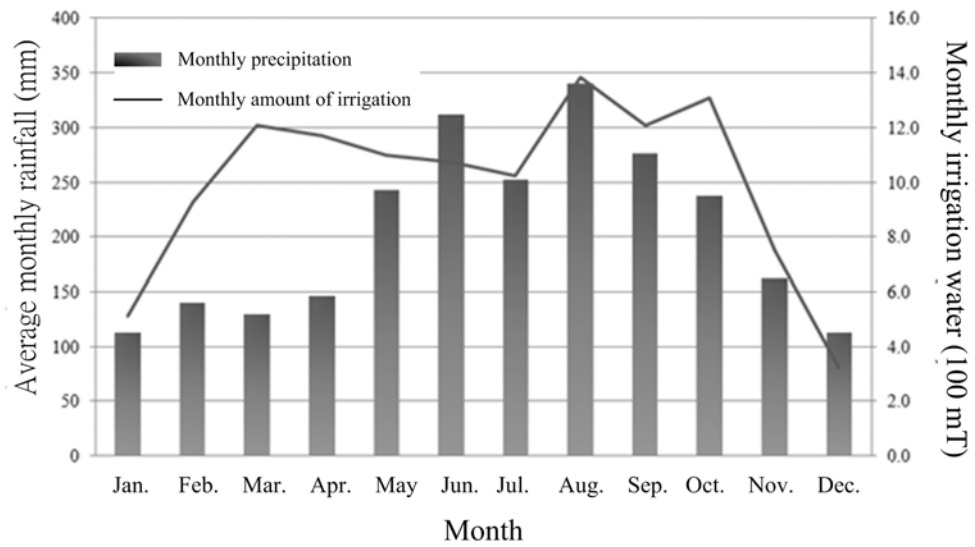

Figure 2. Average monthly rainfalls and irrigation water in Taiwan (from 2002~2008)

Sources:

Rainfall data : Central Weather Bureau, Taiwan

Water consumption data : Council of Agriculture, Executive Yuan, ROC (Taiwan)

(Analyzed by Water Resources Management and Policy Research Center, Taiwan)

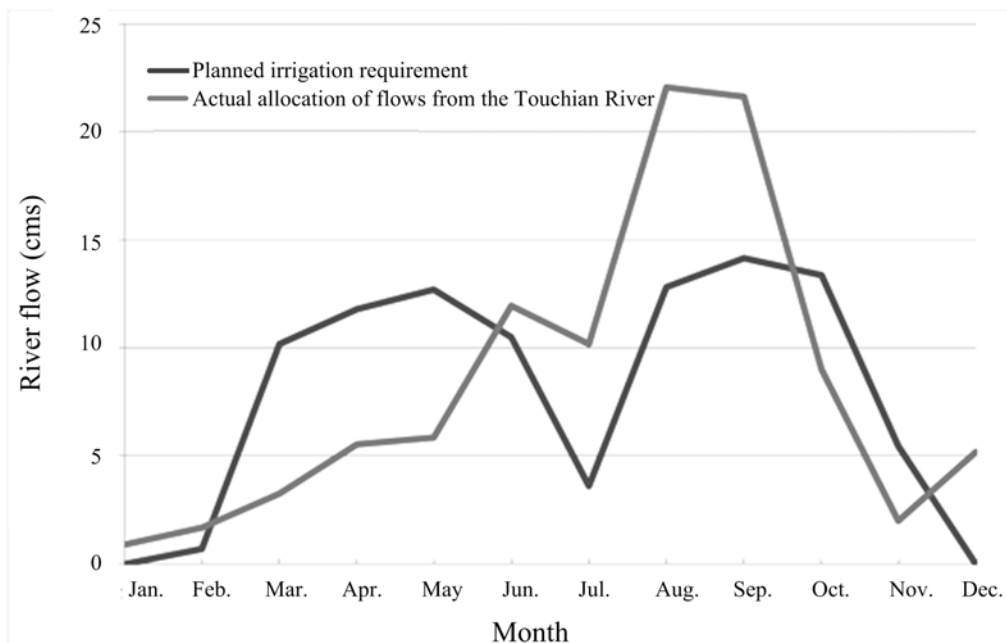
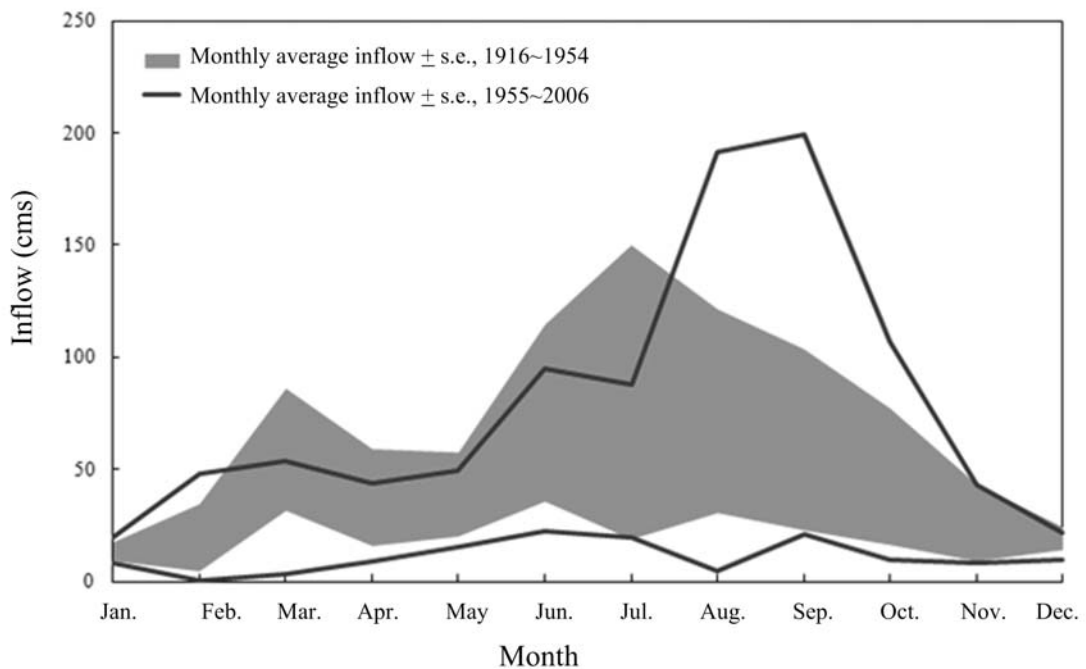

Figure 3. Agricultural water demands and available river flows of Hsinchu Irrigation Association, Taiwan (Analyzed by Water Resources Management and Policy Research Center, Taiwan)



On the other hand, for the IAs like the Shihmen IA, which depend mainly on reservoir water supply, the inflow patterns to the reservoirs originally built for storing water in wet season have changed (Figure 4) and the storage capacities of the reservoirs are menaced by increasingly serious sedimentation due to the climate change. Furthermore, within the service areas of some IAs there have been developed industrial parks and hence have been inhabited with dense population, therefore huge volumes of water have been consumed and suspensions of irrigation thus often happened in recent years. These cases have evidenced that, with or without reservoirs, the water sources of IAs in Taiwan have been influenced by climate change. This notable fact indicates that positive planning of suitable strategies for adaptation as well as mitigation of climate change has to be conducted by Taiwan's agricultural water resources related agencies to ensure adequate water supply in the future.



**Figure 4.** Comparison of the monthly inflow patterns of Shihmen Reservoir, Taoyuan, Taiwan during periods of 1916~1954 & 1955~2006. (s.e.=standard error)

(Analyzed by Water Resources Management and Policy Research Center, Taiwan)

## 2. The impact of climate change on agriculture in Taiwan

The scope of impacts of climate change on the agricultural water resources in Taiwan may cover three aspects: water quality, water quantity and hydropattern.

### (1) Water quality

Stream flows during the dry season will become much lower, which will lead to reduction of self-cleaning and pollutants-carrying capacity. As the pollutant concentration increases, safety of irrigation water will be degraded severely as to cause decrease of available water for irrigation. It has been found that, from review of the monitored data, unqualified irrigation water has mainly existed in western Taiwan region where insufficient water sources often occur during dry seasons, especially from January to February (Figure 5). Moreover, man-made water pollutions have further exerted impacts on agricultural water quality. Consequently the water at many intakes and in canals cannot well meet the irrigation water quality standards in dry seasons. Although they may be diluted by using the clean water from other sources, the water pollution problems will be more critical once the severe drought comes.

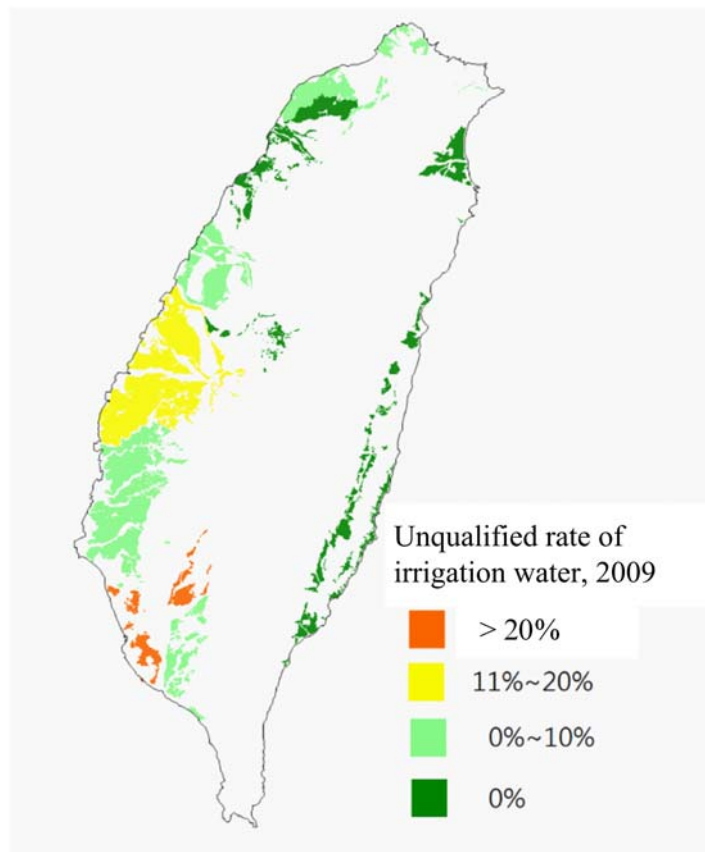

**Figure 5.** Unqualified rate of irrigation water in Taiwan, 2009

(Analyzed by Water Resources Management and Policy Research Center, Taiwan)

## (2) Water quantity

Taiwan has experienced a temperature increment of 0.8°C over the past century. It is noticeable that the annual average temperature has increased for the last 8 consecutive years, which was 0.1°C higher than the global averaged increment of temperature (CWB, R.O.C, 2009). The paddy rice may thus grow faster and shorten its total growth period, but as the solar radiation increases the average total evapotranspiration (ET) for each rice-crop period is estimated to rise by 2.1% and 6.8% within the future 30 and 60 years, respectively (Chen *et. al.*, 2007). According to the Central Weather Bureau, R.O.C (1994), over the past 100 years the rainfalls in the major rice production areas in Taiwan, notably in the southern region, has decreased by 10 to 34 mm every ten years. This phenomenon suggests that, if the current rice-growing area is to be sustained, the irrigation water supply will be further increased.

## (3) Hydropattern

The increase of temperature due to climate change will lead to acceleration of hydrologic cycles, which will cause more uneven temporal and spatial distributions of rainfalls. In consequence, higher intensity rainfalls and more frequent severe droughts will occur. Over the past century, besides the rising temperature phenomenon, the humidity and rainfall have gradually decreased and extreme weather intensities have become more severe across Taiwan (CWB, R.O.C, 2009). These changes have induced alteration of inflow patterns to and reduction of capacities of the reservoirs in Taiwan, which has made the IAs depending on reservoir water supply more difficult to carry out existing irrigation requirement schemes (Figure 4). Meanwhile, in the last 100 years the typhoons striking Taiwan were also more frequent, increasing by 0.1 - 0.3 occurrence every ten years (CWB, R.O.C, 2009). Moreover, the rainfall intensities and amounts induced by these typhoons were also increasing. For instance, when Typhoon Morakot hit Taiwan in 2009, the cumulative rainfalls in the southern region reached 2,800 mm in only two days. The heavy rainfalls led to a loss of around NT\$ 1.502 billion in total, in addition to the triggering of severe land sliding as well as erosion of hilly slopes that eventually caused heavy siltation in the southern Zengwen Reservoir, the largest reservoir in Taiwan. The total volume of siltation in the reservoir exceeded 90 million cu. m, which reduced the reservoir capacity by one sixth, and thus adversely influenced the supplements to agricultural water use (statistics from WRA, MOEA).

The extreme weather also causes higher frequencies of drought events which often lead to water shortages of domestic and industrial

water supply, and hence needs of shifts of agricultural water to supplement the deficits of those demands. For instance, the irrigation was ever stopped in order to shift its water to supplement the domestic and industrial water demands in five years between 2002 and 2010 (statistics from the COA). Statistics of drought events occurring from 1982 to 2009 provided by the IAs revealed that during the past 10 years, the numbers of years that rice crop suffered from droughts and water shortages were 4 as compared to 2.9 during 1992 ~ 2001. Consequently, those IAs that depend on run-of-river sources have been facing mounting difficulties in drawing water for irrigation due to worsening erratic river flows.

## II. Adaptation strategies for agricultural water in various countries for coping with climate change

Climate change has influenced countries across the world. Regardless of their differences in geographic conditions and or industrial situations, they have formulated adaptation strategies to cope with their agricultural water resources problems. These strategies may be categorized in the following six directions: (1) investment in irrigation infrastructure, (2) upgrading of water resource utilization systems, (3) development of water-save technologies, (4) strengthening of early warning and countermeasure systems, (5) adjustment of farming patterns, and (6) improvement of crop varieties (Table 1).

**Table 1.** Categories of contemporary national adaptation strategies for agricultural water resources in the world

Strategy	Program
Investment in irrigation infrastructure	<ul style="list-style-type: none"> <li>●Improvement of irrigation infrastructure through judicious development and optimized layout of water resources. (China)</li> <li>●Effective utilization of existing irrigation facilities to ensure the essential water supply capacities. (Japan)</li> <li>●Upgrading of the management and maintenance of existing water resources supply systems, and building of dams for irrigation. (NAPAs)</li> <li>●Promotion of construction of farm ponds and other water storage facilities. (India)</li> </ul>
Complement to the water resource	<ul style="list-style-type: none"> <li>●Redistribution of water rights. (Japan)</li> <li>●Strict management and adjustment of existing water uses in the event of abnormal water shortage.. (Japan)</li> <li>●Saving of 10% to 15% irrigation water quantities by pricing the irrigation water. (Israel)</li> </ul>

application system.	<ul style="list-style-type: none"> <li>● Distribution of water resources in equitable amounts during droughts. (United Kingdom)</li> <li>● Stipulation of the methods for levying the charges of agricultural water resources and discharge of waste water into irrigation canals. (Germany)</li> <li>● Establishment of mechanism for allocation of and compensation to the agricultural water shifted to industrial use during droughts. (Germany)</li> <li>● Stipulation of specifications and policies for management of water rights. (Germany)</li> <li>● Scheduling of national water saving periods, and with authority's stipulations that all irrigation water use quantities should meet government' criteria; such as in certain areas are only permitted to be irrigated at night during the designated period. (France)</li> </ul>
Strengthening of the early warning and response system	<ul style="list-style-type: none"> <li>● Conduction of long-term research of and assistance to decision makers in identification &amp; clarification of the impacts of climate change on agriculture and industries, and ratios of impacts &amp; uncertainty. (United Kingdom)</li> <li>● Assessment of the damage in agricultural sector in terms of monetary values. (United Kingdom)</li> <li>● Identification of high-risk areas of water shortage by means of assessment of their vulnerability, and then execution/ improvement of adaptation strategies. (Japan)</li> <li>● Assessment of the vulnerability of regions as well as agriculture and impact of extreme climate on agricultural production, thereby effectively integrating related factors including climate change impact, risk management, water resources and irrigation facilities for development of tools for decision-making. (Australia)</li> <li>● Implementation of monitoring programs for water quality and quantity, and comprehensively planning of management system for agricultural water uses. (NAPAs)</li> <li>● Defining the priorities of various adaptation programs and integrating the models for irrigation and agriculture, to accommodate the anticipated impacts of climate change on water resources and irrigation water. (UNPD)</li> </ul>
Development of water-save technology	<ul style="list-style-type: none"> <li>● Promotion of water-save measures in northern and northwestern regions of China. (China)</li> <li>● Extension of the ration of water saving and automatic irrigation system facilities to a total of 90%. (Israel)</li> </ul>
Improvement	<ul style="list-style-type: none"> <li>● Selection and cultivation of drought-tolerant crop varieties.</li> </ul>

of crop varieties	<p>(China)</p> <ul style="list-style-type: none"> <li>● Improvement of crop cultivation techniques. (Japan)</li> <li>● In coping with poor harvests of cereal grains caused by high temperature and drought in summer, agricultural departments to formulate measures for adjustment of farming patterns to relieve agricultural damage and loss and hence to enhance food security. (Spain)</li> <li>● Implementation of crop diversification, including introducing of drought-tolerant crops. (NAPAs)</li> </ul>
Adjustment of farming system	<ul style="list-style-type: none"> <li>● Adjustment of cropping system. (China)</li> <li>● Saving agricultural water uses through changes of crop categories and farm management &amp; operations. (United Kingdom)</li> <li>● Shifting of the crop cultivation areas and control of the environment of husbandry sites. (Japan)</li> <li>● Setup of long-term plans for the farmlands with elevations below sea levels. (the Netherlands)</li> <li>● In the northern Europe (Scandinavia), promotion of the agricultural management improvement projects for adaptation to relatively longer crop growing seasons. (European Union)</li> <li>● Extension of crop rotation area. (European Union)</li> <li>● Adjustment of crop growing and harvest seasons. (UNPD)</li> </ul>

### III. Adaptation strategies for agricultural water resources in Taiwan

To cope with the previously mentioned problems due to climate change in Taiwan, the Council of Agriculture (COA) has issued the following agricultural administration policies in 2009: (1) strengthening of multi-functional irrigation infrastructure, (2) improvement of basic environment for agricultural production, (3) full development of productive, ecologic and living functions of agricultural water resources, (4) building up national Geographic Information System for irrigation, (5) upgrading of irrigation management efficiencies, and (6) full uses of the resources of IAs to develop water resources related industries. In Table 2 are displayed various measures and emphatic adaptation strategies formulated for agricultural water resources.

**Table 2.** Major irrigation works in Taiwan & other countries in relation to agricultural water resources adaptation strategies.

<b>Council of Agriculture (COA), Taiwan</b>	<b>Other Countries</b>
I. Renovation & improvement of old irrigation canals and facilities.	● Investment in irrigation infrastructure.
II. Conducting integrated planning of farmland consolidation projects by taking into account local industrial cultural, ecological and living environments.	● Investment in irrigation infrastructure.
III. Renovation & improvement of irrigation canals and farm drains in previous farmland consolidated areas..	● Investment in irrigation infrastructure.
IV. Promotion of ecology-based & safety-oriented irrigation infrastructure.	● Investment in irrigation infrastructure.
V. Promotion of upland crop irrigation and modernization of its management, and support & guidance to the farmers for constructing pipeline systems for upland crop irrigation.	● Develop agricultural water saving technology.
VI. Introducing of Geographic Information System, Internet and other electronic-related technologies for application to irrigation management system.	● Improvement of water resource application system.
VII. Protection of natural paddy environment and improvement of irrigation management system, to increase paddy field's functions of groundwater recharge, water retention, and flood mitigation.	<ul style="list-style-type: none"> <li>● Strengthening of water resources utilization system.</li> <li>● Augmentation of early warning and response system.</li> </ul>

---

VIII. Monitoring of water quality in irrigation canals & drains to ensure water quality.	● Augmentation of early warning and response system.
--	--

---

#### **IV. Recommended adaptation strategies, direction and implementation approach for Taiwan's agriculture**

##### **Strategy 1. Strengthening of water-saving measures for agriculture to increase water use efficiencies.**

Direction:

- (1) To maintain agricultural water quality, quantity and facilities.
- (2) To formulate adequate water-saving measures for irrigation.
- (3) To promote agricultural water use efficiencies.

Concrete implementation approach:

- a. To set policies and guidelines for agricultural water resources in coping with climate change.
- b. To strengthen water quantity observation and quality monitoring management, and actively research and develop effective early warning system.
- c. To restrict discharging of drainage water into irrigation canals, and gradually implement separation of irrigation systems from drainage systems.
- d. To enhance renewal and improvement of major water drawal and conveyance and distribution works.
- e. To implement comprehensive farmland consolidation projects, and increase investment in irrigation water allocation as well as storage facilities.
- f. To continually promote water-save irrigation measures.
- g. To continually extend the water-save pipeline irrigation for upland crops.
- h. To fortify research and development of the drought-tolerant and high-yield crop varieties.
- i. To assess comprehensively the potential of agricultural water resources and set up flexible farming systems in various areas.



## **Strategy 2. Establishment of flexible agricultural water-use system.**

Direction:

- (1) To manage agricultural water uses to adapt to extreme weather conditions.
- (2) To vitalize the proper use and economic utilization of agricultural water.
- (3) To establish funds for shifting of agricultural water to other purposes.

Concrete implementation approach:

- a. To set up water supply mechanism for vitalizing agricultural water resources.
- b. To study the adjustment of farming systems in the areas with menace of high-risk water deficiency.
- c. To develop irrigation management technologies for integrated uses of subsurface and surface water.
- d. To recommend to the Executive Yuan (Cabinet) on establishment of the Fund for Implementation of Shift of Agricultural Water to Other Purposes”.

## **Strategy 3. Storing water and recharging groundwater with the water retended in paddy fields.**

Direction:

- (1) To utilize wisely the paddy field’s tri-functions of production, ecology and living to relieve the climate change impacts.
- (2) To fully develop the paddy field’s water storage and flood retention functions to minimize the damage caused by typhoons and floods.
- (3) To recharge groundwater through paddy fields so as to store water in/beneath farms.

Detailed implementation approach:

- a. To speed up establishment of mechanism for evaluation of the multi-functions of the rice agriculture.
- b. To augment the productive, ecologic and living functions of paddy fields to mitigate the impacts of climate change.
- c. To extend the education and propagation to the farmers on topics of the tri-functions of paddy fields (production,

ecology and living).

- d. To promote the setup of demonstration plots for groundwater recharge through and flood retention in paddy fields, and then extend gradually the area of such practice.

**Strategy 4. Review and strengthening of the operation and management of agricultural water resources to support the early warning system of droughts and floods**

Direction:

- (1) To reform and renovate the existing irrigation facilities.
- (2) To review and augment the water resources management strategies.
- (3) To take appropriate countermeasures for the damage of water intake works in the wake of floods.

Detailed implementation approach:

- a. To comprehensively review the early warning and countermeasure systems for droughts and floods, by taking into consideration the impacts of climate change.
- b. To comprehensively study the fragility of agriculture water resources and associated facilities under impacts of climate change, and on the effective arrangement of investments in irrigation-related industries.
- c. To formulate measures for post-disaster reconstruction of irrigation facilities and related financial support mechanisms.

### **Summaries and Conclusions**

The recommended adaptation strategies for Taiwan's agriculture are as follow: strengthening of water-saving measures, establishment of flexible agricultural water-use system, use paddy fields as retention pools, review and strengthening the operation and management of agricultural water resources.

### **References**

- FAO, 2002. World Agriculture: Towards 2015/2030 Summary Report, Food and Agriculture Organization of the United Nations.
- Hua Xie and J. Wayland Eheart, 2004. Effects of Climate Change on Irrigation Decisions and Low Flow Frequency for a Typical Agricultural River Basin of

- the Midwestern US, World Water and Environmental Resources Congress 2004.
- IFPRI, 2009. Climate Change: Impact On Agriculture and Costs Of Adaptation, International Food Policy Research Institute.
- IPCC, 2007. IPCC Fourth Assessment Report: Climate Change 2007 (AR4), Intergovernmental Panel on Climate Change.
- UNEP, 2002. UNEP in 2002 : Environment for Development, United Nations Environmental Program.
- Central Weather Bureau,1994. Analysis and Assessment of Climate Change in Taiwan. (in Chinese)
- Central Weather Bureau, 2009. 1897-2008 Statistics of Climate Change in Taiwan. (in Chinese)
- Qin, D. 2002. China's National Assessment Report on Climate Change, Science Press. (in Chinese)
- Department of Bioenvironmental Systems Engineering, National Taiwan University. 2004. The Climate Change Impacts on Hydrology and Water Resources Management and Adaptation Strategies. (in Chinese)
- Chen, S. H., Chen G. H., Huang J. T., Yao, M. H., Lee P. H. and Shen, Y, 2007. Effects of Global Warming to Rice Production in Taiwan, Agronomy Society of Taiwan. (in Chinese)
- Water Resources Management and Policy Research Center, Tamkang University, Taiwan, 2008. Improving capability for water resource affairs management and policy-planning, Water Resources Agency, Ministry of Economic Affairs. (in Chinese)
- Ministry of Land, Infrastructure, Transport and Tourism, 2008. Water Resources in Japan. (in Japanese)
- Water Resources Agency, Ministry of Economic Affairs, 2005. Introduction to the Water Resources Agency, Ministry of Economic Affairs. (in Chinese)
- Council for Economic Planning and Development, 2008. Assessment of Long-term Effects of Climate Change and Adaptation Strategies, General Report I. (in Chinese)



## 附 錄 四

### 第 6 屆亞洲區域研討會論文發表

利用 Vensim 模式估算區域性水稻灌溉系統之供水量

The Estimation of Water Supply of Regional Paddy Irrigation System by  
Vensim Model

Hao-Lieh Huang, Ray-Shyan Wu

(黃浩烈、吳瑞賢)



# THE ESTIMATION OF WATER SUPPLY OF REGIONAL PADDY IRRIGATION SYSTEM BY VENSIM MODEL

Hao-Lieh Huang<sup>1</sup> Ray-Shyan Wu<sup>2</sup>

## ABSTRACT

This research investigated into the influence of irrigation water requirement with the irrigation operation including channel supply, wire supply and pond supply. Taoyuan Channel #2 Feeder in North Taiwan was selected as the study area. The agriculture irrigation system model was established by adapting Vensim model and the irrigation water supply data in 2008 was applied.

The simulation result showed that outflow occurred with two main parameters: rainfall, when rainfall is big enough, outflow can be happen; otherwise is paddy ridge changed. The rate of outflow in second crop is higher than that in first crop. The rainfall is hard to store in fields due to typhoon or torrential rainfall and usually happened in second crop. Adding the pond irrigation system into the agricultural irrigation system can afford more water for paddy field and be an importance role at water shortage stage which has no rainfall. The pond irrigation system improved stable irrigation and saving the water from rainfall for irrigation.

## INTRODUCTION AND BACKGROUND

The water balance equation is used to simulate water demand during crop growing period. According to crop characteristic, environment of study area and local weather data, and matching different irrigation management, irrigation system was established. Tsai (2009) selected Taoyuan Channel #2 Feeder as the study area, and established agriculture irrigation system model by Vensim model with irrigation water supply data in 2008 applied. The results revealed outflow occurred due to two main factors, one is the excess rainfall that paddy field can't store, the other is paddy ridge, decreasing height of paddy ridge made water outflow. Lin (2010) selected Taoyuan Channel #2 Feeder as the study area, and established pond irrigation system into the model by Vensim model. The result shows that closing pond irrigation system adversely affected on growing of the crops. And the water shortage occurred with the centralization rainfall pattern in second crop under the condition of closing ponds.

## CONCEPTS OF AGEICULTURE IRRIGATION SYSTEM

The water requirement of a crop is signified by the amount of water needed to growth and it includes water to meet both consumptive and special needs, such as land preparation, land submergence, leaching and so on. The irrigation associations

---

<sup>1</sup> PhD student; Dept. of Civil Engineering, National Central University; No.300, Jhongda Rd., Jhongli City, Taoyuan County 32001, Taiwan

<sup>2</sup> Professor; Dept. of Civil Engineering, National Central University; No.300, Jhongda Rd., Jhongli City, Taoyuan County 32001, Taiwan; raywu@ncu.edu.tw

always estimated the water demand that assumed all fields belonged to paddy field in its land.

As shown in Fig. 1, when rain water falls on fields, the irrigation water flows into fields from irrigation channel. The rainfall plus irrigation water needs to satisfy water demand. The water demand included crop evapotranspiration, outflow and leakage. The leakage is recharged groundwater. Sometimes outflow can be reused by downstream fields and others are drained to sea.

### PADDY RICE IRRIGATION SYSTEM MODEL

#### Water equilibration principle

According to the water equilibration principle of the hydrologic cycle, calculated water output subtracted from water input, which is equivalent to the changing volume of water storage. This common water equilibration formula for ground water and the underground water system is described in further detail below:

$$I - O = \frac{dS_f}{dt} \quad (1)$$

Where  $I$  is the inflow,  $O$  is the outflow,  $S_f$  is the field storage, and  $t$  is time.

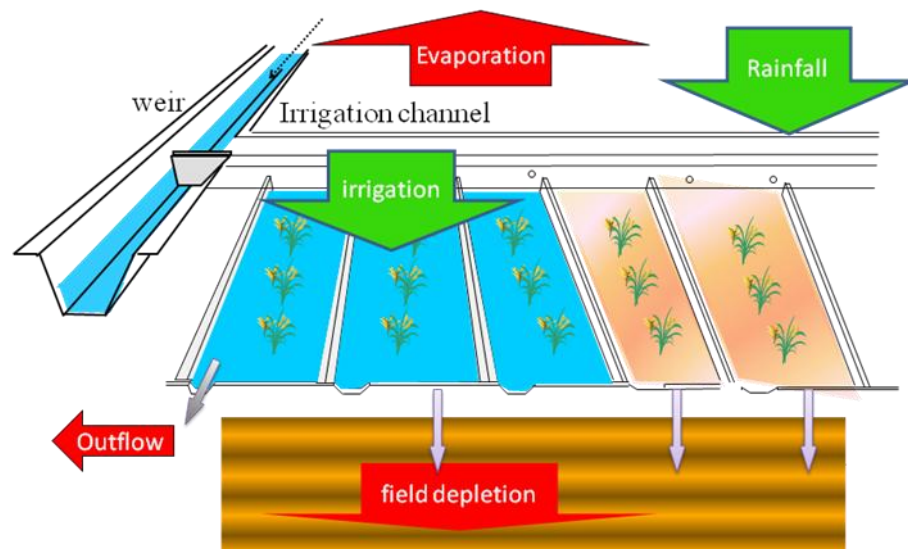

**Figure 1.** The hydrologic components for crop fields

Analysis of the mechanisms of the paddy field water equilibration in this study, e.g., rainfall, evapotranspiration, irrigation routing water, etc., excluding the study of soil water content, used the paddy field as control volume (Fig. 2). The formula for water equilibration for a specified period is shown below:

$$S_i = S_{i-1} + IR_i + IO_i + W_i + P_i - ET_i + F_i - DR_i \quad (2)$$

Where  $S$  is field storage,  $IR$  is irrigation inflow,  $IO$  is return flow from upstream,  $P$  is rainfall water,  $ET$  is evapotranspiration,  $W$  is weir irrigation water,  $F$  is field depletion,  $DR$  is field outflow, and  $i$  is a specified period of time. The irrigation water



resource included weir and Taoyuan Channel #2 Feeder.

$$\text{if } S_i \geq H_i, \text{ then } DR_i = S_i - H_i \quad (3)$$

$$\text{if } S_i < H_i, \text{ then } DR_i = 0$$

When the field storage (  $S$  ) water reserves exceeds the water exiting field ridges (  $H$  ), a field return flow volume (  $DR > 0$  ) is observed; no outflow (  $DR = 0$  ) is observed when vice versa. The paddy field ridges refers to Kan (1996) presented the optimal water depth in grow stages for Taiwan paddy rice. The vegetable has bad water resistance therefore it is assumed that the height of paddy ridge is 0 in vegetable field in model.

In this study, the field storage is the sum of the height of pond water (  $h'$  ) plus the height of field capacity (  $h''$  ), and soil depth is assumed to be 30 cm. The soil has its field capacity as shown in Tab. 1 (Wang & Yi, 1979).

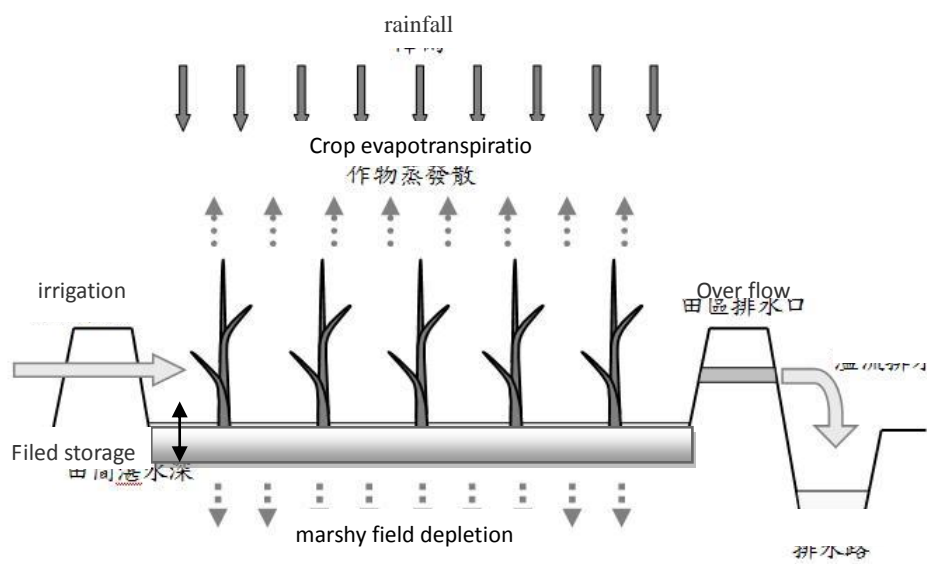

**Figure 2.** Paddy field water balance model

**Table 1.** The estimation of soil moisture capacity in different soil

Soil type	Percentage of dried soil	
	Field capacity	Wilting point
clay	36	20
Clay loam	24	15
sandy clay loam	19	10
sandy loam	12	5

### Estimation of Evapotranspiration

The crop water requirement can be decided by direct measurement or through indirect calculation. Although direct measurement can obtain an actual water requirement, it costs more money and labor due to morphological constraints. Instead, the indirect calculation is usually used by researches. The calculation equation is expressed as below:

$$ET_{CORP} = K_c \times ET_0 \quad (4)$$

$$ET_0 = K_p \times ET \quad (5)$$

Where  $ET_{crop}$  is the crop water requirement,  $K_c$  is the dimensionless crop coefficient which varies with season, approximately 0.6~1.5 (first crop) and 0.5~1.7 (second crop) for paddy rice. The  $ET_0$  refers to the reference evapotranspiration of standard crop canopy, which is pan coefficient ( $K_p$ ) multiplied by evaporation ( $ET$ ). The evaporation used history evaporation data which is measured by pan evaporation. According to the growing seasons of all crops (paddy rice) (Masakazu, 1999; Chang et al., 2001), one can determine the total crop water requirement for any period.

#### Estimation of field depletion

The estimation of field depletion used experience equation in designing specification which is built by Water Resources Agency, Ministry of Economic Affairs. The experience equation is shown below:

$$P = \frac{240}{s \cdot l} \quad (6)$$

Where  $P$  is the field depletion,  $s$  is the percentage of clay weight, which is under 0.005mm and  $l$  is leakage coefficient of soil. Consequently, estimation of field depletion on different soils can be calculated, according to soil type data in irrigation associations and result of field experiment which is proceed by Water Resources Agency, Ministry of Economic Affairs as Tab. 2(Kan,1979). In this study, the field depletion in model is ascertained that it is decided by field capacity as shown below:

$$\text{If } S > FC \quad \text{then } DF = \min(P, S - FC) \quad (7)$$

$$\text{If } S < FC \quad \text{then } DF = 0$$

$$FC = \text{Soil depth} \times \text{Percentage of Field Capacity}$$

Where  $P$  is the field depletion (mm/day) and  $FC$  is field capacity. The soil types are clay, Clay loam, sandy clay loam and sandy loam with the study area of Taoyuan

Channel #2 Feeder.

**Table 2.** The estimation of field depletion on different soil

Soil type	Clay content ( S )	coefficient ( I )	field depletion ( mm/day )
sandy loam	14.9	1.4	11.5
Clay loam	21.9	1.6	6.85
clay	33	1.8	4.04

### STUDY AREA SYSTEM

In this study, the model estimated by System Dynamics that Prof. Jay W. Forrester and developed in 1960. The System Dynamics included information theory, systematic theory, control theory, decision theory and computer simulation, etc. It had a main purpose to show behavior of system dynamics changed by time. Although it not only had forecast function, but also can reveal relationship of dynamic between system and time. This study established water balance equation by Vinsim model to calculated outflow, crop evapotranspiration and simulated water supply procedure of weir. The model was built up as Fig 3.

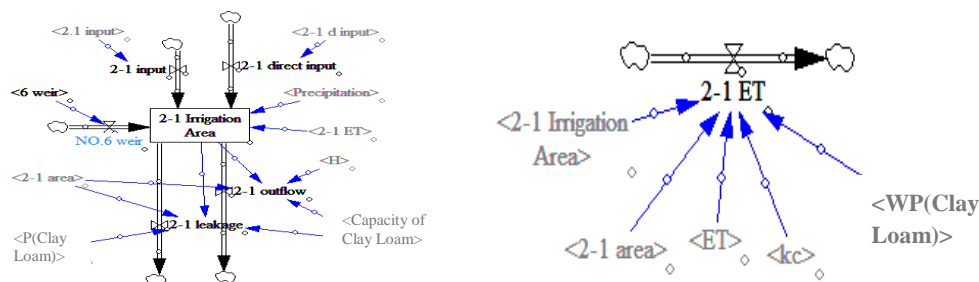

**Figure 3.** The estimation system of outflow and crop evapotranspiration

### Study Area Description

The study area is the second of 15 feeders in Taoyuan main canal, with a size of 2,765 ha, belongs to the Taoyuan Irrigation Association. There are 38 irrigation areas and geographic positions shown in Fig 4. The study area lies in subtropical climate. The wet season is from May to September, with dry season from October to April. Although the mean annual rainfall is 2658 mm in Taoyuan area, about 61.9% is concentrated in the wet season, it showed that the distribution of rainfall is very uneven. The first season paddy rice begins in late February and ends in mid-July, while the second season paddy rice begins in early June and ends in early November.

The soil types included clay , clay loam, sandy loam and sandy clay loam in irrigation site of Taoyuan Irrigation Association. The percentage of soil component in the study area are as following : rate of clay loam is 33.99%, rate of sandy loam is 28.55%, rate of clay is 19.72% and sandy clay loam is 17.75%. The soil types and area in irrigation sites are shown in Tab. 3.

### **Irrigation resource**

The surface irrigation water in Taoyuan Channel #2 Feeder came from reservoirs and rivers. In this study, the reservoir irrigation water data with ten days as the cultivation period is provided by Taoyuan Irrigation Association. The supply water input is from feeder (i.e. the real consumed water in field) and model is assumed to have no water conveyance loss. For the river irrigation water, there are 16 river weirs in this irrigation model, and the water right for each weir is collected and collated by Taoyuan Irrigation Association.

Tao-Yuan pond irrigation system is the ancestor's intention to increase the effective rainfall to overcome the particular climate pattern with the use of geographic advantage. Ponds are not all used to be agricultural irrigation now, some ponds are used to fish culture, disuse or etc... In this study, all ponds assumed to useable and providing irrigation water to paddy field. The pond data shows by Tab. 4.

### **Flow direction of outflow**

The flow direction of outflow in Irrigation site of the second feeder is according to flow direction in irrigation system of Da Ju work station, which is provided by Taoyuan Irrigation Association to decided irrigation section and flow direction in irrigation site.

In general, rainfall can be stored in paddy field when it the quantity is small and paddy ridge had good height, the outflow does not occur. If the quantity of rainfall is too big to produce pond water depth which is higher than height of paddy ridge, the water will overflow into the neighboring fields. The flow direction of outflow was decided by elevation of irrigation site as Fig. 5.

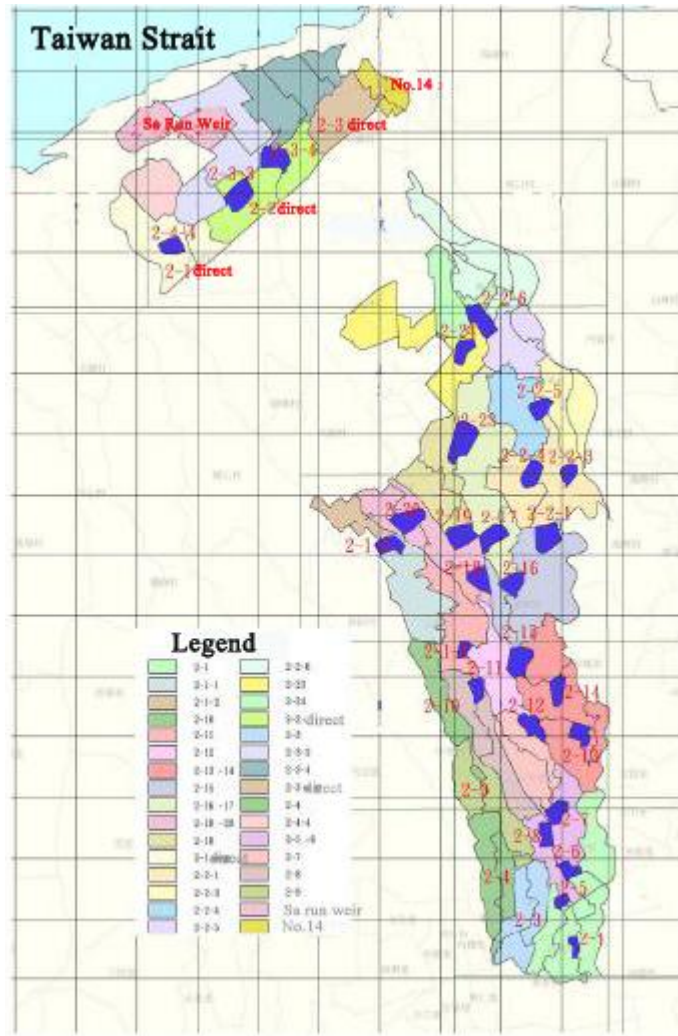

Figure 4. Distribution of Irrigation site of the second feeder

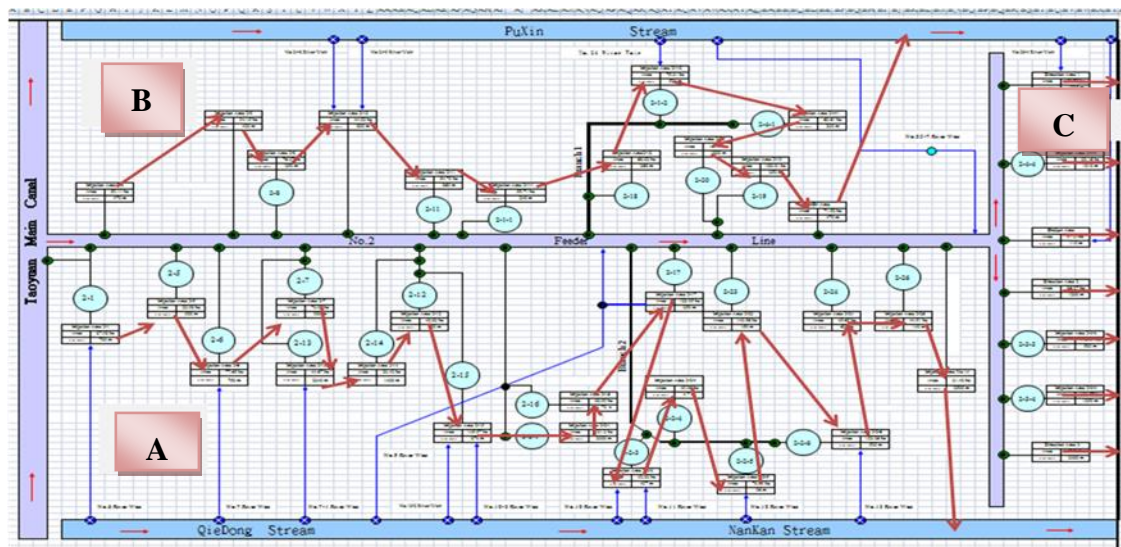

Figure 5. The flow direction of outflow (as arrow)

Table 3. The soil types and area in Irrigation site of the second feeder

Irrigation site	Soil type	Area ( ha )	Irrigation site	Soil type	Area ( ha )
2-1	Clay loam	87.98	2-1-1	Clay loam	55.71
2-3	Clay loam	59.11	2-1-2	Clay loam	75.31
2-5	Clay loam	22.98	2-2-1	Clay loam	131.3
2-6	Clay loam	77.65	2-2-3	Clay loam	27.47
2-7	Clay loam	73.99		sandy clay loam	14.56
2-8	Clay loam	76.37	2-2-4	Clay loam	49.96
2-9	Clay loam	94.15	2-2-5	Clay loam	70.99
2-10	Clay loam	44.22	2-2-6	sandy clay loam	104.00
2-11	Clay loam	54.79		clay	18.26
2-12	Clay loam	40.83	2-3-3	loamy sand	118.07
2-13	Clay loam	44.67	2-3-4	loamy sand	133.57
2-14	Clay loam	23.42	2-4-1	Clay loam	63.61
2-15	Clay loam	145.57	2-4-4	loamy sand	30.16
2-16	Clay loam	38.99	San Shi direct	Clay loam	71.53
2-17	Clay loam	120.95	No.14 weir	loamy sand	31.40
2-18	Clay loam	16.11	Sa run weir	loamy sand	57.21
2-19	Clay loam	100.01	2-1 direct	Clay loam	18.19
2-20	Clay loam	68.02		loamy sand	75.56
2-23	clay	143.56	2-2 direct	Clay loam	86.27
2-24	clay	45.65	2-3 direct	Clay loam	42.94
2-26	clay	44.51			

**Table 4.** Ponds in the study area

No.	Maximum Area(m <sup>2</sup> )	Maximum water level(m)	Maximum Storage(m <sup>3</sup> )
2-1	30,267	2.9	26,294
2-5	32,899	1.8	24,812
2-6	49,340	2.4	60,485
2-7	66,585	3.3	163,634
2-8	34,155	3.0	47,549
2-11	64,940	3.3	115,476
2-12	13,320	1.8	67,512
2-13	58,510	3.2	147,971
2-14	62,171	3.8	131,605
2-15	108,610	3.8	268,065

2-1-1	30,950	2.1	53,079
2-16	68,838	3.6	119,372
2-17	83,267	3.6	161,780
2-2-1	99,600	3.8	211,095
2-2-3	55,436	3.0	108,973
2-2-4	69,134	3.6	139,067
2-2-5	78,770	3.8	232,578
2-18	93,395	4.0	278,682
2-19	140,515	3.1	222,057
2-20	112,496	3.3	235,031
2-1-2	85,389	3.6	155,988
2-4-1	63,956	3.0	111,649
2-23	138,053	4.2	340,683
2-24	59,360	3.3	114,088
2-26	59,336	4.8	102,427
2-2-6	98,560	2.9	137,405
2-3-3	152,927	2.8	233,364
2-3-4	123,440	3.3	285,886
2-4-4	83,920	3.3	202,035

The Fig. 5 showed that Taoyuan Channel #2 Feeder divided irrigation section into 3 parts: A section, B section and C section. In A section, the flow direction of outflow is : 2-1→2-5→2-6 →2-7→2-13→2-14→2-12→2-15→2-2-1→2-16 →2-17 →2-2-3 →2-2-4 →2-2-5 →2-23 →2-24 →2-2-6 →2-26 →No.14 weir. In B section, the flow direction of outflow is :2-3 →2-9 →2-8 →2-10 →2-11 →2-1-1 →2-18 →2-1-2 →2-4-1 →2-20 →2-19 →San Shi direct ; In C section, the outflow flows to river directly.

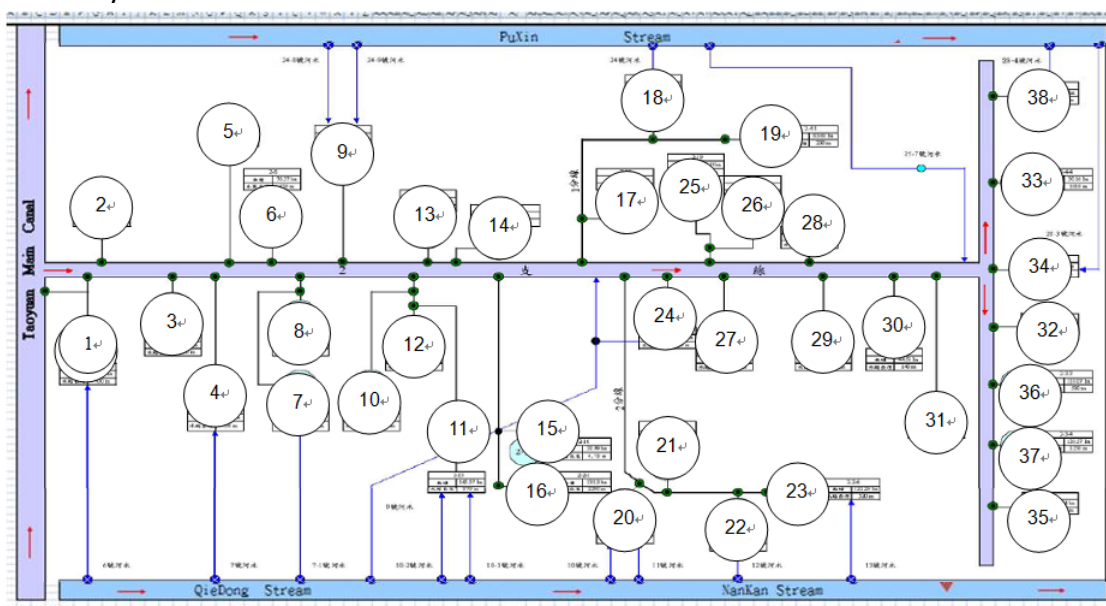

**Figure 6.** The priority order of irrigation

The pond irrigation system works by different elevation and transporting the water from high elevation to low elevation. Considering the elevation, upstream paddy field has higher priority to take irrigation water than downstream paddy field. It is assumed that when pond irrigation system is established into agricultural irrigation system, the flow direction of outflow is same as priority order of irrigation in 38 irrigation sections as Fig. 6.

**Crop and grow period**

The simulation procedure calculates water balance daily in each irrigation area from upstream to downstream. In the simulation, initial depth of pond water is 3 cm. The irrigation water is independent supply except No. 9 weir which shared with many fields and needed to consider the order of taken water.

The analytic time is from March 14<sup>th</sup> 2008 to July 11<sup>th</sup> 2008, totally 120 days for first crop of paddy field, and August 1<sup>st</sup> 2008 to November 28<sup>th</sup> 2008, totally 110 days for second crop of paddy field.

**APPLICATION AND DISCUSSION**

The irrigation water in model used real irrigation data and matched up irrigation style of Taoyuan Irrigation Association. When irrigation source comes from weir and reservoir, the simulation result is shown in Tab. 5. Most of soil type in section C is loamy sand which has more field depletion than section A and section B. And section C has the lowest average pond water depth.

The variation of pond water depth is shown in Fig. 7, and Fig. 8. The pond water depth has never reached the wilting point. In second crop, rainfall is centralized in several times and there is no rainfall at start. Therefore, the pond water depth in Fig. 8 is low and almost reached the wilting point line at start.

The relationship between rainfall and outflow is shown in Fig. 9, and Fig. 10. It showed that outflow occurred very often along with rainfall. As a result of reservoir irrigation and weir irrigation that barely supplies for water demand, irrigation water is not enough to produce outflow. Therefore, when rainfall is too big to produced pond water depth which is higher than the height of paddy ridge, the outflow occurred. The outflow occurred with two main parameters: rainfall, when rainfall is big enough, outflow can be happen; otherwise is paddy ridge changed. The simulation result showed that the rate of outflow in second crop is higher than first crop. The rainfall is hard to store in fields due to typhoon or torrential rainfall and usually happened in second crop.

**Table 5.** The simulation result without pond irrigation system

Section	A		B		C	
Crop	first	second	first	second	first	second
Irrigation(reservoir)	322.5	386.6	276	335.3	0	0
Rainfall	808.5	919	808.5	919	808.5	919
Irrigation(weir)	221.9	202.6	47.9	42.7	1131.5	1041.6



Field depletion	822.3	721.9	812.3	660.7	1593.5	1263.1
Outflow	389.1	637.1	204.4	493.2	328.6	704.9
Crop evapotranspiration	169.3	185.4	169.3	185.4	169.3	185.4
Outflow /Rainfall	0.481	0.693	0.253	0.537	0.406	0.767

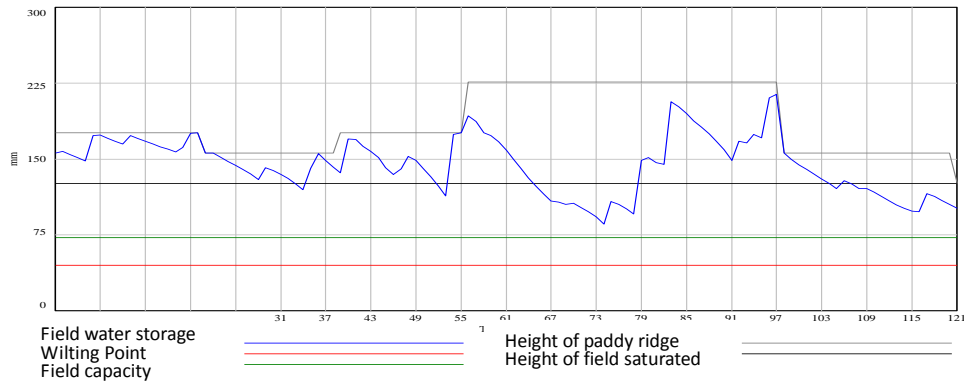

**Figure 7.** The field water depth in section B (first crop)

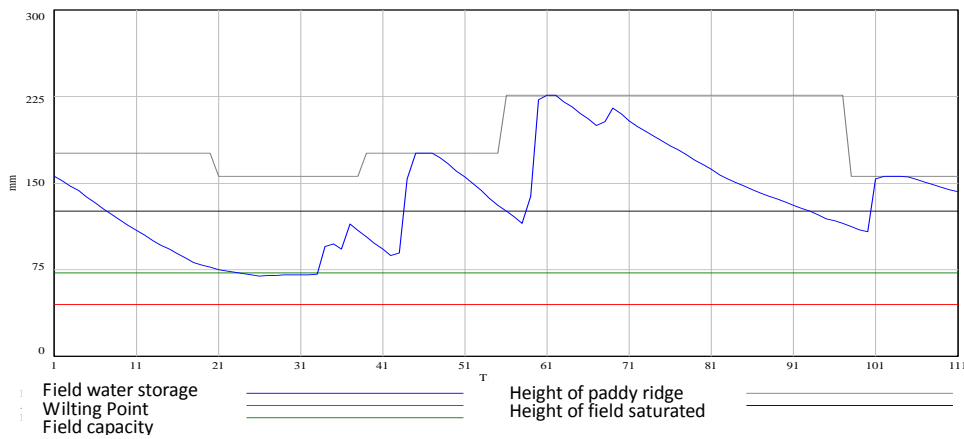

**Figure 8.** The field water depth in section B (second crop)

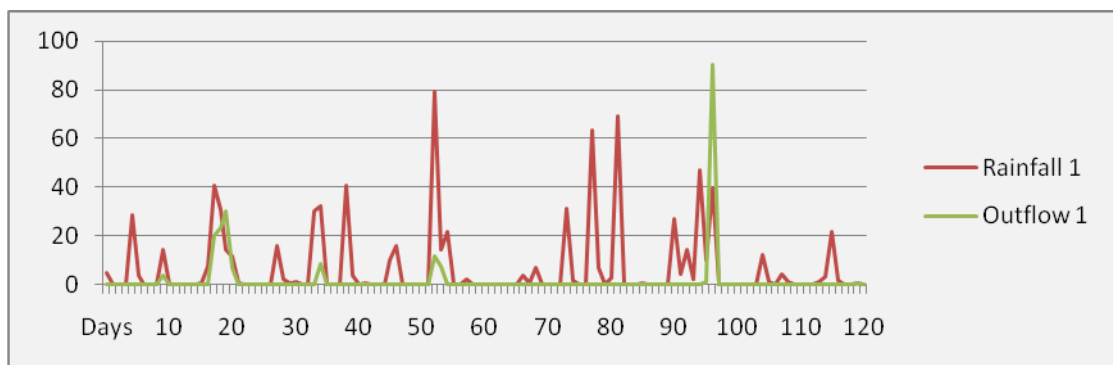

**Figure 9.** The relationship between rainfall and outflow in section B (first crop)

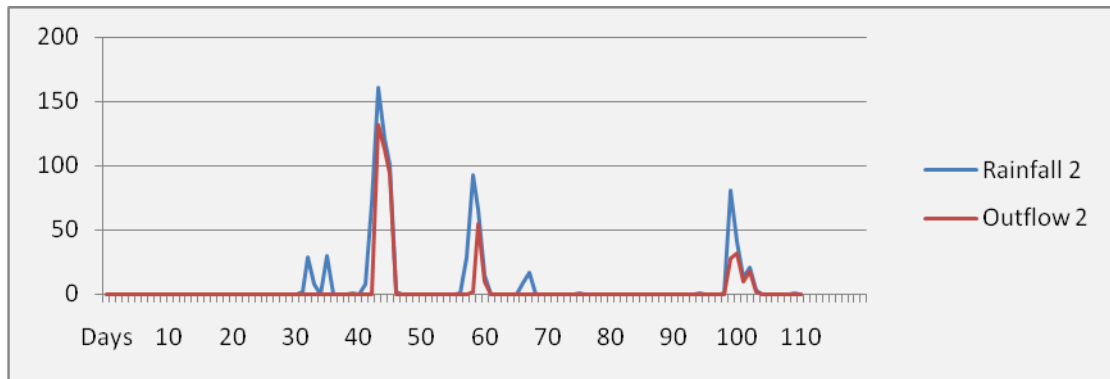

**Figure 10.** The relationship between rainfall and outflow in section B (second crop)

Adding the pond irrigation system into the agricultural irrigation system and the average field water depth is shown as Fig. 11 and Fig. 13. In Fig. 13, the result showed that the pond irrigation afforded more water for paddy field and pond water depth in second crop is decreased more slowly than Fig.8 at beginning stage which has no rainfall.

The variation of water level of pond storage is shown as Fig. 12 and Fig. 14. When reservoir and weir plus the rainfall can afford the water demand, the water level of pond storage is not decreased obvious. In beginning stage of second crop, the water shortage is happened, and pond is needed to transport great quantity water to paddy field. The rainfall can increase the water level of pond storage and saving the water for next irrigation.

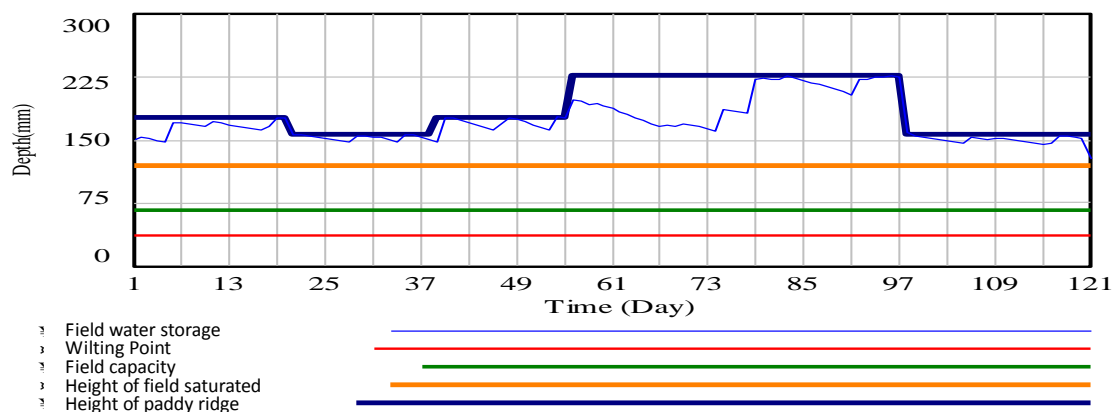

**Figure 11.** The average field water depth with pond irrigation (first crop)

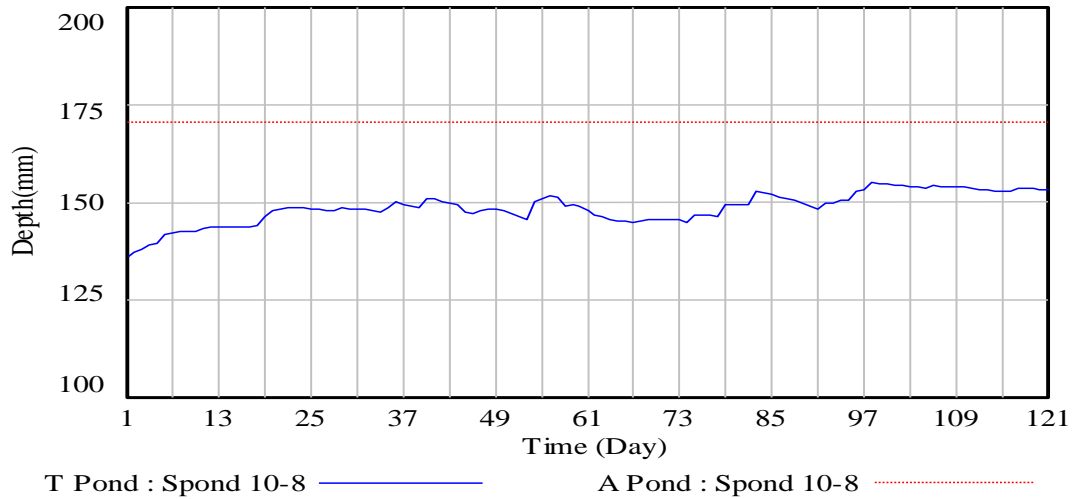

**Figure 12.** The water level of pond storage (first crop)

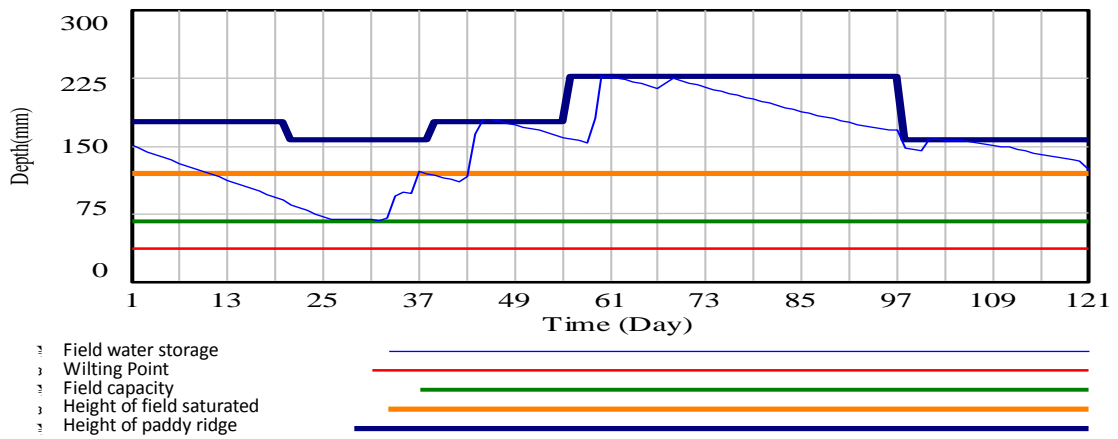

**Figure 13.** The average field water depth with pond irrigation(second crop)

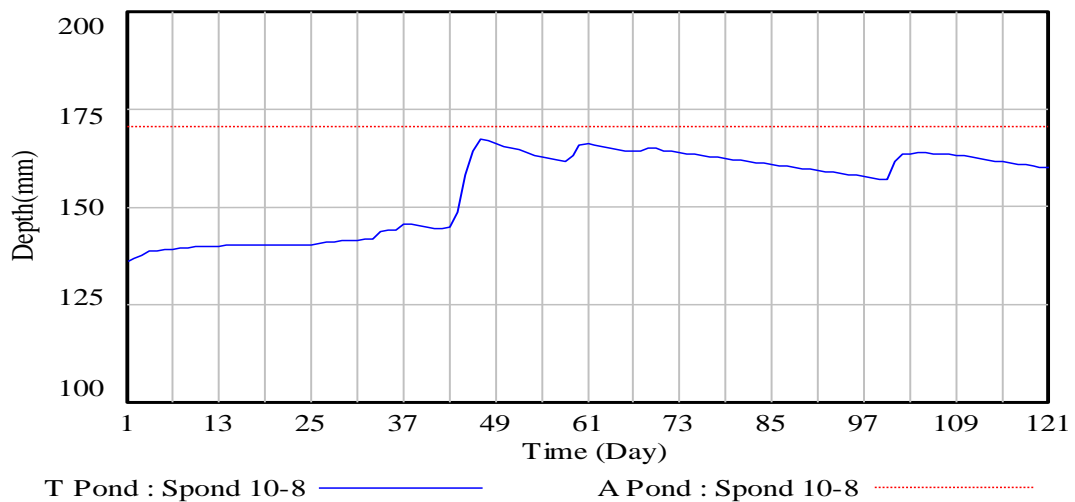

**Figure 14.** The level of pond storage (second crop)

### CONCLUSIONS

This research investigated into the influence of irrigation water requirement

with the irrigation operation including channel supply, wire supply and pond supply. Taoyuan Channel #2 Feeder in North Taiwan was selected as the study area. The agriculture irrigation system model was established by adapting Vensim model and the irrigation water supply data in 2008 was applied.

The simulation result showed that outflow occurred with two main parameters: rainfall, when rainfall is big enough, outflow can be happen; otherwise is paddy ridge changed. The rate of outflow in second crop is higher than that in first crop. The rainfall is hard to store in fields due to typhoon or torrential rainfall and usually happened in second crop. Adding the pond irrigation system into the agricultural irrigation system can afforded more water for paddy field and be an importance role at water shortage stage which has no rainfall. The pond irrigation system improved stable irrigation and saving the water from rainfall for irrigation.

#### REFERENCE

- Chang, Y. C., Kan, C. E., Lin, G. F., Lee, Y. C. and Chiu, C. L., 2001, Potential Benefits of Increased Application of Water to Paddy Fields in Taiwan, *Hydrological Processes*, Vol. 15, No.8, pp. 1515-1524.
- Lin, C. L., 2010, System dynamics modeling for paddy field pond irrigation system, N. C. U. Master D. thesis (in Chinese).
- Tsai, H. Y., 2009, Application of System Dynamics modeling to Estimate Agricultural Irrigation system, N. C. U. Master D. thesis (in Chinese).
- Taoyuan Irrigation Association., 2008, The irrigation study plan in 99 years.
- Kan, C. E., Chen, C. T., and Chen, K. Y., 1996, Study on the Suitability of Consumptive Use Estimation Methods for Taiwan Area, *Journal of Chinese Agricultural Engineering*, Vol. 42, No. 2, pp. 8-19.
- Kan, C. E., 1979, Analysis and study on water supply technology of the agriculture irrigation system, National Taiwan University Agricultural Engineering Department.
- Masakazu, M., 1999, Development of Paddy Field Engineering in Japan, *Advanced Paddy Field Engineering*, Japanese Society of Irrigation, Drainage and Reclamation Engineering, pp. 1-9.
- Wang, R. Y. and Yi, R., 1979, *Applied Hydrology*, Maw Chang Book Co., Ltd.

## 附 錄 五

### 第 6 屆亞洲區域研討會論文發表

曹公圳多功能利用與發展策略之研究

Multifunctional Uses and Development Strategies of Tsao-Gung Canal

Shu-Shr Yeh

(葉世旭)



# Multifunctional Uses and Development Strategies of Tsao-Gung Canal

Shu-shr Yeh <sup>1</sup>

## Abstract

Since the completion of its construction in 1837, the Tsao-Gung Canal (TGC) has irrigated the fertile farmlands located in nowadays metropolitan Kaohsiung area. As time goes by, many of the irrigated farmlands has been transformed into industrial parks and residential areas. As a result the TGC irrigation area has declined from more than 14,000 hectares to about 6,400 hectares and the Canal has been facing the transition of irrigation function.

For pursuing the sustainable management of Tsao-Gung Canal, six professional scholars were engaged in research of the following six aspects of concern:

1. Management and development of agriculture
2. Cultural assets and living in Tsao-Gung irrigation area
3. Contribution of the Tsao-Gung Canal to irrigation engineering and management and its future perspective
4. Irrigation water use transfer by Kaohsiung Farm Irrigation Association (KFIA)
5. Planning and promotion of water-friendly facilities in communities
6. Wetland parks

Afterwards, the canal operators and related people in the KFIA's working stations in Tsao-Gung irrigation area were gathered to explore the problems they practically faced and their solutions based on the research results of the six aspects. Taking "developing agriculture to be an industry with high economic value" as the purpose, they proposed appropriate suggestions on the orientation and direction for future development to the aforementioned working stations. Lastly, the related professionals and scholars and local prominent people were invited to explore the desirable ways for multifunctional uses and the strategies for future development of TGC and to reach consensus on these issues. And it is anticipated that KFIA, local governments, and even central government would scheme the multifunctional uses of Tsao-Gung Canal to accommodate the changing social and environmental situations.

---

<sup>1</sup> Secretary General of Tsao-jiin Memorial Foundation For R & D For Agriculture And Irrigation(Tsao-jiin Foundation) , tsaojiin@ms24.hinet.net Tel:88675885400

<sup>2</sup> The Whole Paper Is On: <http://www.kfia.gov.tw/tjrad/>

## Introduction

The Tsao-Gung Canal (TGC, as Figure 1-1) is located in the Kaohsiung plain in southern Taiwan, spreading in the territories of Kaohsiung County and Kaohsiung City – the second largest city in Taiwan. It was built in the era of China's Qing Dynasty. In order to commemorate the then Fengshan County Magistrate Mr Tsao Jin's merits of initiation of and achievement in construction of the TGC, his superior official, Mr Xong Yi-Ben, named the canal after the magistrate's family name as "Tsao-Gung" (literally Master Tsao) when it was first completed construction in 1839.

The development of irrigation infrastructure in Taiwan was initiated in the era of Koxinga's (Zheng Chenggong) administration of Taiwan Island, who led his army to the island in 1661 and defeated the colonial army of the Dutch administration. During the era of Koxinga's administration the major irrigation facilities in Taiwan were still mainly of small-scale farm ponds and ditches built by farmers themselves. In 1704, the head of Xinglong village (i.e. today's Zuoying area of Kaohsiung City), Mr Song Yong-Qing dredged the local Lotus Lake and also constructed embankments, diversion dams and canals starting from Jiadungkeng to the foot of Banping Hill. This was the first irrigation engineering works proposed and supported by the local authorities. For solving the event of irrigation water shortage in 1837, Magistrate Tsao Jin found that farm ponds could not only retain the surplus water discharged from canals and the rainwater but also regulate the runoffs caused by heavy rainfalls and thus mitigate the floods in the irrigation area itself and nearby. Therefore he adopted canals and farm ponds where appropriate to construct the TGC and diverted the irrigation water from the Xia Danshui River (today's Kaoping River) into it. Originally there were only two main canals: the Old Wuli and the New Wuli for the Tsao-Gung Canal which were completed in 1839, with their headworks located at Jiuqutang of Xiaozhushangli. Moreover, the then Lotus Lake was dredged which made the TGC function more effective. In 1840, an event of severe drought occurred in the Kaohsiung plain area. All the farms except those in the service area of this so-called Tsao-Gung Old Canal suffered from serious disaster. Tsao Jin the Magistrate then constructed the new canal, with its engineering cost refunded by the beneficiaries in accordance with their payment method negotiated and resolved by themselves. Such a method was to levy the land taxes of the benefited farms. This new canal was completed

in 1844, which is the Tsao-Gung New Canal nowadays. Both the old and new canals' water sources were the same, namely the Kaoping River.

Since it was built over 170 years ago, the TGC ever serviced more than 14,000 hectares in the metropolitan Kaohsiung area. This irrigation canal draws water from the Kaoping River at Jiuqutang, and the canal route passes through the metropolitan Kaohsiung area. In Kaohsiung City the Canal ever crossed three major rivers: Houjing, Love and Qianzhen; and connected the then existing large ponds including: 1. Neiwei Pond (now abandoned), 2. Jinshi Lake, 3. Qifan Pond 4. Yangzilin Pond, 5. Benguan Pond (now abandoned), 6. Baozhugou Pond (now abandoned), 7. Amituo Pond (now abandoned), 8. Tianliao Pond (now abandoned), 9. Caigong Pond (now abandoned), 10. Caoya Pond (now abandoned), 11. Popi Lake (now abandoned),



# Kaohsiung Farm Irrigation Association : Tsao-Gung Irrigation System

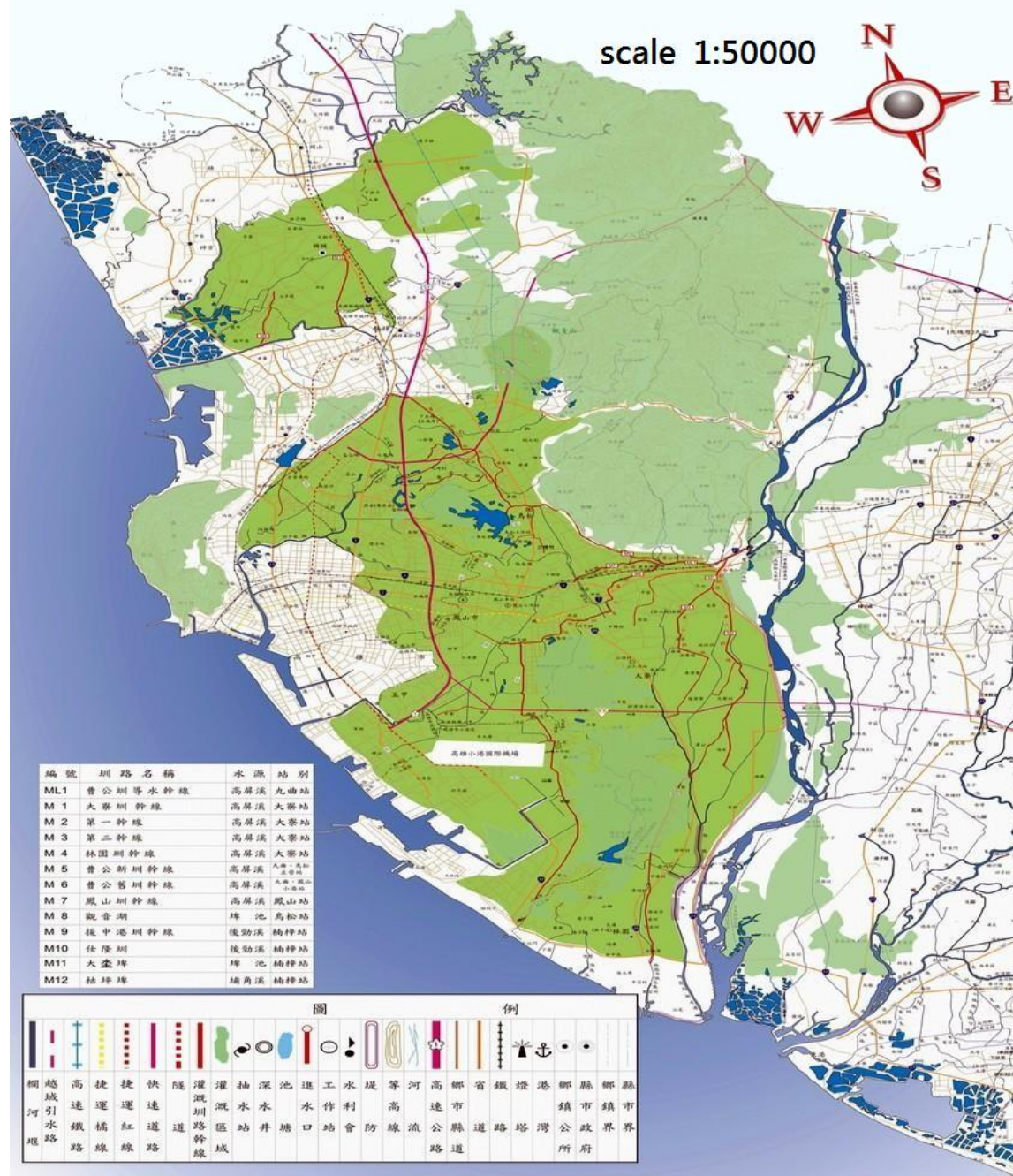

Figure 1-1 Tsao-Gung Irrigation System

12. Caotan Pond (today's Kaohsiung Metropolitan Park), 13. Guanyinhu Pond (discharged into Shilong River and then diverted into the Tsao-Gung irrigation system), and 14. Lotus Lake (the largest of all the ponds). The Tsao-Gung irrigation area spreads in the territories of Kaohsiung County and Kaohsiung City. Its north is bordered by the Gangshan irrigation area and stretches along with the Houjing River into Lingkou, its northeast neighbors with Qishan irrigation area, and its east and southeast are bordered by the Kaoping River. Presently the total irrigation area of TGC reduces to 6,461 hectares, with two rice crop seasons per year plus red beans and muskmelons as the main crops grown in winter. The average annual rainfall is about 1,700 millimeters, but unevenly distributed during the year. The rainy season is from May through September; while the dry season from November to the next April. The study area of this paper is the Tsao-Gung irrigation area serviced by the TGC possessed and managed by KHIA. In the whole area seven working stations have been established by KHIA for irrigation operation and management and maintenance purposes. They are Jiuqu, Daliao, Fongshan, Siaogang, Zuoying, Nanzi, and Niaosong working stations.

### **Six Directions for Research of Multifunction of Tsao-Gung Canal**

In order that the Tsao-Gung Canal functions to support agricultural production, ecology and living (PEL) and to diversify the utilizations of its water resources, in this study was formulated six research directions as described respectively in the following.

#### **Management and Development of Agriculture**

The Tsao-Gung irrigation area of TGC is plentiful with recreational and leisure (R&L) resources and therefore is very suitable for developing R&L agriculture for people to experience its special agricultural products, farm landscapes, rural culture, cultural assets and ecological environments. Additionally, this kind of R&L agriculture will also promote the further growths of related industries such as agriculture, restaurants, home stays, cultural relic souvenir shops and transportation services, among others.

The government at present stage is encouraging the development of domestic R&L tourism agriculture. For example, the national Tourism Bureau has proclaimed the "New Strategy for the Development of Tourism in the 21<sup>st</sup> Century", the Council for Economic Planning and Development has stipulated the "Plan for Promoting the Development of Taiwan's Tourism", and the Council of Agriculture (COA) has formulated the "Regulations for Guidance and Management of Recreational Agriculture". Based on the guidance regulations mentioned above, the recreational agriculture will be able to be further developed.

There are four characteristics in the Tsao-Gung irrigation area in respect of agricultural R&L: (1) the abundance of natural ecological resources; (2) the cultural education related to rural historical relics and ancestral halls; (3) the agricultural resources with respect to the economic crops such as pineapples, longans, water caltrops, rice, sunflowers and white ginger lilies; and (4) waterwheel irrigation systems, hiking, bicycling and crop harvesting. With the incorporation of the

aforementioned R&L activities it is possible that the Tsao-Gung Canal will be able to be developed multi-functionally.

This research was focused on the Tsao-Gung New Canal. Its command area together with the Old Canal’s area in Fongshan City was divided into 5 sub-areas for planning of its R&L districts based on the basin’s upper, middle and lower stream regions. Three tour corridors were laid out; namely, rural ecological corridor (green line), landscape ecological corridor (red line), and historical arts corridor (brown line). Furthermore, five R&L districts were schemed out according to townships, districts and cities. They are: the Water Area of Tsao-Gung (Dashu Township), the Flower Area of Tsao-Gung (Niaosong Township), the Pleasure Area of Tsao-Gung (Renwu Township), the Forest Area of Tsao-Gung (Zuoying District), and the Historicity Area of Tsao-Gung (Fongshan City).

In sum, based on the application of the concept of PEL (agricultural production, ecology and life), the five R&L districts proposed are summarized in Table 2-1:

Table 2-1 Tsao-Gung Canal area development with concepts of agricultural production, ecology and living

PEL Districts	Production	Ecology	Living
Dashu Township	✓	✓	
Niaosong Township	✓	✓	
Renwu Township	✓	✓	✓
Zuoying District		✓	
Fongshan City			✓

### 2-1 .Cultural Assets and Living in Tsao-Gung Irrigation Area

In this research it was tried to investigate and examine the cultural features under the TGC area’s cultures viewed from the veins of its development. Based on the research results, the Tsao-Gung Canal system may be divided into: (1) “district of water source from the Kaoping River” in Meinung and Qishan Townships; (2) “district of water intake of the Tsao-Gung Canal” in Dashu, Daliau and Linyuan Townships; and (3) “Tsao-Gung irrigation district” in Fongshan City, Niaosong Township, and Zuoying and Nanzi Districts. The demarcations of featured cultural districts in the TGC system area are as shown in Figure 2-1.

- (1) The district of water source from the Kaoping River (Meinung and Qishan Townships)

- (2) The district of water intake of Tsao-Gung Canal (Dashu, Daliau and Linyuan Townships)
- (3) Tsao-Gung Canal irrigation district (Fongshan City, Niaosong Township, and Zuoying and Nanzi Districts)

### **2-3. Contribution of the Tsao-Gung Canal to Irrigation Engineering and Management and its Future Perspective**

In response to the social changes such as the drastically decreasing farmlands which has been difficult to proportionally reduce the related irrigation canals, the Tsao-Gung Canal should be, in addition to keeping the existing agricultural irrigation function, studied the feasibility of its multifunctional uses to meet the needs of society and community environments. Therefore the purpose of this study was to review the mutual interference between drainage and floods in the entire water system of Tsao-Gung New Canal, and use of the Monte Carlo's simulation method to understand the flow situations under different canal flow conditions. The conclusions thus obtained are as follows:

1. The Tsao-Gung Canal (TGC) has been used for a long time, but most reports on it have been focused on its history, and part of them were about its irrigation performances, while its drainage and flood-prevention functions remain to be further studied.
2. There is no need to renovate the TGC without taking well prepared plans in advance and at the expense of its history and natural scenery. The problems due to previous inappropriate design of urban drainage should be solved by installation of sewage pipelines and improvement of sewer systems, instead of blaming the Tsao-Gung Canal.
3. The design discharge of the Tsao-Gung New Canal is about 110cms. After review of the statistics and analysis of its uses, it was found that at the times of big floods (once in every 20 years), its cross-sections were insufficient. For dealing with this problem, the KHIA itself should conduct relevant study and analysis to clarify the responsibilities due, and request the water regulation authorities to take into account the design of adequate drainage facilities such that the irrigation function of Tsao-Gung Canal can be sustained.
4. In this research the Monte Carlo's method was applied to practically calculate and analyze the variations of flows. Under the circumstances of lack of data and rather difficulty in control of scenarios, this tool was quite helpful in simulating the possible events that had never happened before, and hence is worthy of being promoted for further application.

### **2-4 . Irrigation Water Use Transfer by Kaohsiung Irrigation Association**

It is increasingly uneasy to develop new water sources in Kaohsiung area nowadays, and the existing water resources have been gradually becoming insufficient to meet the growing demands. Under such conditions, it is essential to regulate and distribute the available limited water resources in the optimum way so

that the good water distribution will be achieved. In this research some suggestions were presented to the Kaohsiung Irrigation Association on save of more irrigation water for being transferred to other use purposes with charges of reasonable compensation for the transferred irrigation water. The suggestions are as follows:

1. In pricing the compensations for transferred water, it is necessary to take into account the additional costs for feedbacks to the costs required for the existing accomplishments of irrigation management techniques and the follow-up acceleration of R&D of new irrigation techniques.
2. To promote the Irrigation Association's management technologies for efficiently raising its capability in digitalized management and fulfilling water-save irrigation as well as rotational irrigation management, so as to increase irrigation efficiencies and hence save irrigation water.
3. To carry out R&D work of new irrigation techniques, step up the experiments and researches of the next generation's new paddy field irrigation techniques, and promote their applications at suitable times when it is economically beneficial.
4. To conduct research of related trading mechanisms of the trade platform of water bank, promote rational water trading markets, and facilitate the rationalization and economization of regulation, distribution and transfer of water.

## **2-5 .Planning and Promotion of Water-friendly Facilities in Communities**

The following suggestions are proposed based on the on-site reconnaissance results at some spots where the Tsao-Gung Canal runs through, if these places are to be built the community water-friendly facilities:

1. Presently the quality of the water source of Tsao-Gung Canal is turbid. So before constructing community water-friendly facilities, the quality of the canal's water source is suggested to be improved first; then the treatments of water quality would be more efficient if certain places in the Canal's middle and down stream reaches are planned for construction of community water-friendly facilities.
2. The water gates of Tsao-Gung Old Canal have been assessed as the humanistic historical relics, and the local residents also suggested that the related competent authorities preserve their original appearances. Such a suggestion if adopted would bring about another business opportunities to local communities.
3. According to the present picture of the Mengli Village of Fongshan City where the downstream reach of Tsao-Gung Canal runs through, although the landscape design of the canal's banks have been primarily laid out it was found that the participation of the local community residents were less enthusiastic; and that the canal bank landscapes were designed with use of vertical earth-walls, and therefore are less water-friendly. Moreover, the water quality is not clean enough and needs be improved.
4. The improvement of Tsao-Gung Canal's reach that runs by the prophyta garden is still mainly to its water quality. Parts of the waterways obviously were deposited with quite large volumes of sediments and the flows contained lots of suspensions.

However, as there are some non-governmental organizations established at local communities for preservation of sustainable environments (such as the Prophyta Garden Community and Empowerment Association of Kaohsiung City), the communities in other canal reaches to construct the water-friendly facilities construction are suggested to refer to the related practice made in this canal reach.

5. For the present situation of the Dianpu Bridge in Fongshan City where the Tsao-Gung Canal passes under, some of the hardware items of water-friendly facilities already designed are suggested to be revised, so as to make them more water-friendly; for example, the slopes of the canal's banks can be made less steep. By so doing the relevant community residents would be more willing to participate in the planning of such facilities. Besides, the aspect of safety at water playgrounds should be paid attention to.

## **2-6. Wetland Parks**

In the past agricultural development eras, both of natural and artificial wetlands in irrigation systems were mainly the irrigation ponds functioning to regulate the canal water. However, because of the previous land development in the Kaohsiung plain, most of the ponds had disappeared. The maintenance of canal waterways and preservation of paddy field ecology thus can make up the adverse impacts to the environments and ecology caused by the decreased water-surface areas. In recent years in the greater Kaohsiung area a series of planning of development of wetlands have been conducted. Under such circumstances the Tsao-Gung Canal is playing the role of water source supply to the wetlands of Shezilinpi, Jiufanpi and Zhouzi. The Canal will enable these wetlands to exist sustainably so that their ecological systems can be preserved.

Most of the natural wetlands in Taiwan's plain areas have been disappeared, but the promotion and management of paddy field ecology can correct the environmental and ecological problems due to lack of wetlands. It is also the key to restore traditional culture and reestablish land ethic. It is strongly suggests that the importance of paddy field ecology be fully recognized and practiced.

## **3. Survey on Opinions of Employees for Tsao-Gung Canal Service Area of Kaohsiung Irrigation Association**

This chapter was the focus of the second year program of the research work. It mainly surveyed the opinions of the on-site employees assigned in the service area of Tsao-Gung Canal (TGC) of Kaohsiung Irrigation Association (KHIA). In the course of the research, discussion meetings with them were held separately in seven working stations of the Association: Jiuqu, Daliao, Fongshan, Siaogang, Zuoying, Nanzih and Niaosong. The concerned employees and committee members of the Association were invited to attend these meetings. The main topics were on the multifunctional issues of community water-friendliness, wetlands, historical culture, ecological environments, R&L tourism and agricultural water use transfer in the service areas of respective working stations. The purpose was to probe in depth the changes and problems that the YGC encountered in recent years, in order to find out the future development orientation and directions of the aforementioned working stations, and

eventually to promote the achievements of PEL (agricultural production, ecology and life) and the multifunctional uses of water resources by KHIA. The conclusions of the discussing meetings at these seven working stations are respectively summarized in the following:

#### **4. Stakeholders' Comments on Multifunctional Uses and Development Strategies of Tsao-Gung Canal**

The main task of this study was to invite the stakeholders including related professionals and scholars, and local prominent people in the Association's TGC service area, to hold a forum for discussing about the desirable ways of multifunctional uses of the Canal and also its future development strategies. The purpose of the forum was to find out the sustainable management strategies for the Canal, so that KHIA and the stakeholders including the local and even central governments will be able to cooperate with each other and reform a whole brand-new TGC that will be adapted to the social and environmental changes in contemporary era.

In this chapter are summarized the achievements of the aforementioned forum as described below in accordance with the topics:

1. Agricultural management and development
2. Cultural assets
3. Contribution of the Tsao-Gung Canal to irrigation engineering and management, and its future perspectives
4. Agricultural water use transfer by Kaohsiung Irrigation Association (KHIA)
5. Community water-friendly facilities
6. Wetland parks

#### **5. Conclusions and Recommendations**

The Tsao-Gung Canal (TGC) over the past 170 years has transformed the people living in the now metropolitan Kaohsiung area from prosperous rural settlements into rich industrial societies; and will improve the health of tomorrow's cities in the area through sustainable water management. As the TGC is being developed as a canal of multifunctions, the promotion of the Canal's reconstruction has become the most important task.

This research was conducted on six basic aspects of development of the multifunctional uses of Tsao-Gung Canal:

1. Management and development of agriculture
2. Cultural assets and living in Tsao-Gung irrigation area

3. Contribution of the Canal to irrigation engineering and management and its future perspective
4. Irrigation water use transfer by Kaohsiung Farm Irrigation Association (KFIA)
5. Planning and promotion of water-friendly facilities in communities
6. Wetland parks

The six aspects above and the attention from stakeholders provided the directions for KFIA's further planning of the Tsao-Gung Canal's multifunctional roles. Complete discussions were conducted which scope included the preservation of cultural assets, and construction of the present irrigation-related facilities to long-term schemes in the future. It is anticipated that KFIA would make good use of it and get into detailed planning and construction of TGC, so that its environments would conform to the requirements of PEL and coherent with the future development, and its management and development would be sustainable.

However, while the hardware installations are complete, the people living in, and even out of the Tsao-Gung irrigation area should form related organizations to share the responsibilities of maintaining and managing the new canal hardware and local cultural relics, and enhancing the special humanity tradition nurtured by Tsao-Gung Canal. By doing so the Canal will be enabled to continue nurturing multiple local culture.

The role of the related government agencies is also a very important part. Although KFIA is a public judicial body, it doesn't have any legal authority, and its funds are mostly relied on supports from the related agencies, which are the obstacles to the Association in the management and maintenance of canals. If the related agencies could be integrated in cooperation with KFIA in management and construction of Tsao-Gung Canal, it is for sure that the Canal's service efficiencies and achievements would be increased, and past achievements revitalized.

The related central agencies, the Kaohsiung City and Kaohsiung County Governments, KFIA, and related community organizations as well as community residents are related to each other and each one of them is a key part in the sustainable development of Tsao-Gung Canal. The planned merger of Kaohsiung County and City in the year of 2010 will be a huge advantage for the multifunctional development of Tsao-Gung Canal. It is hoped that the event of merger would facilitate the planning and reconstruction of a complete and flawless Tsao-Gung Canal, which would make the Canal fully play its functions of irrigation and



flood-prevention, and also the people enjoy its functions and natural rural sceneries, and futhurmore the foundations for the future it establishes.

## REFERENCE

Fu- Ming Chiang , 2007. Multifunctional Uses and Development Strategies of Tsao-Gung Canal :Management and Development of Agriculture, Tsao-jiin Foundation.

hen-Der Wang and Po-Yuan Yang , 2007. Multifunctional Uses and Development Strategies of Tsao-Gung Canal :The Cultural Herbage of Tsao-kung Irrigation System, Tsao-jiin Foundation.

Ming-Young Jan , 2007 . Multifunctional Uses and Development Strategies of Tsao-Gung Canal :Contribution On the Agriculture and Future Perspective, Tsao-jiin Foundation.

Sheng-Feng Kuo , 2007 . Multifunctional Uses and Development Strategies of Tsao-Gung Canal :Canal Planning for Community Entertainment, Tsao-jiin Foundation.

Chung-hsin Juan ,2007 . Multifunctional Uses and Development Strategies of Tsao-Gung Canal :Constructed wetland parks, Tsao-jiin Foundation.

Jung-Hsiang Lu, Guo-Long Lee ,Shu-shr Yeh and Jung-Shui Wang , 2007 . Multifunctional Uses and Development Strategies of Tsao-Gung Canal : Agricultural Water Use Transfer in Kaohsiung Farmland Irrigation, Tsao-jiin Foundation.

Jung-Hsiang Lu, Guo-Long Lee ,Shu-shr Yeh and Jung-Shui Wang , 2008 . Survey on Opinions of Employees for Tsao-Gung Canal Service Area of Kaohsiung Irrigation Association, Tsao-jiin Foundation.

Jung-Hsiang Lu, Guo-Long Lee ,Shu-shr Yeh and Jung-Shui Wang , 2009 .Stakeholders' Comments on Multifunctional Uses and Development Strategies of Tsao-Gung Canal, Tsao-jiin Foundation.



## 附 錄 六

### 會議影像集錦



## 會議影像集錦



第 61 屆國際執行委員會議(IEC)－主席團



第 61 屆國際執行委員會議(IEC)  
左起-莊光明主席及吳瑞賢副秘書長出席會議



第 61 屆國際執行委員會會議(IEC)－各國家委員會參與議案表決



CTCID 簡介、台灣灌溉史及因應氣候變遷等文宣展示品



全體團員於印尼會議中心合影



全體團員於印尼會議中心合影



ICID 主席 Chandra A. Madramootoo(中)與台灣代表合影



ICID 副主席-印尼(前排右二)與台灣代表合影





亞洲區域工作小組會議-台灣代表與會情形  
後排左起-陳伸賢執行長、高瑞棋副所長、莊光明主席、郭勝峰教授



亞洲區域工作小組會議—台灣代表與會情形  
左起-江明郎副局長、林國華技正



全球氣候變遷與灌溉工作小組會議-台灣代表共同主持  
左起-Dr. Mark Svendsen(美國)、吳瑞賢教授(台灣)、Dr. Tsugihito Watanabe(日本)



環工作小組會議—台灣代表與會情形  
左起-陶方策工程師、吳瑞賢教授



現代化灌溉服務工作小組-台灣代表發表專題簡報

左起- Dr. Mauris Ertsen(荷蘭)、舒文斌博士(台灣)、Dr. Willem F. Vlotman (澳洲)



現代化灌溉服務工作小組-台灣代表與會情形

前排右起-周師文總幹事、廖文藝副工程師、林元麒辦事員  
後排右起-張連對股長、陳志中副管理師



感潮區域永續發展工作小組-台灣代表與會情形

右排前起- 詹明勇教授、鄭昌奇教授、劉珺貽助理、王筱雯助理教授、高瑞棋副所長



乾旱工作小組-台灣代表與會情形

右二-鄭昌奇教授



第 6 屆亞洲區域研討會：鄭昌奇教授論文發表



第 6 屆亞洲區域研討會：舒文斌博士論文發表



會場展覽



參觀會場展覽

右起-鄭昌奇教授、詹明勇教授、陳仲賢執行長、舒文斌博士

第六十一屆國際灌溉排水協會國際執行委員會會議暨第六屆亞洲區域研討會議

印尼・日惹

民國九十八年十月