

經濟部所屬各機關因公出國人員報告書

(出國類別:出席國際研討會)

廢水處理回用

服務機關：台灣中油公司煉製研究所

姓名職稱：張士元/化學工程師

派赴國家：美國

出國期間：98年6月13日至6月22日

報告日期：98年9月21日

摘 要

薄膜技術已愈來愈廣泛的被使用於水及廢水處理，因此利用參加美國水工協會 (American Water Work Association, AWWA) 今年的年會(2009 Annual Conference & Exposition，簡稱 2009ACE) 的機會蒐集相關的資訊，文中包括：1. 世界上最大的使用浸式超過濾膜技術來製造高品質飲用水的水處理場之一--雙橡谷水處理場(Twin Oak Valley Water Treatment Plant)、2. 先進的污水處理回收廠—聖地牙哥南灣水回收場(South Bay Water Reclamation Plant, SBWRP)、3. 國外煉油廠進行廢水處理回收採用之技術及趨勢、4. 對本公司煉油石化廠未來廢水薄膜處理回收的探討。

目 次

壹、目的	1
貳、過程	1
一、雙橡谷水處理場(Twin Oaks Valley Water Treatment Plant)	2
二、南灣水回收場(South Bay Water Reclamation Plant, SBWRP)	5
三、低壓薄膜處理技術(Low Pressure Membrane Technology)	9
四、國外以薄膜技術進行煉油廠水及廢水處理回收案例	27
五、2009ACE 照片介紹	38
六、WesTech 公司煉油廢水處理與回收技術.....	39
七、國內含油廢水薄膜處理回收情形.....	41
(一) 台塑六輕節水及水回收.....	41
(二) 中美和廢水處理回收	42
(三) 中鋼廢水回收興建計畫	44
(四) 本公司林園廠廢水處理回收	45
參、心得與建議	47
肆、附件	50
(一)2009ACE 內容	50
(二)2009ACE 參考廠商	54

本 文

壹、 目的

台灣每年下雨量雖然充沛，然而大部份雨水直奔大海，不易貯留，以致每逢乾旱即發生缺水的問題，影響產業正常營運甚鉅。近幾年，政府大力鼓勵產業節水及要求做好廢水回收。如本公司石化事業部的三輕更新、煉製事業部的煉製結構改善、未來彰化大城的國光石化科技園區的投資，環評上，都要做到水資源回收再利用。為因應缺水的危機及達到環評上的成要求與承諾，本公司正積極發展適用於自己廢水特性的水處理回收技術。

美國水工協會(American Water Work Association, AWWA)成立於 1881 年，至今已有 128 年歷史，目前有超過 60,000 個會員，為美國相當重要的水及廢水處理專業團體。AWWA 每年固定舉辦年度研討會，對於水科技的整合提昇、造水產業的發展及政府相關法令的擬定都有很大的影響力。今年(2009)的年會於 6 月 14-18 在美國加州聖地牙哥舉行，總共 17 個講習會，100 多場會議及 500 多家參展廠商，此外也包括參訪行程及海報展示..等。奉派參加本次的研討會主要目的為蒐集以煉油廠為主要對象的水處理及廢水處理回用技術，同時參訪相關的水及廢水處理回收廠。

貳、 過程

本次出國總共十天，行程如下：

預定起迄日期	天數	到達地點	詳細工作內容
98.06.13	1	桃園-洛杉磯-聖地牙哥	由桃園啟程往美國聖地牙哥
98.06.14	1	聖地牙哥	AWWA2009ACE, Desalination Workshop
98.06.15	1	聖地牙哥	AWWA2009ACE, 蒐集產業資訊
98.06.16	1	聖地牙哥	AWWA2009ACE, 蒐集產業資訊, 參訪 South Bay Water Reclamation Plant
98.06.17	1	聖地牙哥	AWWA2009ACE, 蒐集產業資訊
98.06.18	1	聖地牙哥	AWWA2009ACE, 蒐集產業資訊
98.06.19	1	聖地牙哥-洛杉磯	拜訪 WesTech 公司, 請教討論廢水處理回用技術
98.06.20	1	洛杉磯	拜訪 WesTech 公司, 請教討論廢水處理回用技術
98.06.21	1	洛杉磯-桃園	由洛杉磯返回台灣
98.06.22	1	洛杉磯-桃園	抵達台灣
合 計	10		

研討會範圍包括

1. 淨水廠操作及配水(Distribution & Plant Operation)
2. 工程及建設(Engineering & Construction)
3. 執行管理(executive)
4. 立法及規章(Legislative & Regulation)
5. 經營管理(Management)
6. 廠造業者(Manufacturers/Associates)
7. 公共事務論壇(Public Affairs& Public Interest Advisory Forum)
8. 研究方面(Research)
9. 廢棄物(Residuals)
10. 水回用(Reuse)
11. 小型處理系統(Small System)
12. 節水(Water Conservation)
13. 水質(Water Quality)
14. 水資源(Water Resources)
15. 專題討論(Special Topics)
16. 大學論壇(Universities Forum)
17. 海報張貼(Poster Sessions)

以下報告以煉油廠為主要對象的水處理及廢水處理回用技術，及參訪相關的水及廢水處理回收場。

一、 參訪雙橡谷水處理場 **Twin Oaks Valley Water Treatment Plant**

雙橡谷水處理場(Twin Oak Water Treatment Plant)是世界上最大的使用沉浸式中空纖維超過濾膜(Submerged Hollow Fiber Ultra-Filtration Membrane)技術，來製造高品質飲用水的水處理場之一，每日提供 100 萬加崙的飲用水，供給北聖地牙哥郡約 22 萬戶的家庭使用。

2005 年聖地牙哥郡水資源局(San Diego County Water Authority, SDCWA)市為了在最快時間內解決該郡的緊迫的自來水供需問題，在諸多的顧問工程公司中評選出

CH2M HILL 公司，採用設計-建造-操作(Design-Built-Operate, DBO)的方式進行整個計畫作業。僅用 30 個月的時間，CH2M HILL 公司在 2008 年 4 月就完成整個工程，並開始供應可直接生飲的自來水。

CH2M HILL 成立於 1946 年，目前全球共有約 25000 員工，2007 年總收入達 51 億美元，為一跨足化學、能源、環保..，大型工程顧問公司。CH2M HILL 以 1 億 5 仟 7 百萬美元取得標案，比第二競標者約少 4%，並同時取得未來 15 年，每年 600 萬美元的操作維護費(在最大能源使用額度下，包括所有設備之操作、維護、更新及廢棄物處理)，這也比第二競標者約少 8%，其所以能在眾多競爭者中勝出，除了有強大的團隊能力，做到優良的工程品質、時間、環境管理及與居民互動外，很重要的是採用 ZENON 公司先進的沉浸式超過濾膜技術。本工程也得到 2009 美國環境工程師學會(American Academy of Environmental Engineers)最佳設計獎的榮譽。

美國一般水處理的處理流程大致為：原水 → 化學混凝沉澱 →、臭氧氧化 → 生物活性碳 → 添加氯氣 → 貯水塔 → 配水。CH2M HILL 所設計的處理流程為：原水 → 細篩 → 浸式超過濾膜 →、臭氧氧化 → 生物活性碳 → 添加氯氣 → 貯水塔 → 配水。整個處理程序幾乎達到廢水零排放。

各處理單元之功能為：

- A. 細篩單元 -- 去除泥沙顆粒
- B. 浸式超過濾膜單元 - 去除微小膠體
- C. 臭氧單元—初步殺菌、味道及氣味控制
- D. 生物活性碳單元 --- 去除有機物質
- E. 次氯酸製造機 -- 殺菌(免於運送次氯酸)

下圖為 Twin Oaks Valley 所使用之處理技術與傳統之水處理技術的比較：

**Membrane Treatment
At Twin Oak Valley**

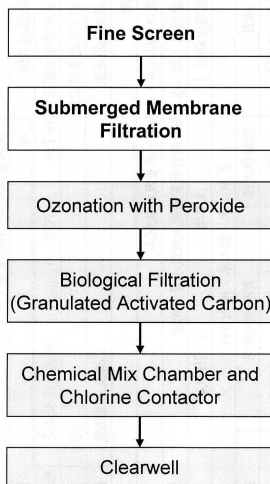

**Comparable
Conventional Treatment**

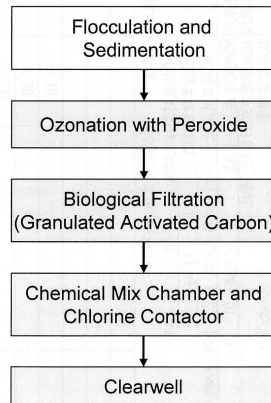

similar
for both
treatment
processes

二、 南灣水回收場(South Bay Water Reclamation Plant, SBWRP)

聖地牙哥本身缺水，90%的水源來自科羅拉多河(Colorado River)，為了減輕用水壓力，促使聖地牙哥市政府積極進行水回收再利用。在此一情形下，不同以往之廢水處理場(Wastewater Treatment Plant)的設計概念，南灣水回收場(South Bay Water Reclamation Plant, SBWRP)應運而生。

南灣水回收場位於聖地牙哥與墨西哥交界之 Tijuana 河谷，負責處理鄰近地區之都市生活廢水，採用當時最先進之技術，於 2002 完工，設計最大處理量 15MGD，目前處理量為 9MGD，總工程費 US\$99,588,000，硬體包括：三級處理設備、管理大樓、化學藥劑廠房及停車場。其處理程序包括：攔污柵、沙礫去除槽、初沉池、調節池、活性污泥生物處理、二級沉澱槽、混凝、過濾、紫外光殺菌等。

原廢污水進入處理場後先經攔污柵(Bar Screen)單元去除較大的固形物，這些固形物脫水後送掩埋場處理。接著廢污水進入曝氣沙礫去除槽(Aerated Grit Chambers)單元去除比重較大的小固體。同樣地，這些較小的固體經脫水後也送掩埋場處理。這二個單元均設有空氣處理設備，臭氣經收集後先經漂白水(次氯酸鈉)溶液淋洗，以去除硫化氫等臭味，再經活性炭吸附其餘揮發性有機物，合格之後排入大氣中。

廢污水再進入初沉池(Primary Sedimentation Basins)，經靜置後去除沉降的污泥及上浮的浮渣等物。為了節省投資成本，這些污泥及浮渣利用既有管線，送往約距 18 英里海邊之 Point Loma Waste Water Treatment Plant(PLWWTP) 廢水處理場 (處理量 175MGD，1963 年啟用) 一起處理。

廢污水接著進入活性污泥生物處理槽之缺氧區 Anoxic Zone，在此區產生脫硝反應，硝酸氮部份被還原成氮氣而逸至大氣中。Anoxic 區後為曝氣池(Aeration Basins)，提供空氣使好氧微生物分解廢污水中有機物，活性污泥濃度 1,800-2,000mg/L，水力停留時間 8 小時，之後廢水流入二級澄清池(Secondary Clarifier)，部份生物污泥迴流到 Anoxic 池，剩餘污泥則送到 Point Loma 廢水處理場脫水及做最終處理。

二級澄清池出流水 BOD<5mg/L，SS<30mg/L，符合加州嚴格的海洋放流的標準，部份經由海放管送到 3.5 英里外的南灣海域，其餘經過無煙煤濾床三級過濾，進一步去除懸浮固體後回收，供應給客戶當次級水使用，主要當澆灌草坪之用，水質符合加州人體全接觸(State Title 22 Full Body Contact)法令標準。

未來當總處理量達到 15MGD 時，扣除約 10%的水量，即 1.5MGD 用於南灣水回收

場本身當逆洗、隨剩餘污泥外送 PLWWTP 及處理中揮發損失外，約 13.5MGD 可以經三級無煙煤濾床處理後回收。除了細菌數、COD 及 pH 之外，另一個重要的水質控制項目是總溶解固體(Total Dissolved Solid, TDS)，其上限為 1000mg/L。聖地牙哥市北水回收場(North City Water Reclamation Plant, NCWRP)為了 TDS 超過上限值，增設了一套逆轉電透析(Electrodialysis Reversal, EDR)進行脫鹽，以符合回收水質規範。但是 SBWRP 目前水質無 TDS 過高的問題，若將來萬一過高，SBWRP 並不打算增設 EDR，而是會將較高 TDS 濃度的廢水分流(已調查清楚)，送到 NCWRP 一併處理，其餘低 TDS 仍在 SBWRP 處理，以節省處理成本。

聖地牙哥市政府亦曾評估薄膜生物處理(Membrane Biological Reactor, MBR)的效果，其以(1)沉砂池出流水及(2)先進初級處理出水(Advanced Primary Effluent)進行四種 MBR 測試，評估薄膜阻塞、水質水量穩定情形，都得到不錯的結果，MBR 系統價格每 1000 加崙約\$1.81-\$2.23 之間。大系統如 10MGD，其建造價格約\$1.38-\$1.66 之間。



圖一 SBWRP 地理位置圖

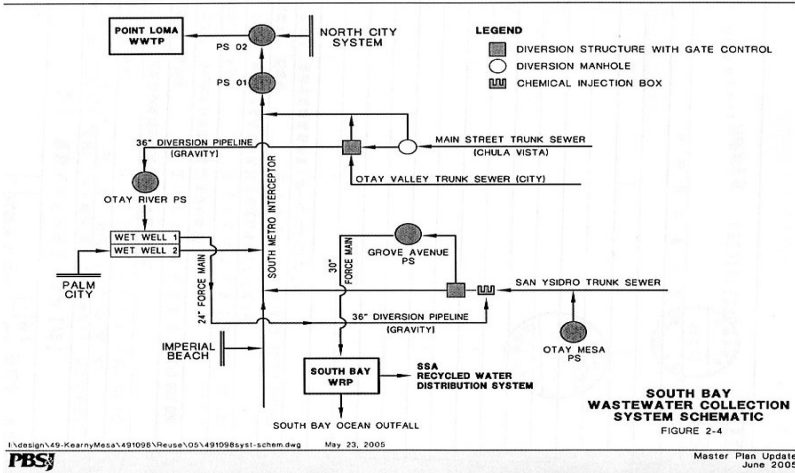

圖二 聖地牙哥南灣地區廢水收集示意圖

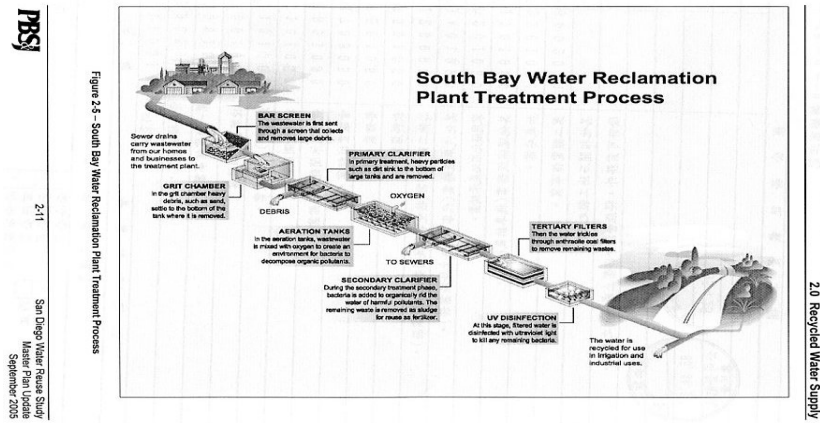

圖三 南灣水回收場處理流程示意圖

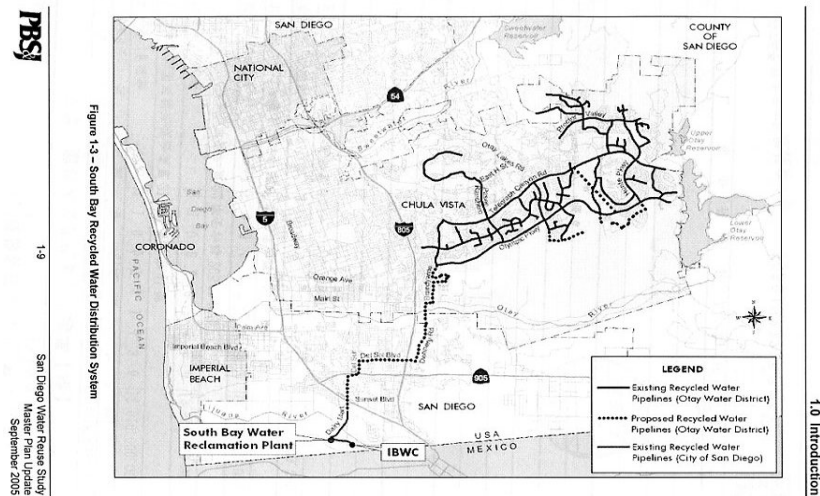

圖四 SBWRP 回收水供應地區及管線配置

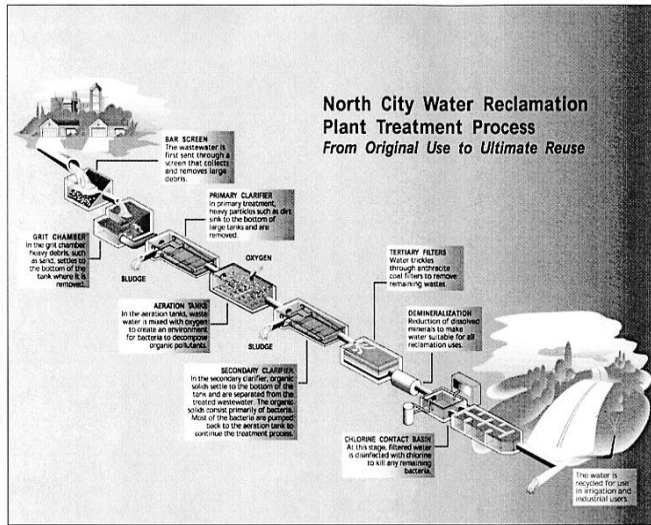

圖五 市北水回收場(NCWRP)處理流程示意圖

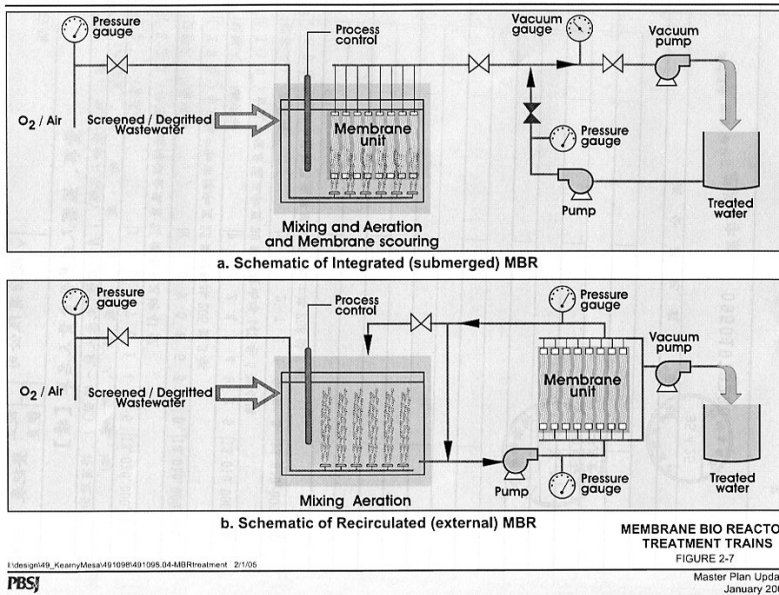

圖六 MBR 處理廢水方式示意圖

三、 低壓薄膜處理技術(Low Pressure Membrane Technology)

決定逆滲透(Reverse Osmosis, RO)處理成敗，做為 RO 前處理的低壓薄膜處理技術—MF/UF(Microfiltration/ Ultrafiltration)，過去 12 年隨著科技的進步，全球 MF/UF 處理量從 1998 年的 500MGD 達到如今超過 4,000MGD。MF/UF 在水及廢水處理上被證實可以提高處理的效果，同時降低了處理及土地成本。因此特別蒐集這方面的資料，瞭解北美 MF/UF 技術主要廠商及其主要產品。

(一)Low Pressure Membrane Definition

- MF(Microfiltration) and UF(Ultrafiltration) are called Low Pressure Membranes (<50psi Feed Pressure except Ceramic Membrane)
- Remove Particulates Only
- Typical MF Pore Size: 0.1-0.5 μm
- Typical UF Pore Size: 0.01-0.05 μm
- Do not Remove Dissolved Solids

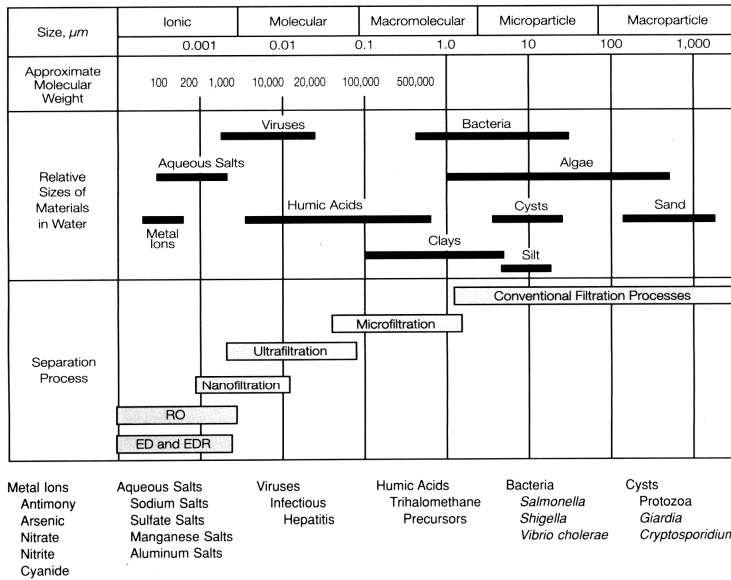

Drastic Increase in Low Pressure Membrane Installations in the Last 10 - 12 Years

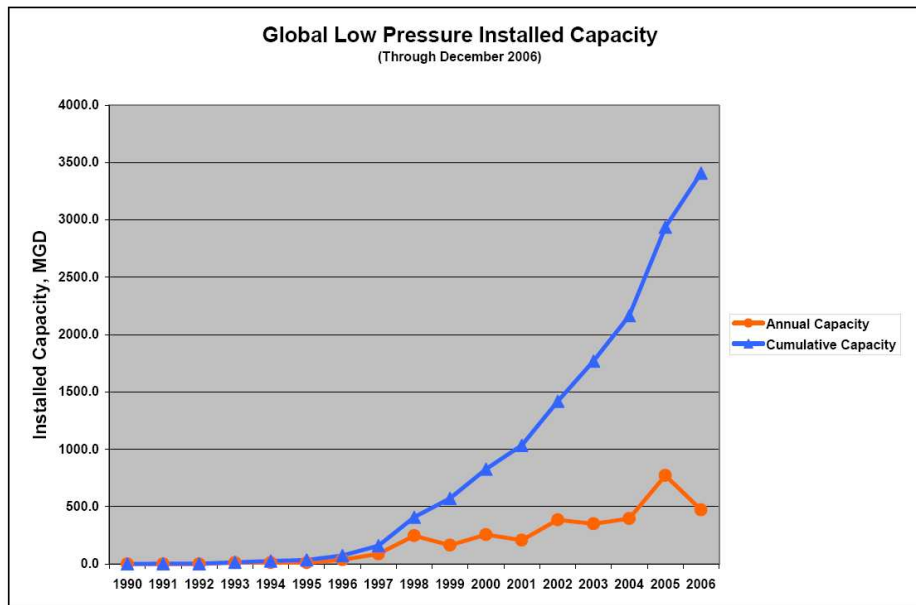

(二) Reasons for Using Low Pressure Membranes (MF/UF) in Water Treatment

- Membrane Technology Advances
- Drastic Reduction in Membrane Costs
- More Compact than Conventional Systems
- Higher Effluent Quality
- Reliability and Automation Capability

Microfiltration vs. Ultra-filtration in Removal Efficiencies

Microbe	Microfiltration	Ultrafiltration
Giardia Cysts	4.5-7 log	5-7 log
Cryptosporidium	4.5-7 log	5-7 log
MS-2 Bacteriophage Virus	0.5-3.0 log	4.5-6 log
Particle Counts		
>2 micron	<10/ml	<10/ml
2-5 micron	<10/ml	<10/ml
5-15 micron	<1/ml	<1/ml
Turbidity - Average	0.01-0.03 ntu	0.01-0.03 ntu

(三)MF/UF Configurations

- Tubular
- Hollow-Fiber
- Spiral Wound
- Disk/Plate
- Ceramic

Hollow-Fiber MF/UF Membranes

- Most Popular In Water Treatment, Wastewater Reuse and Membrane Bioreactor (MBR)
- Frequent Backwash Capability
- High Surface Area to Volume (Packing Density)
- Low Pressure Drops Across Module
- Cost Reduction with Larger Modules

Process Flow Diagram of Submerged MF/UF System (<-12 psi)

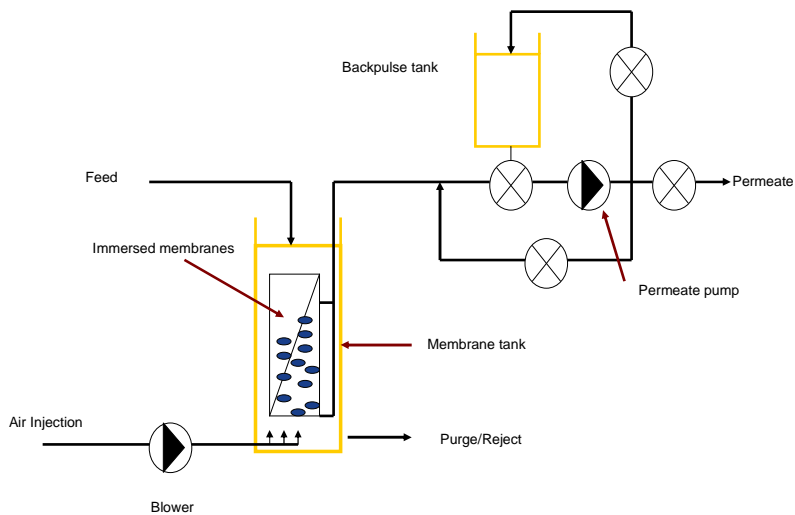

Process Flow Diagram of Pressure MF/UF System (<40 psi)

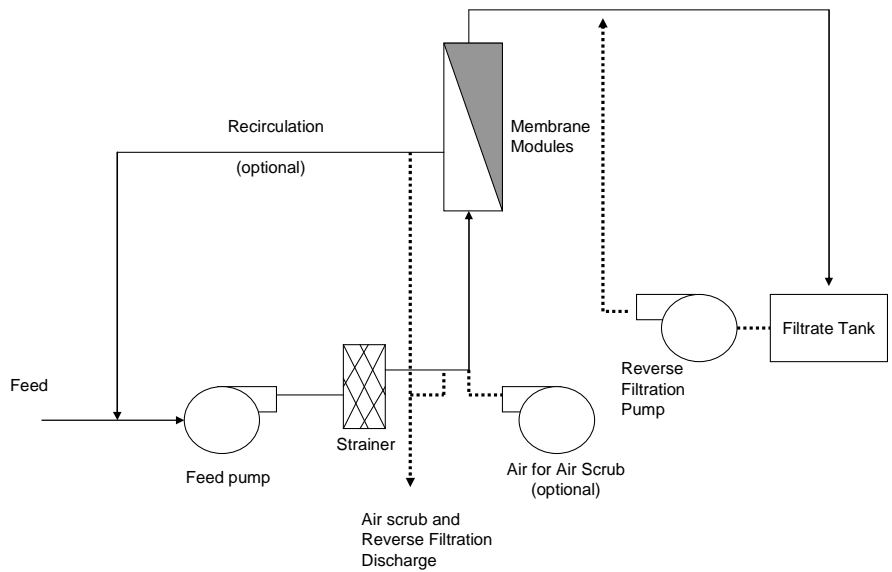

(四) Summary of Major Hollow-Fiber MF/UF Technologies in N. America

Technology/ Vendor	MF or UF	Pressure or Submerged	Membrane Material	Pore Size or MWCO	Backwash Procedures	Flow Pattern
GE/Zenon ZeeWeed®	UF	Submerged/ Pressure	PVDF	0.04-0.02 μm	Air/water	Outside-In
Siemens/ Memcor	MF/UF	Pressure/ Submerged	PPL and PVDF	0.2-0.04 μm	Air/water	Outside-In
Pall (Asahi) Microza	MF/UF	Pressure	PVDF/PAN	0.2 μm/ 13,000 or 80,000	Air/water	Outside-In
DOW	UF	Pressure	H-PVDF	0.03 μm	Air/water	Outside-In
Infilco Degremont AquaSource	UF	Pressure	Cellulose Acetate	0.01 μm	Water only	Inside-Out
Koch Romicon®	UF	Pressure	Polysulfone	10,000 to 100,000	Water only	Inside-Out
Norit XIGA™	UF	Pressure	PVP/PES	0.03 μm	Water only	Inside-Out
Hydranautics HYDRAcap	UF	Pressure	PES	100,000 to 150,000	Water only	Inside-Out

1.GE/Zenon ZeeWeed® Membrane

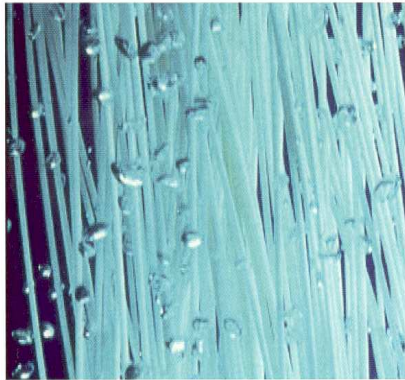

1 Photo of ZeeWeed® Hollow Fibre Membrane Bundle

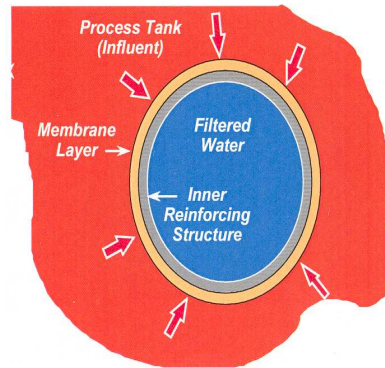
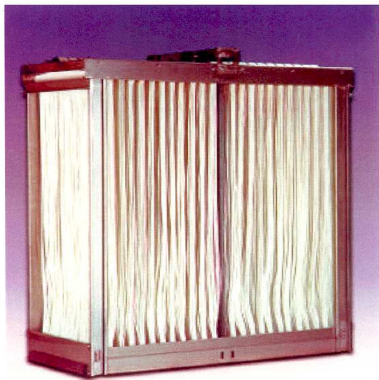
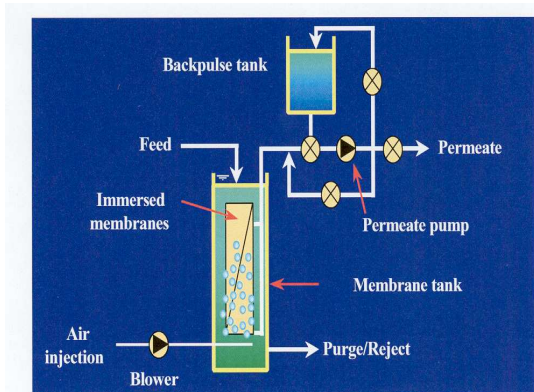

Figure 2 Cross Section of ZeeWeed® Fiber

Zenon ZeeWeed® (Outside In)



ZeeWeed® 500c Membrane Module Cassette



ZeeWeed® Process Flow Diagram

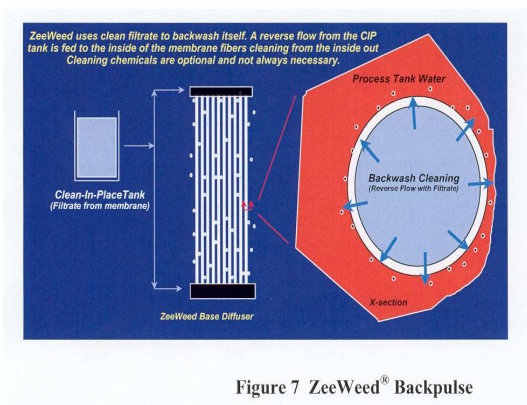

Figure 7 ZeeWeed® Backpulse



THORNTON 40 MGD ZW 500 SYSTEM



ZeeWeed 1000 Module



ZeeWeed 1000 Cassette

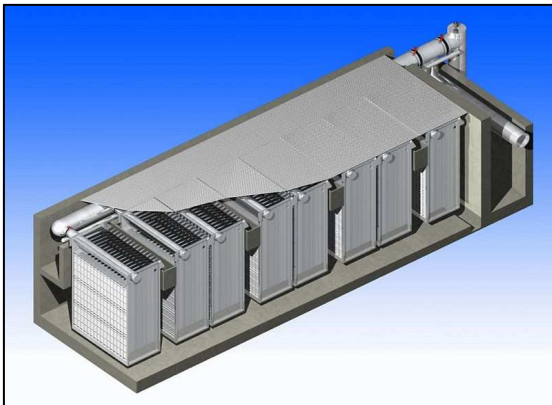

ZeeWeed 1000 Train



40 MGD SSJID ZW 1000 System
(Covered Tanks)

ZeeWeed 1500 Pressure UF Membrane

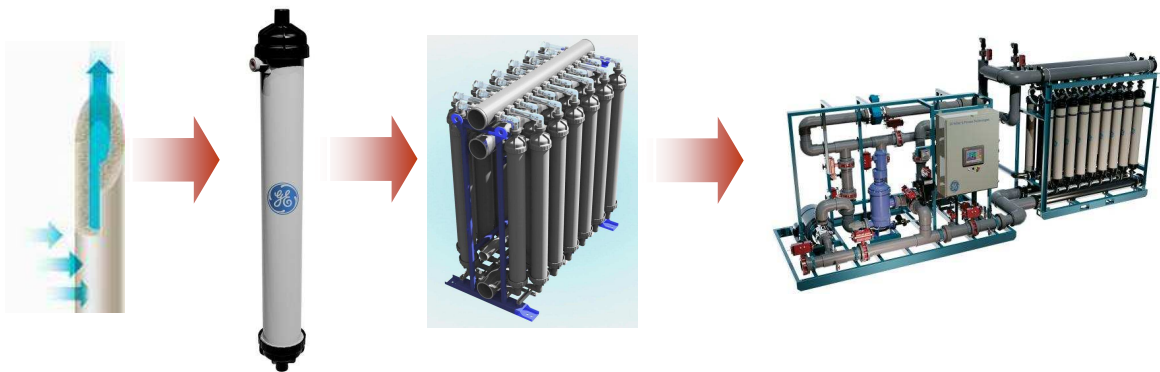

ZW1000 & ZW1500 Positioning

	ZW1000	ZW1500
Direct Filtration Average Turbidity	< 50 ntu	< 50 ntu
Enhanced Coagulation Average Dose (mg/L)	< 40 mg/L	< 40 mg/L
Tertiary Treatment Average TSS (mg/L)	< 30 mg/L	< 30 mg/L
Sea Water Average TSS (mg/L)	< 50 ntu	< 50 ntu

2.Siemens/Memcor Submerged MF/UF Membrane (Outside In)

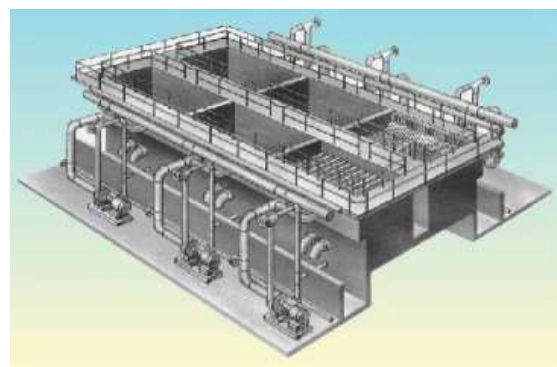
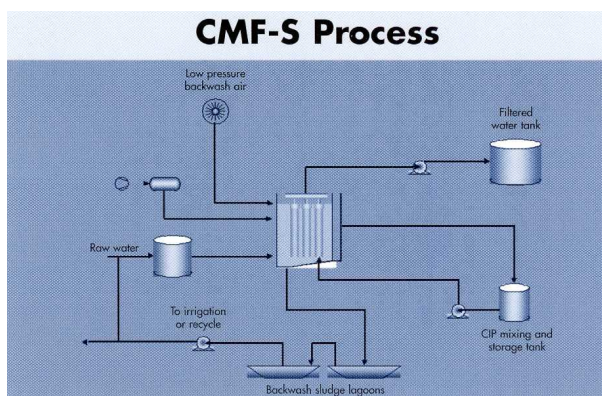

3. Memcor L10 and L20 Modules

Property	L10	L20
Material	PVDF	PVDF
Pore Size	0.04µm (UF)	0.04µm (UF)
Length	3.2 ft (1.0 m)	5.9 ft (1.8 m)
Membrane area	252 ft ²	410 ft ²
Module weight	14 lbs.	20 lbs.



Memcor Submerged Manifolds

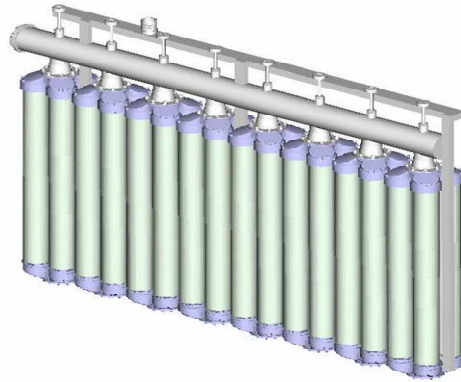

Memcor CS Submerged Membrane System

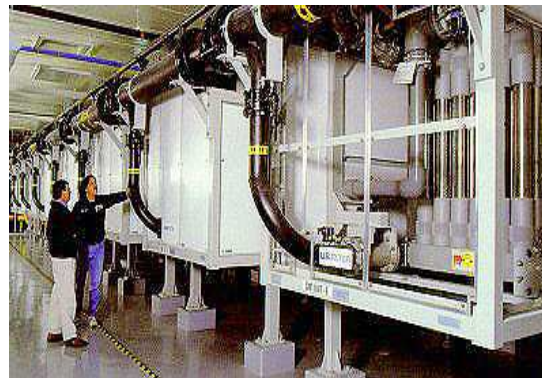

Siemens/Memcor Pressure MF Membrane (Outside In)

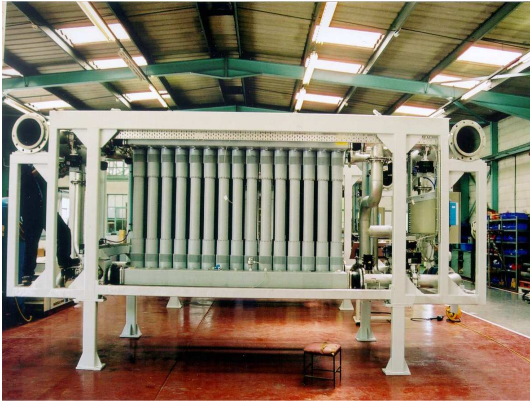

Memcor CP Pressure System

4.Koch Pressure UF Membrane (Inside Out)



RomiPure water filtration cartridges

Koch Package UF Plants < 1 MGD

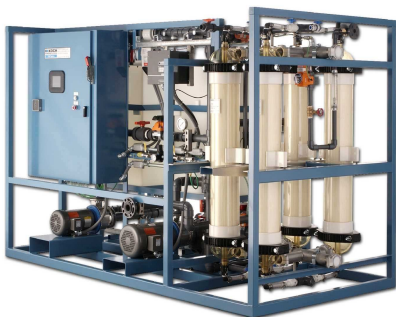

3 MGD Koch UF System in CAPCO

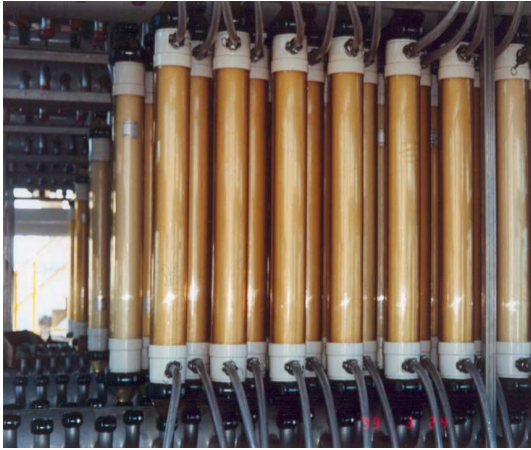

UF Cartridges (Koch Membrane)

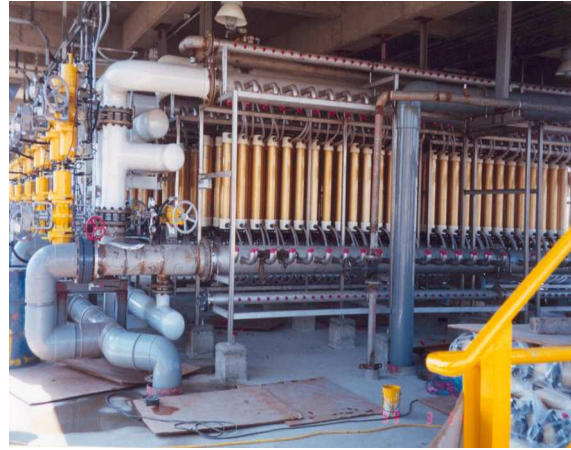

UF System

5. Pall (Asahi) Pressure MF/UF Membrane (Outside In)

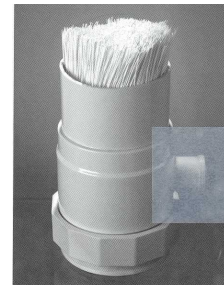
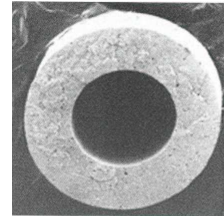
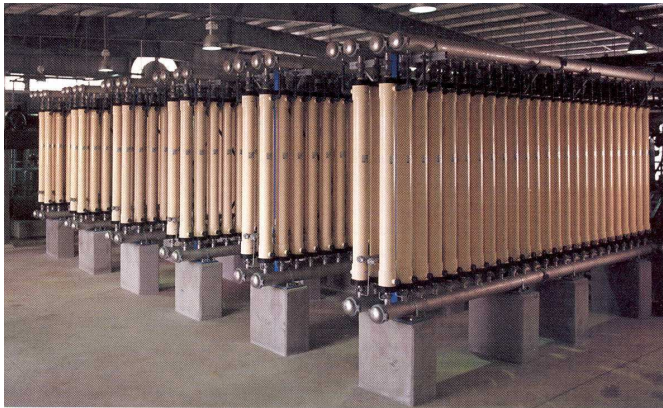

Pall Membrane Module

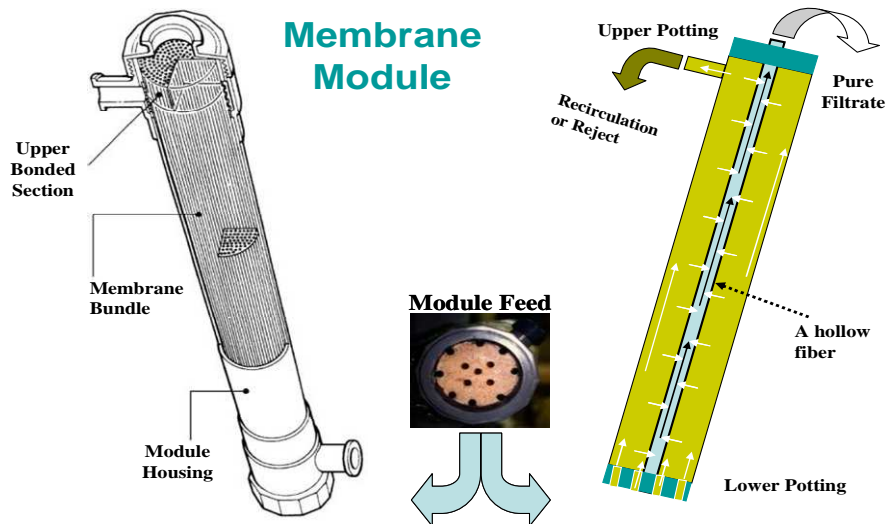

6. Norit X-Flow Pressure UF Membrane (Inside Out)

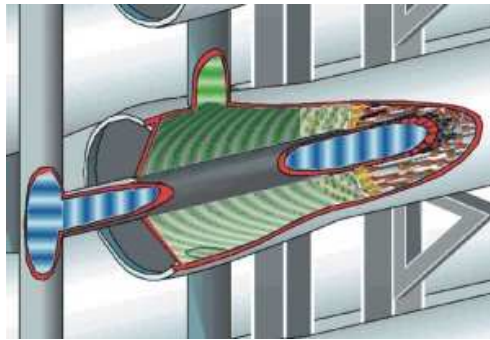

Municipal waste water effluent recycling

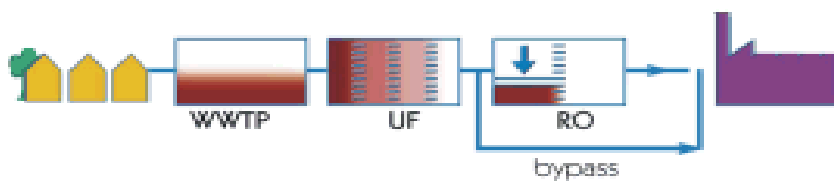

Norit X-Flow XIGA Concept

Properties XIGA™ system:

- **Dead-End** -> low energy consumption, simple design
- **Horizontal** -> easily accessible and small footprint
- **8 inch** -> world standard for RO Interchangeability of membranes
- **Inside-out** -> solids retained in defined space optimal backwashability

Norit X-Flow XIGA Concept, Principles 1

8" X-Flow UF insert (40 m²)
0,8 mm fiber diameter
max. pore size: 25 nm

Corrugated plates:
optimal hydrodynamics

Bypass tubes:
minimal pressure loss in housing

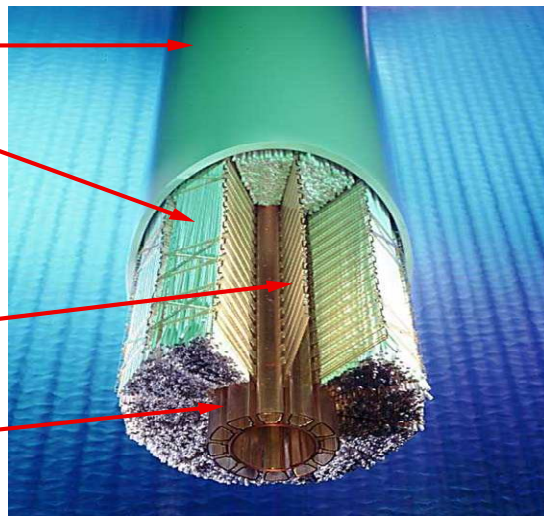

7. Infilco Degremont's Aquasource Pressure UF Membrane (Inside Out)

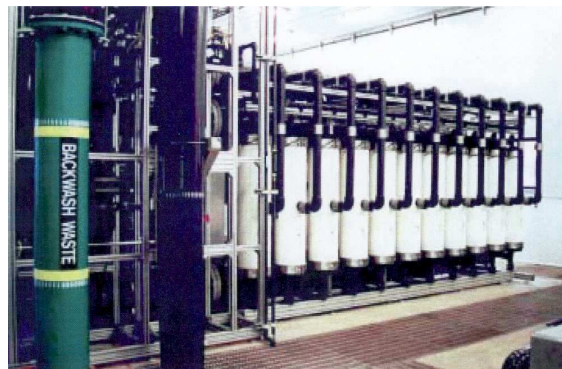
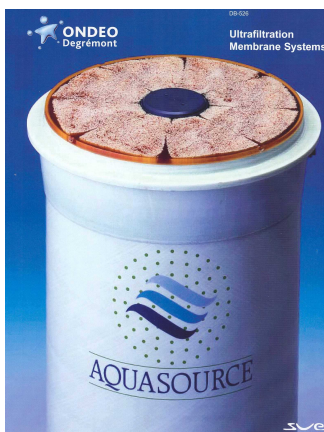

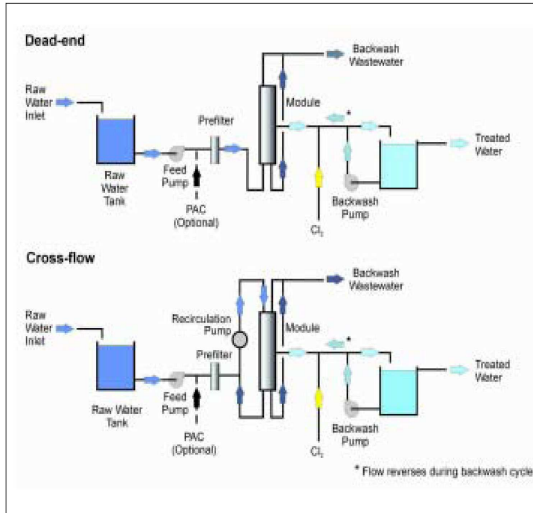

The Aquasource Process

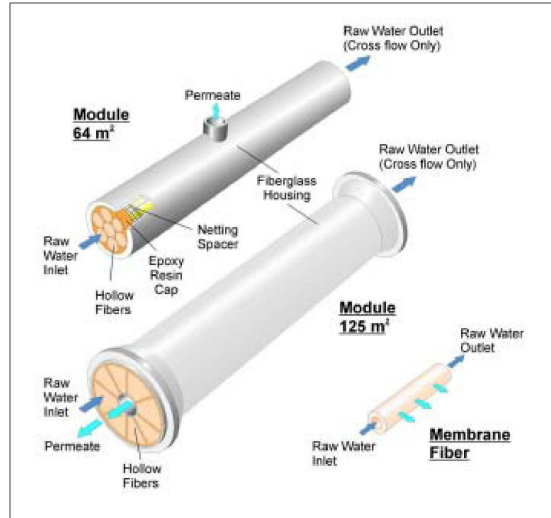

Aquasource Modules



Aquasource Modules in a Rack



Aquasource System

8. Hydranautics HYDRAcap Pressure Membrane (Inside Out)

HYDRAcap 60 24-module configuration*
Typical Filtrate Flow 240 - 640 gpm, (55 - 145 m³/hr)
Footprint (W x L x H) 5' x 14' x 9' (1.5 x 4.3 x 2.7m)



*This modular sub-bloc can be stacked to create larger HYDRABLOCs. One HYDRABLOC can accommodate up to 144 HYDRAcap 60 modules in a 3 x 2 bloc configuration.

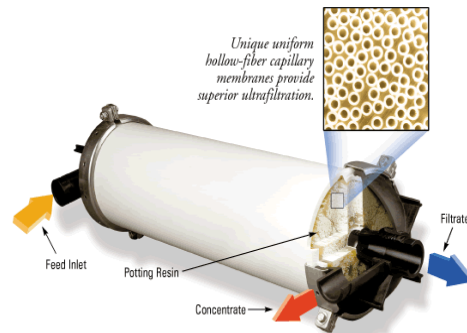

HYDRAcap UF Racks for Wastewater Reuse at Power Plant

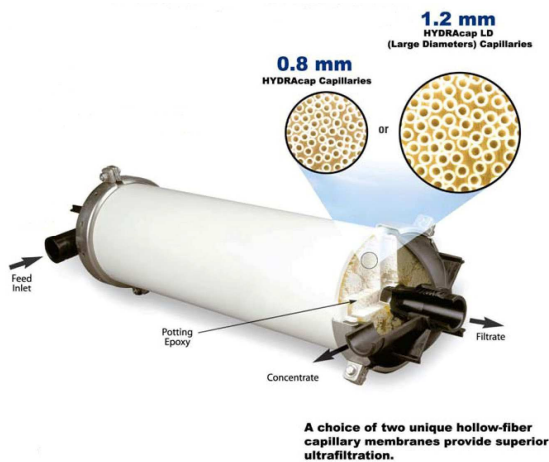

HYDRAcap 2 Module Sizes

3 UF Racks Produce 2.1 MGD Product Water for RO Feed

9. DOW™ UF Membrane



- Pressurized Outside/In Modular Membrane Product
- Wide Ranging Feed Water Tolerance
- Simple Vertical Shell-and-Tube Design
- Dead-End (energy savings)
- Allows Air Scour

- 1.3 mm x 0.7 mm H-PVDF Hollow Fibers
- High Strength and Toughness
- High Chemical and Temperature Resistance
- Treated for Increased Hydrophilicity

- 0.03 μ m Nominal Pore Size
- Double Walled Hollow Fibers with Minimal Macrovoids
- Combines Excellent Filtration Performance with High Flux
- Stable Long Term Filtration Performance

DOW™ UF Specifications

Operating Ranges		
	SI	US
Typical Filtrate Flux Range @ 25°C	40–120 L/m ² h	24–70 gfd
Temperature (limited by UPCV)	1– 40 °C	34–104 °F
Maximum Inlet Module Pressure	6.0 bar	87 psi
pH	2 - 11	
NaOCl Cleaning Maximum	2000 ppm	

Dow UF System Operation

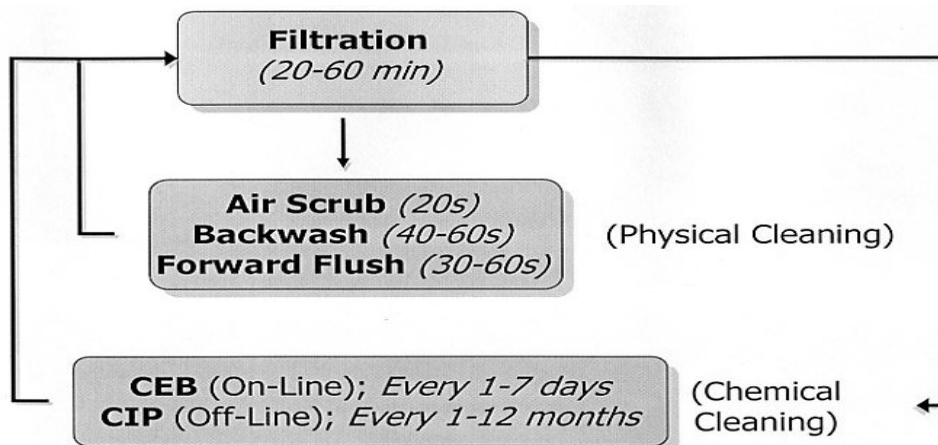

- Chemically Enhanced Backwash (CEB)
- Clean In Place (CIP)

Dow UF Installation in China



10. Ceramic Membranes (MF) by NGK

- High Mechanical Strength Inorganic Material (>15 Year Life)
- High Flux (to >100 gfd)
- High Pressure Can be Used for Backwashing (70 psig) to Extend Filter Runs (2-6 Hours)
- >30 Drinking Water Plants (<0.1 mgd) Since 1998 in Japan
- 10-mgd WT Plant in Fukui, Japan Commissioned in December 2006
- Represented by Krüger in U.S.

Structure of Ceramic Membrane

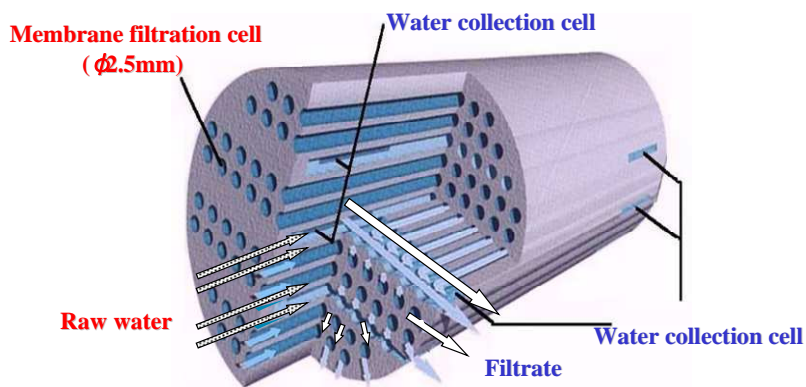



Ceramic Membrane Element Specifications



Ceramic Membrane Modules

Schematic of NGK Ceramic Membrane Filtration System

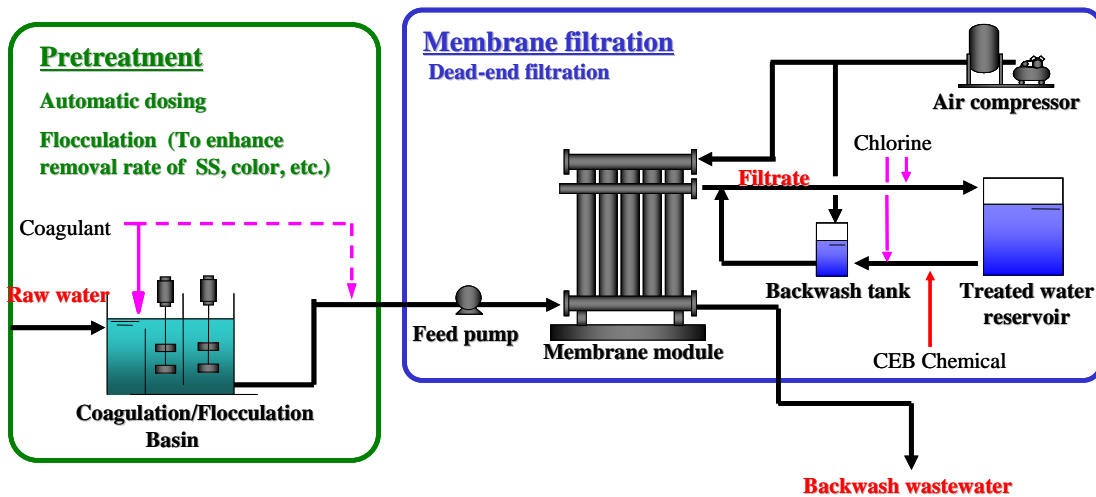

Ceramic Membrane Cleaning Process

- **Chemically Enhanced Backwash (CEB)**
 - Chemicals: H₂SO₄ (pH 2)
NaOCl (50-100 mg/L)
 - Intervals: 1-2 times/week, site specific

- **Clean In Place (CIP)**
 - Chemicals: NaOCl (3000 mg/L)
Citric Acid (1%)

- Intervals: 1-4 times/year, site specific

Status of Ceramic Membrane Outside of Japan

- Successful Pilot Studies Conducted in Southern California and North Carolina
- Granted CDPH Conditional Acceptance as Alternative Filtration Technology for 4-log Crypto, 4-log Giardia, and 1-log Virus Removal (at max. 200 gfd and 55 psi TMP)
- Successful Pilot Studies Conducted in Stockholm, Sweden and Mülheim, Germany
- Life Cycle Cost (20 years, 5%) Comparisons of 10 MI/d (2.5 mgd) and 50 MI/d (12.5 mgd) WTPs Indicated Cost Competitive with Polymeric Hollow Fiber Membranes
- Pilot Testing Conducted in Bakersfield by Cal Water Service Co. & B&V for a 20 mgd Plant
- One Plant is Being Constructed in Colorado

四、 國外以薄膜技術進行煉油廠水及廢水處理回收案例

UF/RO 已被公認為廢水經二級生物處理後進行回收處理的最佳技術，而執這一技術牛耳之一的乃是 GE/Zenon 公司，在這裡介紹該公司用於煉油石化廠水廢水處理回收及水處理方面的實例：

Industrial Refinery / Petrochemicals Water and Wastewater Treatment ZeeWeed Plant Installation
List - April 2009

REFINERY & PETROCHEMICALS - WASTEWATER

1.Taneco Refinery, Nizhnekamsk, Tatarstan, Russia

Type of System: ZeeWeed® MBR + EDR + RO

Flow Rate - Phase 1: 4,438,100 US gpd (16,800 m³/day)

Flow Rate - Phase 2: 8,876,200 US gpd (33,600 m³/day)

Flow Rate - Phase 3: 13,314,300 US gpd (50,400 m³/day)

Application: Refinery wastewater

Commissioned: TBC



2.REVAP Refinery (Petrobras), Brazil

Type of System: ZeeWeed® MBR

Flow Rate: 1,902,000 US gpd (7,200 m³/day)

Application: Refinery wastewater

Commissioned: TBC



3.Lukoil Volgograd Refinery, Russia

Type of System: ZeeWeed® MBR

Flow Rate: 3,962,600 US gpd (15,000 m³/day)

Application: Refinery wastewater

Commissioned: TBC



4.HPCL Refinery, India

Type of System: ZeeWeed® MBR

Flow Rate: 1,900,000 US gpd (7,200 m³/day)

Application: Refinery wastewater

Commissioned: April 2009

5.Bina Refinery, India

Type of System: ZeeWeed® MBR

Flow Rate: 2,400,000 US gpd (9,000 m³/day)

Application: Refinery wastewater

Commissioned: December 2008

6.Fox Petroli Spa Biodiesel, Italy

Type of System: ZeeWeed® MBR

Flow Rate: 12,680 US gpd (48 m³/day)

Application: Biodiesel wastewater

Commissioned: November 2007

7.Biodiesel Bionor, Spain

Type of System: ZeeWeed® MBR

Flow Rate: 39,600 US gpd (150 m³/day)

Application: Biodiesel wastewater

Commissioned: June 2007

8. Conoco Philips, Hull, UK

Type of System: ZeeWeed® tertiary treatment + reverse osmosis for reuse

Flow Rate: 3,800,000 US gpd (14,400 m³/day)

Application: Refinery wastewater reuse for CHP cooling tower makeup water (DB)

Commissioned: July 2007



9. ENI, Gela, Sicily

Type of System: ZeeWeed® MBR + reverse osmosis

Flow Rate: 1,900,000 US gpd (7,200 m³/day)

Application: Contaminated refinery groundwater treatment

Commissioned: March 2007



10. ENI Priolo, Sicily

Type of System: ZeeWeed® MBR + reverse osmosis

Flow Rate: 3,800,000 US gpd (14,400 m³/day)

Application: Contaminated refinery groundwater treatment

Commissioned: Q4 2009

11.Sasol Secunda, South Africa

Type of System: ZeeWeed® tertiary treatment + reverse osmosis for reuse

Flow Rate: 3,300,000 US gpd (12,500 m³/day)

Application: Cooling tower blowdown wastewater treatment for refinery reuse

Commissioned: January 2006



12.ENI R&M, Taranto, Italy

Type of System: ZeeWeed® tertiary treatment + reverse osmosis for reuse

Flow Rate: 3,500,000 US gpd (13,250 m³/day)

Application: Refinery wastewater treatment for industrial reuse

Commissioned: September 2006



13.Formosa Petrochemicals, Taiwan

Type of System: ZeeWeed® MBR + reverse osmosis for reuse

Flow Rate: Phase 1: 1,320,000 US gpd (5,000 m³/day)

Phase 2: 5,280,000 US gpd (19,990m³/day)

Application: Petrochemicals wastewater treatment for industrial reuse

Commissioned: March 2006



14.Syndial – Porto Marghera, Italy

Type of System: ZeeWeed® MBR

Flow Rate: 12,550,000 US gpd (47,500 m³/day)

Application: Petrochemicals wastewater treatment for discharge

Commissioned: November 2005



15.Beijing Yanshan Petrochemical, China

Type of System: ZeeWeed® tertiary treatment + reverse osmosis for reuse

Flow Rate: 6,815,640 US gpd (25,800 m³/day)

Application: Petrochemicals wastewater treatment for industrial reuse

Commissioned: July 2004



16. Borsodchem, Hungary

Type of System: ZeeWeed® MBR + reverse osmosis

Flow Rate: 158,500 US gpd (600 m³/day)

Application: Petrochemicals wastewater

Commissioned: May 2004

17. Syndial Manfredonia, Italy

Type of System: ZeeWeed® tertiary treatment

Flow Rate: 760,000 US gpd (2,880 m³/day)

Application: Petrochemicals wastewater

Commissioned: September 2006

18. Marathon Oil, KY, USA

Type of System: ZeeWeed® MBR

Flow Rate: 50,000 US gpd (190 m³/day)

Application: Oily wastewater from oil barge cleaning

Commissioned: July 2003



19.MOL Rt., Zalai Finomítóban (ZAFI) Plant, Hungary

Type of System: ZeeWeed® MBR

Flow Rate: 126,720 US gpd (480 m³/day)

Application: Refinery wastewater

Commissioned: November 2003



20.ExxonMobil Chemical, Panyu, China

Type of System: ZeeWeed® MBR

Flow Rate: 12,700 US gpd (48 m³/day)

Application: Petrochemicals wastewater

Commissioned: May 2001

21.PEMEX, Minatitlan, Mexico

Type of System: ZeeWeed® tertiary treatment + reverse osmosis for reuse

Flow Rate: 5,700,000 US gpd (21,600 m³/day) average day flow

6,912,000 US gpd (26,160 m³/day) maximum day flow

Application: Refinery and municipal wastewater treatment for refinery process reuse

Commissioned: November 2001

22.ExxonMobil Chemical, LA, USA

Type of System: Tubular Permaflow® MBR

Flow Rate: 40,000 US gpd (150 m³/day)

Application: Petrochemicals wastewater

Commissioned: September 2005

(二)REFINERY & PETROCHEMICALS – PROCESS WATER

1.Ferus Oil & Gas, Red Deer, AB

Type of System: ZeeWeed® UF + reverse osmosis

Flow Rate: 92,460 US gpd (350 m³/day)

Application: Boiler Feedwater pretreatment

Commissioned: June 2007

2.CNRL Horizon Oilsands Project, AB

Type of System: ZeeWeed® UF + reverse osmosis + mixed bed deionization

Flow Rate: 6,800,000 US gpd (25,740 m³/day)

Application: Boiler Feedwater pretreatment (Athabasca River)

Commissioned: December 2007



Petrobras REMAN, Manaus, Brazil

Type of System: ZeeWeed® UF + reverse osmosis

Flow Rate: 760,000 US gpd (2,880 m³/day)

Application: Boiler Feedwater pretreatment

Commissioned: February 2002



3. Petrobras REVAP, Sao Paolo, Brazil

Type of System: ZeeWeed® UF + reverse osmosis

Flow Rate: 1,340,000 US gpd (5,070 m³/day)

Application: Boiler Feedwater pretreatment

Commissioned: November 2003



4. Petrobras REDUC, Rio de Janeiro, Brazil

Type of System: ZeeWeed® UF + reverse osmosis

Flow Rate: 4,200,000 US gpd (15,900 m³/day)

Application: Boiler Feedwater pretreatment

Commissioned: June 2004



5. Borsodchem VCM I

Type of System: ZeeWeed® UF + reverse osmosis

Flow Rate: 101,400 US gpd (385 m³/day)

Application: Boiler Feedwater pretreatment

Commissioned: June 2001

6. Shell Albian Oilsands, Alberta

Type of System: Dual treatment (2 x 1,000 USgpm) ZeeWeed®

Ultrafiltration + single pass RO + softener polishing (all GE Water)

Flow Rate: 2,600,000 US gpd (9,800 m³/day)

Application: Boiler Feedwater pretreatment for a highly-variable surface water

Commissioned: February 2002

7. Shell Canada Scotford Plant (Shell Upgrader), Alberta

Type of System: Dual treatment (2 x 1,550 USgpm) ZeeWeed®

Ultrafiltration + single pass RO + MB polishing (all GE Water)

Flow Rate: 3,500,000 US gpd (13,250 m³/day)

Application: Boiler Feedwater pretreatment (North Saskatchewan River)

Commissioned: August 2001

8. Shell Chemicals Canada Scotford MEG Plant, Alberta

Type of System: Dual train (2 x 550 USgpm) ZeeWeed® ultrafiltration + single pass RO + MB polishing system

Flow Rate: 1,000,000 US gpd (3,785 m³/day)

Application: Boiler Feedwater pretreatment (North Saskatchewan River)

Commissioned: 1999

9. MOL Rt., Almásfüzitő Plant, Hungary

Type of System: ZeeWeed® UF + reverse osmosis

Flow Rate: 140,000 US gpd (530 m³/day)

Application: Boiler Feedwater pretreatment (Danube River water with high TSS)

Commissioned: 1999

10.EnCana Corporation (Alberta Energy Company)

Conwest AEC West Sexmith Gas Plant

Type of System: ZeeWeed® ultrafiltration + double pass reverse osmosis

Flow Rate: 105,670 US gpd (400 m³/day)

Application: Boiler Feedwater pretreatment of poor quality well water for boiler feedwater for a natural gas production plant.

Commissioned: 1997

五、 2009ACE 照片介紹

(此部份因檔案過大，導致無法上傳，故省略)

六、 WesTech 公司煉油廢水處理與回收技術

WesTech 工程公司成立於 1972 年，總部在美國猶他州鹽湖城，是一個服務項目包括：Water Treatment、Water Reclamation and Reuse、Wastewater Treatment、Power Generation、Food Process、Chemical and Pharmaceutical、Textile Production、Metals Production、Mining and Metallurgy、Pulp and Paper、Coal Preparation 等，是美國一家聲譽相當良好，全球性的工程公司。由於該公司在大林廠第三廢水工程中提供 CPI 油水分離器、溶氣加壓浮除(DAF)及終沉池刮泥馬達等設備，並且在廢水處理回收上有其獨到經驗，其所建議之處理回收方式內容廣泛詳細，在此僅扼要節錄：

1. 建議之煉油廢水處理流程如下

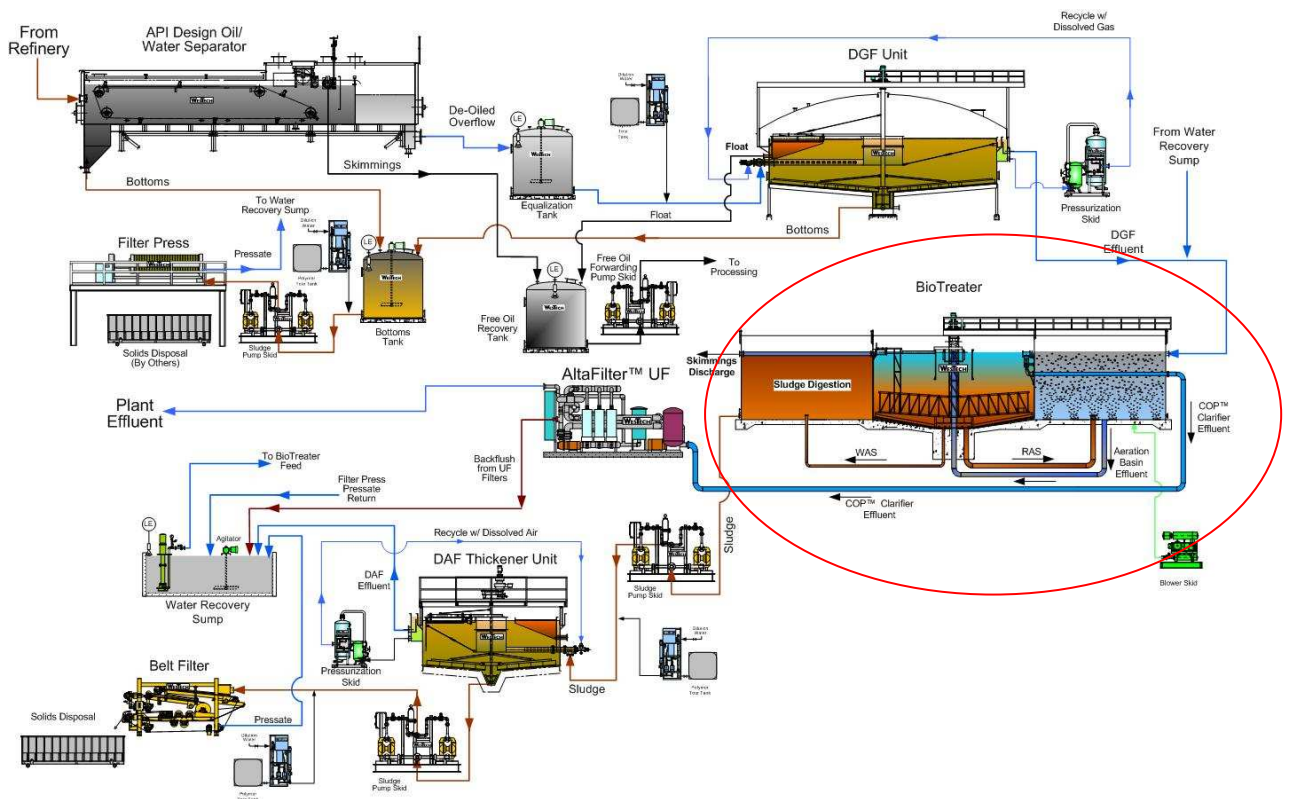

其獨特到的地方在於 Biotreator 俱有生物好氧、缺氧、加氧處理(為了控制污泥膨化, optional)、沉澱固液分離等功能, 佔地小, 所需動力少, 較節能。

2. CIRCULAR OIL WATER SEPARATOR

七、國內含油廢水薄膜處理回收情形

以下資料並不在這次研討會之內，但他山之石，可以攻錯，為了使煉油廠廢水回收技術之探討更加完整，故加以整理納入，以下簡述台塑、中美和、中鋼及本公司林園廠曾委託研究之案例：

(一) 台塑六輕節水及水回收

93 年台塑六輕設立之初，環評同意一至四期用水量 42.4 萬噸/日，但是要求 3 年內(一至三期)用水量要回復到 25.7 萬噸/日，95 年時因離島工業區用水重新分配，工業局要求六輕當第四期擴建完成後，用水量需降至 34.55 萬噸/日。在此壓力下六輕積極進行節水計畫，以下為其 88-99 年節水改善成效。(摘自六輕節水及水資源開發研討觀摩會 98.6)

表 7-1 台塑六輕歷年之節水努力

	項目	件數	節水量 (萬噸/日)	比率 (%)	改善說明
一	製程廢水減量	197	4.8	19.6	採用先進製程技術，不斷提昇設備效率，調整操作條件
二	廢水回收再利用	327	16.5	67.4	製程低污染廢水回收作為次級用水，增設廢水處理回收設備
三	降低蒸發損失	141	2.8	11.4	回收低壓蒸汽，以空冷機取代水冷式換熱器，冷卻水塔設擋風板
四	雨水收集利用	51	0.4	1.6	做好清污分流措施，增加槽區、屋頂及綠地之雨水收集面積
合計		716	24.5	100	

廢水回收再利用之案例：

1. 台塑塑膠公司 PVC 廠製程廢水處理後之放流水，回收當製程沖洗及補充用水，回收 2,370 噸/日。台塑找 A.凱膜(UF+RO+MBF，處理成本 20 元/噸)B.環琦(CoIOX+ACF+UF+RO+MBF，處理成本 19 元/噸)C.奇異(Jelcleer 精密自動逆洗過濾，處理成本 5.1 元/噸)三家公司進行 Pilot Plant 評估，最後選擇奇異公司的技術。
2. 麥寮及海豐廢水處理場放流水處理回收 600 噸/日及冷卻逆洗廢水處理後之放流水。(1)製程廢水處理後之放流水回收評估：A.工研院(MF+UF+RO，處理成本 48

- 元/噸)B.Hyflux(UF+RO，處理成本 43 元/噸)。本案尚未完成評估。(2)冷卻逆洗廢水處理後之放流水回收評估：A.Toray(DMF+PF+RO，處理成本 23.6 元/噸)B.鑫雅(EDR，處理成本 15.1 元/噸)C.堡辰(袋式過濾+濾心過濾+活性炭+預過濾，處理成本 23.1 元/噸)。本案尚未完成評估。
3. 台化公司 PTA 廢水處理回收：PTA 廠純化廢水經中和、調合、厭氧處理後，再使用 MBR+RO 處理，回收 7200 噸/日到製程，回收率約 8 成，出水 EC<10us/cm、COD<50mg/L，處理費用 17.0 元/噸，總投資費用 4 億 6 仟萬，預計 99 年 6 月完工。
 4. 冷卻水塔排放水處理回收：入水導電度 3500us/cm，鈣硬度 1200mg/L，SiO₂ 60mg/L，進水量 50 噸/日，使用 UF(ZeeWeed 沉浸式中空纖維膜)+RO 系統，回收量 564 噸/日，導電度 <250us/cm，鈣硬度<50mg/L，SiO₂<10mg/L。
 5. 海水淡化：投資 8613 萬元設二套 250 噸/日之海水淡化試驗機組。一套採用化學混凝+雙介質過濾(DMF)+RO 做為預處理，另一套採用 UF+RO。97.06 開始測試，進水為六輕發電廠排放水，海水鹽度 30.1-35.8psu，SS 為 9.2-70.8mg/L，硼 3.52mg/L。測試結果：UF 易受到海水濁度變化的影響，化學混凝+雙介質過濾出水比較穩定，可使 SDI 小於管制值 3。RO 出水 pH=6-9，導電度<20us/cm，除硼偏高(平均 1.63mg/L，WHO 建議<0.5mg/L)外，可符合自來水標準。

(二)中美和廢水處理回收

中美和 PTA 製程廢水及冷卻水塔排水合計約 9,000CMD，經處理後，回收率 74%，亦即約 6,600CMD。圖一為廢水處理回收方塊流程圖，圖二為廢水處理回收系統與水供應系統關係圖。廠內 PTA 廢水經有機廢水處理系統(Organic Wastewater Treatment System, OWWTS)後放流水，與冷卻水塔排放水混合，先經次氯酸鈉氧化、雙濾料塔過濾、活性炭吸附、再過濾、UF、UV、RO、脫氣，導電度<200 uS/cm，回收進入超純水製造系統，做成超純水。總投資美金 1 仟 5 佰萬元，一年操作維護費美金 2.5 佰萬，估計一年節省水及廢水處理費約美金 8 佰萬，相減後一年淨節省美金 5.5 佰萬。主要原因在於回收水導電度低(<250us/cm)，而原水導電度 750us/cm，因此可以大幅減少後續離子交換樹脂的再生頻率，減少再生藥劑的使用及排放廢液的處理費。水回收 O&M 費用為美金 1.04/M³(2,500,000 美元/(365*6,600M³))，約新台幣

34 元/m³。表一至三為水質分析及 UF/RO 回收率。

表一 冷卻水塔排放水及 OWWTS 放流水水質分析

分析項目	冷卻水塔排放水	OWWTS 放流水	放流標準
pH	7.32	8.46	6 – 9
TSS, mg/L	10	24	30
T-H, mg/L as CaCO ₃	980	39	-
TDS, mg/L	1,430	3,544	-
Cond, us/cm	3,690	4,260	-
SiO ₂ , mg/L	71.6	3.5	-
COD, mg/L	51	74	100
Co, mg/L	-	2.2	-
Mn, mg/L	-	1.3	10

表二 UF/RO 模廠回收水平均水質

分析項目	數值
Cond. us/cm	<240
硬度, mg/L as CaCO ₃	<5
SiO ₂ , mg/L	<2
pH	6.9
CO ₂ , mg/L	5
Mn, mg/L	Trace
Co, mg/L	Trace
COD, mg/L	Trace

表三 平均回收率

UF	92%
RO	80%
UF/RO	73.6%

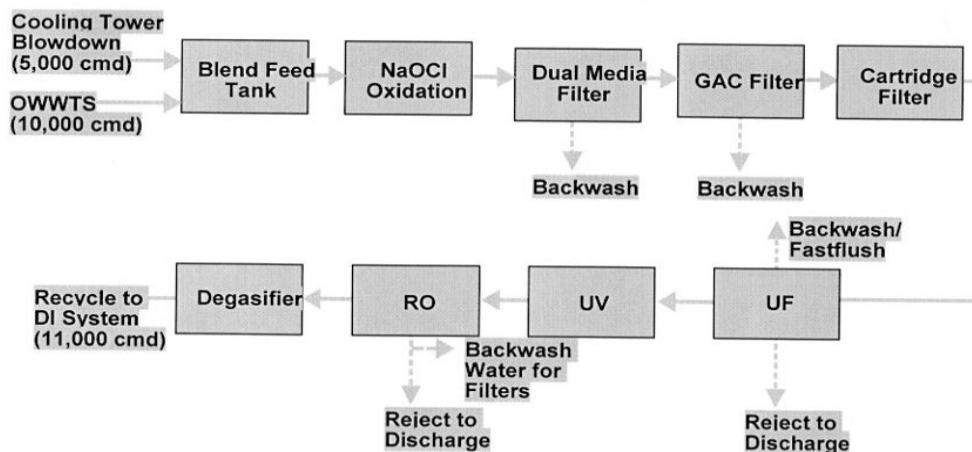

圖一 中美和廢水處理回收方塊流程圖

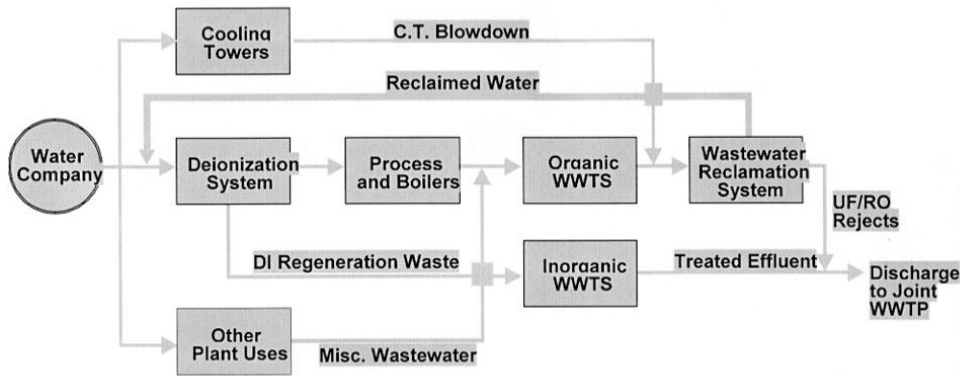

圖二 中美和廢水處理回收系統與水供應系統關係圖

(三)中鋼廢水回收興建計畫

中鋼公司目前每日用水量 16 萬噸，放流量 4.8 萬噸。處理水量 2.8 萬噸/日，處理程序 UF+RO，產製純水 9,000 噸/日；處理程序 UF+RO+IE，產製純水 4,500 噸/日，純水+超純水合計回收量 13,500 噸/日。全部工程於 98.08 完成試俾開始投產，投資費用：機械土木約 4 億 5500 萬+儀電約 1.3 億+加中鋼供料約 2.6 億=8 億 4500 萬，建造單價約 6.26 萬元/噸水，使用 10 年，設備折舊費 8,450 萬元/年，即 17.1 元/噸水，操作費 15 元/噸水，合計處理成本(含設備折舊)17.1 + 15 = 32.1 元/噸。

Pilot Test 各階段產水水質分析如下：

項目, 單位	放流水	UF+RO	UF+RO+IE	STD
Cond, us/cm	3899	103	0.009	<0.02
pH	8	7	7.3	6-8
COD, mg/L	38	10	-	
Ca, mg/L	173	2	-	<10
Mg, mg/L	29	0	-	
Na, mg/L	421	14	0.0015	<0.005
M-A, mg/L	311	16	-	
SO4, mg/L	474	8	-	
Cl, mg/L	796	19	-	
SiO2, mg/L	15	0.2	0.00266	<0.005

(四)本公司林園廠廢水處理回收

1. 中宇評估報告(96.6-96.12)

針對冷卻水塔排水及廢水處理場放流水進行回收處理評估。

廢水處理場放流水採用處理程序為生物濾床+活性碳砂濾+RO。其各單元之水質分析如下：

項目, 單位	廢水處理場放流水	生物濾床出水	活性碳砂濾出水	RO 產水
Cond., us/cm	3785-4125	-	-	77-88
pH	7.1-7.5	-	7.6-7.8	6.9-7.1
COD, mg/L	27-41	31-34	-	-

冷卻水塔排水採用處理程序為結晶軟化床+RO。其各單元之水質分析如下：

項目, 單位	冷卻水塔排水	結晶軟化床出水	RO 進水	RO 產水
Cond., us/cm	2736-3012	3767-4023	1233-5434	12.8-155
pH	6.01	8.9	-	-
Ca, mg/L	213-1475	146-977	-	-
總硬度, mg/L as CaCO ₃	261-1980	154-955	-	-
SiO ₂ , mg/L	12.7-98.9	0.38-36.7	-	-
操作壓力, Kg/cm ²			10.5-15.6	9.9-14.1

經過 RO 處理，脫鹽率可達 96% 以上，RO 產水率約 50-60%。

2.京華公司評估報告

總排放水回收處理程序：纖維過濾+UF+RO

對濁度去除率：纖維過濾 88-93%，UF87-88%

項目, 單位	總排放水	纖維過濾出水	UF 出水	RO 出水
Cond., us/cm	-	-	8000-12000*	50-110*
濁度, NTU	3.26-5.38	0.33-0.37	0.04-0.05	-
Ca 硬度, mg/L as CaCO ₃	-	-	-	ND
SiO ₂ , mg/L	-	-	-	0.55-2.05
總硬度, mg/L as CaCO ₃	-	-	-	1-2
M-A(鹼度), mg/L	-	-	-	5.4-16.3
TS, mg/L	-	-	-	14-63
Fe ²⁺ , mg/L	-	-	-	<0.02
SO ₄ , mg/L	-	-	-	0.44-0.63
Cl, mg/L	-	-	-	4.20-21.43
Na, mg/L	-	-	-	7-34

*當產水率為 60%時。

若以處理量 5,500 噸/日，回收量 3,850 噸/日，回收率 70%計算，總建造費 6 仟 7 佰萬，建造單價約 1.74 萬元/噸水，使用 10 年，設備折舊費 670 萬元/年，即 4.87 元/噸水，操作費 15 元/噸水，合計處理成本(含設備折舊)4.87 + 15 ÷ 20 元/噸。

八、心得與建議

1. 沉浸式中空纖維超過濾膜(Submerged Hollow Fiber UF Membrane)單元所需要的設備土地面積，僅有傳統混凝沉澱單元的 1/3 - 1/5，同時可以節省後者所需要的化學藥劑及廢棄污泥處理費，相當有競爭性。雙椽谷水處理場因使用沉浸式中空纖維超過濾膜，產生極少的污泥，這些污泥經脫水後，當沖洗及澆灌草坪用，幾乎達到零排放。
2. 本公司目前桃園煉油廠向石門水庫買原水回來後，皆經過化學混凝沉澱，去除懸浮固體(SS)後再進一步處理成生活用水、純水及超純水。未來可評估採用沉浸式中空纖維超過濾膜，以增加土地利用價值。或是現有方法配合超過濾膜，在原木濁度增加時，快速去除 SS，使出水可以達到標準。
3. 國內各自來水廠目前也都僅採用傳統的混凝沉澱法做原水的前處理，還沒有使用沉浸式超過濾膜處理。但是根據水質的狀況，會採用不同的處理措施，如鳳山水庫因高屏溪水值硬度較高，該處理程序多一道結晶軟化處理，用以去除硬度，此外，為了去除味道及微量有機物，鳳山水庫處理程也有臭氧反應及生物活性碳反應槽。
4. 生物活性碳處理已漸普遍用於自來水水場，其包含三種反應機制，即活性碳吸附、生物膜之生物分解作用及活性碳生物再生作用。活性碳單位重量表面積愈大，吸附有機物能力愈大；活性碳表面的粗糙度愈高，使微生物愈容易附著，提高有機物的去除效率。
5. 美國自來水可以生飲，但是為了確保水質不滋生細菌，出廠的自來水仍不可避免地添加氯氣，(氯氣是由氯與氫所組成的化合物，與氯比較它是較弱的氧化劑，因此產生較少量的消毒副產品，但是比氯有較長時間的殺菌能力)，因此，美國家庭在飲用自來水前，先經活性碳吸附也逐漸普遍。
6. 加州聖地亞哥 90%以上的水來自別的區域，自有水源不到 10%，因其水資源極缺乏的特殊性，因此積極進行水回收計畫，自 1990 後回收再利用為廢水處理的設計的準則。對於名稱也都由原先之廢污水處理場改稱為水回收場，如本文介紹的設於 2002 年的南灣水回收場(South Bay Water Reclamation Plant, SBWRP)及先前提到的設於 1997 年，處理量 30MGD 的市北水回收場(North City Water Reclamation Plant, NCWRP)皆是如此。
7. 南灣水回收場雖然位於美墨邊界，離住宅區都有很長一段距離，但是對於廢污水

臭氣的處理卻很完善，攔污柵、曝氣沙礫去除槽、初沉池及曝氣池等單元皆採密閉處理，抽出的臭氣經次氯酸鈉淋洗，以去除硫化氫等臭味來源，全區的空氣幾乎沒有甚麼臭味。

8. 加州聖地牙哥地區自來水價每 100ft³(=2.8M³)約美金 2 元，即新台幣 66 元左右。回收水價格約為一半，即美金 1 元，這是已補貼後的價格，換算成新台幣每立方米(即每噸，每度)自來水約 23.6 元，回收水 11.8 元。目前回收水使用大多為高爾夫球場、公園、高速公路旁、學校..等，用於澆灌綠地，在舊金山地區一些新大樓甚至已經規定要用到廁所沖洗。為安全起見，回收水管線一律使用紫色，以明顯區分。
9. 在台灣自來水水價 1 噸約 12 元，過去 10 年來曾有調高水價的計畫，但因牽涉廣泛而一直未實施。為了節約水資源，政府這幾年也在倡導生活污水回收再利用，並已在一些新設院校、社區、公共設施..使用，回收量在 2008 年達到約 16,000CMD。未來也會將執行面擴及產業界及農業。以台中福田污水處理廠為例，計畫放流水供應台中港某鋼鐵廠做冷卻水塔，供應量 58,000CMD，已依環評承諾定案，可為台中地區之供水緩和 2,000 萬噸/年，廠商只需付回收水價 6 元/噸，輸送距離 27Km，管線工程政府負責。
10. 南灣水回收場化驗室線上隨時監控水質，確保所有處理程序保持正常，並將分析數據及各單元狀況立即顯示銀幕。值得一題的是，控制中心並無傳統之流程圖面板，而是以電腦連接置於銀幕後之投影機投射所有監控訊息及流程。這有極大地好處：初設費低、維護容易、不必因處理單元改變而就要動到整個面板、隨時可能投設任何資料在大銀幕上..等。本公司各現場目前還沒有使用，未來建議可朝此方向改善，可使工作更有效率並節省大筆經費。
11. 薄膜處理技術是 21 世紀進行水及廢水處理的主流趨勢，尤其是做為 RO 前處理的低壓薄膜處理技術—MF/UF，過去 12 年隨著科技的進步，全球 MF/UF 處理量從 1998 年的 500MGD 達到如今超過 4,000MGD。MF/UF 在水及廢水處理上被證實可以提高處理的效果，同時降低了處理及土地成本。
12. 廢水與水資源僅一念之間，或許未來公司各廢水處理場可改名稱為水回收場，以宣示在本公司對於環保的重視及對水資源的珍惜。煉油廠可以回收的水資源包括最大宗之廢水處理場排放水、冷卻水塔排水、鍋爐排水、冷凝水及雨水..等。以往曾對前三者做過回收處理的研究，後因水價及回收成本仍有一段差距，而未付諸

實行。將來皆可以逐步來進行。

13. 由上述世界各國及國內廢水處理回收的案例來看，二級生物處理後之放流水以 UF+RO 處理為公認較好之回收處理組合。UF 可採用沉浸式(submerged)或是外掛式(Pressure)，一般而言，外掛式 UF 維護較方便，但是當處理量大於 10MGD 時採用沉浸式 UF 比較經濟。UF 供應商中又以 GE/Zenon、Siemens/Memcor 及 Pall(Asahi)之中空纖維膜(Hollow-Fiber MF/UF Membranes) 有較不錯的評價。唯畢竟各種廢水品質差異性很大，同業的煉油石化廢水也是如此，因此先進行模廠的試驗評估，仍是不可少的步驟。
14. 本公司要進行廢水回收，各煉油石化廠現有處理系統效率之正常發揮甚至效能提升是相當重要的，不能只寄望增加 UF+RO 單元就可解決一切問題。在未來實施水回收前，現場之管理及設施改善仍必須繼續進行，如源頭減廢及廢水分流規劃..等，以降低處理成本及達到事半功倍的效果。
15. 目前台灣自來水費約 12 元/m³，大林廠廢水自己處理完後送聯合污水處理場，平均每噸廢水需繳費 9.8 元(按照 COD、SS..等總量計算)；高廠廢水經加壓站海放，平均每噸廢水繳費 3.4 元(只以水量計)。故僅以經濟效益比較，大林廠水回收成本(與購入之自來水同樣水質)要低於 21.8 元(=12 + 9.8)；而高廠要低於 15.4 元(=12 + 3.4)才划算。本公司要做水回收，以不同環保公司的案例推估，合理建造單價約 6.5 萬元/噸水(產水)，處理成本介於 30-35 元/m³ (含設備折舊)，出水可做為超純水系統進料水。但詳細仍要經 Pilot Test 才能計算。
16. 除了上述外，也有諸多從用水網絡規劃達到節水目標的方法，如 1994 年由 Robin Smith 及 Y.P. Wang 所提出圖解法優化用水網絡 -- 水夾點(Water Pinch)分析法。及近來針對本方法之不足，而將水夾點分析與數學規劃法結合進行用水網絡設計，這些都值得進一步去探討。
17. 以上敘述一些技術曾面的問題，但最重要的是要從觀念上做到：
「清潔生產重於源頭減廢」、「源頭減廢重於管末處理」及「節水重於水回收再利用」。由製程的改善做起，減少廢氣、廢棄物及廢水的產生，每個製程用水合理化以節約用水，才能產生最大的效益。

九、附件

(一) AWWA 2009ACE 內容



Track	Monday, June 15				Tuesday, June 16			Wednesday, June 17			Thursday, June 18		
	9-10 a.m.	noon-2:45 p.m.	1-1:45 p.m.	2-5 p.m. (6 papers)	8-8:45 a.m.	9 a.m.-noon (6 papers)	2-5 p.m. (6 papers)	8-9:30 a.m.	9:45 a.m.-12:15 p.m. (5 papers)	2-5 p.m. (6 papers)	9 a.m.-noon (6 papers)		
DISTRIBUTION & PLANT OPERATIONS Page 6 Earn CEUs	Opening General Session	AEDSP Session	Monday Keynote Address	Water Treatment Plant Operations—Optimization and Maintenance	Tuesday Keynote Address	Challenges in Water Loss Control	Advances in Metering	H ₂ Open Forum	Distribution System Operating Challenges and Solutions	Water Treatment Plant Operations—Focusing on Membrane Processes	Water Main Rehabilitation: Lessons Learned and New Approaches		
				Strategies for Better Energy Management			Water Treatment Plant Operations—Clarification Technologies, Engineering and Operations Perspective			How Cross-Connection Control Programs Protect Distribution Water Quality			
ENGINEERING & CONSTRUCTION Page 6						Water System Modeling and Planning Applications			Green Energy Production and Recovery		Sustainable and Innovative Approaches to Infrastructure Management	Alternative Water Supply Planning and Design	Extreme Engineering—Facing Big Challenges in Planning and Design of Treatment Plants
EXECUTIVE Page 7						Water Sector Workforce Sustainability Initiative			Technology to Support Workforce Development Initiatives		Building Communities Through Diversity	Training Our Utility Managers Now! A Priority, Not an Option	
INTERNATIONAL Page 7									International Funding of Water & Sanitation Projects		Water on the Worldwide Political Agenda—Part 1	Water on the Worldwide Political Agenda—Part II	Integrated Basin Management—Global Case Studies
LEGISLATIVE & REGULATORY Page 7			Climate Change and Water		Federal Regulatory Update		Quagga Mussels	Regulatory Challenges for Implementing Desalination Facilities	Technical Solutions to Regulatory Problems				

preliminary professional sessions schedule

Track	Monday, June 15			Tuesday, June 16			Wednesday, June 17			Thursday, June 18	
	9-10 a.m.	noon-2:45 p.m.	1-1:45 p.m.	2-5 p.m. (6 papers)	8-8:45 a.m.	9 a.m.-noon (6 papers)	2-5 p.m. (6 papers)	8-9:30 a.m.	9:45 a.m.-12:15 p.m. (5 papers)	2-5 p.m. (6 papers)	9 a.m.-noon (6 papers)
MANAGEMENT Page 7	Opening General Session	AESFP Session	Monday Keynote Address	Show Me the Money in a Down Economy	Tuesday Keynote Address	Responding to Evolving Challenges and Needs—Strategic Management Practices that Provide a Foundation for Action	Strategic Financial Planning—The Utility's Road Map to Financial Health	H2O Open Forum	Workforce Development: A Collaborative Approach to Filling the Pipeline	Attracting and Retaining Tomorrow's Workforce: Programs You Can Use	Seeking Regional Solutions that Support Organizational Performance and Sound Financial Strategies
						The Grapes of Wrath: Water Pricing and Affordability in Hard Times	Local Case Studies and Other Recent Initiatives in Water Systems Security and Preparedness				The Promise of Efficient Customer Service
MANUFACTURERS/ASSOCIATES Page 8 Earn CEUs				Treatment of Emerging Contaminants		Green Initiatives in the Water Works Industry			Preventive Maintenance on Distribution Systems		
PUBLIC AFFAIRS & PUBLIC INTEREST ADVISORY FORUM Page 8				Implementing Crisis and Risk Communications Campaigns		Utilizing Viral and Social Media in Communications Campaigns			Community-Based and Grassroots Communications Campaigns		
RESEARCH Page 8				Controversial Issues in Health Effects Research		Emerging Issues in Membrane & Treatment Technology	Implications and Approaches of Corrosion Control		Plant Operations Research	Particle Characterization and Treatment Optimization: New Developments and Applications	Climatological and Environmental Impacts of Disinfection By-product Formation
RESIDUALS Page 8 Earn CEUs							Residuals Challenges		Inorganic Contaminant Research: Recent Advances in California and the West		Water Research: Source to Tap
				Desalination Membrane Residuals							

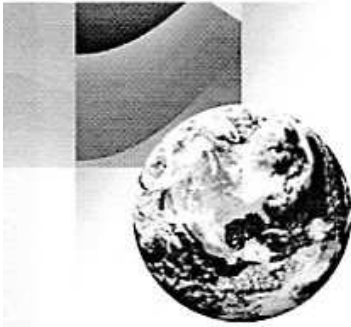

announcement

Track	Monday, June 15				Tuesday, June 16			Wednesday, June 17			Thursday, June 18		
	9-10 a.m.	10:01-2:45 p.m.	1-1:45 p.m.	2-5 p.m. (6 papers)	8-8:45 a.m.	9 a.m. - noon (6 papers)	2-5 p.m. (6 papers)	8-9:30 a.m.	9:45-12:15 p.m. (5 papers)	2-5 p.m. (6 papers)	9 a.m. - noon (6 papers)		
REUSE Page 9 Earn CEUs	OCS Opening General Session	AESP Sidebar	Monday Keynote Address		Tuesday Keynote Address	Exploring Key Factors in the Design of Water Reuse Facilities		H2Open Forum	Innovative Strategies in Water Reuse Implementation	The Water Reuse/ Groundwater Interface—Groundwater Recharge			
SMALL SYSTEMS Page 9 Earn CEUs				Asset Protection and Improvement—Capital and Human		Small Systems Treatment I	Small Systems Treatment II		Regional Approaches and Strategies: Capacity and Workforce Issues	Technical, Managerial, and Financial Issues for Small Systems			
SPECIAL TOPICS Page 9				State of the Industry Report		Water Research Foundation: Potential Groundwater Impacts from Geological Carbon Sequestration	Water Sustainability (Sponsored by the Canadian Affairs Comm.)		Volunteering in the International Field: The World Water Corps Bring Home the Data	Western Regional Water Issues	Young Professionals: Water Operations and Advances	International Case Studies in EcoSanitation: Water For People Programs in South America and Africa	Drought—What Did You Do and What Worked?
UNIVERSITIES FORUM Page 9				Universities Forum I		Universities Forum II	Universities Forum III						
WATER CONSERVATION Page 9				Challenges and Approaches to Reducing Outdoor Water Use			Measures for Water Conservation			Working Together to Save Resources & Maximize Co-Benefits	Water Conservation Rates and Water Loss Control		

Track	Monday, June 15				Tuesday, June 16			Wednesday, June 17			Thursday, June 18
	9-10 a.m.	noon-12:45 p.m.	1-1:45 p.m.	2-5 p.m. (6 papers)	8-8:45 a.m.	9 a.m.-noon (8 papers)	2-5 p.m. (5 papers)	8-9:30 a.m.	9:45 a.m.-12:15 p.m. (5 papers)	2-5 p.m. (6 papers)	8 a.m.-noon (8 papers)
WATER QUALITY Page 9 Earn CEUs	OCS Opening General Session	AEESE Session	Monday Keynote Address	Membrane Treatment: Regulatory, Low Pressure, High Pressure, and De-aeration	Tuesday Keynote Address	USEPA's Four Lab Study: Integrated Assessment of Complex Disinfection By-product Mixtures	H ₂ Open Forum	Taste and Odor Control That Knocks Your Socks Off!	Nitrogenous DBPs and Bromate	Understanding Water Quality Impacts on Corrosion Control	Membrane Treatment: Regulatory, Low Pressure, High Pressure, and De-aeration
				Organics—Traditional to Exotic		Impact of Inorganics on Taste and Odor		Environmental Impacts of Drinking Water Utility Activities		Distribution System Optimization Programs and Tools	
WATER RESOURCES Page 10				Groundwater		Implementing Ocean Desalination		Integrated Resource Planning		Climate Change and Water Resource Planning	Water Resource Planning in California
POSTER SESSIONS Page 10				Monday Afternoon Poster Session		"Fresh Ideas" Poster Session		Wednesday Morning Poster Session		Wednesday Afternoon Poster Session	
						Source Water Protection					
						Making Efficient Use of Saline Water					

(二) AWWA 2009ACE 參展廠商

Exhibitors



Exhibitor	Booth	Exhibitor	Booth
Cogsdale Corp.	3105	Ditch Witch of California	912
Columbian TecTank	801	Doosan Hydro Technology.....	1749
Concord Screen	2650	Dow Chemical Co. (The).....	3151
Contazara SA	1237	Dresser Manufacturing Div. , Dresser Industries	3328
Continental Utility Solutions Inc.	2346	Droycon Bioconcepts Inc.	3140
Control Microsystems.....	2835	DYK Inc.	1838
Con-V-Air.....	3241		
CORE International LLC	1117	EA Services	237
Corpro Companies Inc.	2828	Eagle Microsystems.....	2247
Covercat	3629	Early Warning Inc.	2947
Crispin-Multiplex Manufacturing Co.	721	Earth Science Laboratories	508
Croker Div. Fire-End and Croker Corp.	3305	East Jordan Iron Works Inc.	1100
Crom Corp. (The).....	712	EBAA Iron Inc.	2719
Crystal Engineering	1602	Echologics Engineering Inc	309
CUES	710	E.H. Wachs, E.H. Wachs Co.	2529
		Eka Chemicals.....	1406
Danfoss Flomatic Corp.	641	Electrolytic Technologies Corp.....	707
Data West Corp.	2338	Electrosteel USA.....	2832
Datamatic Ltd.	948	Elster AMCO Water Inc.	1449
Degremont Technologies	1319	EMA Inc.	2342
Delta Cooling Towers Inc.	1241	EMEC Americas Ltd.	2451
Denso.....	2951	Emerson Process Management	3528
Derceto Inc.	3610	Endress & Hauser Inc.	2546
DHI Water & Environment	2449	Engineered Storage Products Co.	1129
Diamond Plastics Corp.	3309	Engineering Ministries International.....	3416
		Environmental Science & Engineering	1649
		EP Minerals LLC	1046
		EPA Technical Assistance Center	3239
		ESRI Environ. Systems Research Inst.	2337
		Farwest Corrosion Control Co.	936
		Fiber Technology Corp.	1647
		Fibrwrap Construction Inc.	2651
		Fisher Research Laboratory	1229
		Floran Technologies Inc.	2813
		Floyd S. Salser Jr. & Assoc.	2521
		Fluid Conservation Systems.....	841
		Fluid Imaging Technologies Inc.	1446
		Fluid Metering Inc.	947
		Force Flow Equipment.....	2641
		Ford Meter Box Co. Inc. (The).....	1521
		Forrest T. Jones & Company Inc.	613



ACEO 9

SAN DIEGO

Exhibitors

Exhibitor	Booth	Exhibitor	Booth
Fouress Engineering (India) Ltd.	615	High Country Fusion Co.	337
F.S. Brainard & Co.	2634	Hirschmann Automation and Control Inc.	951
Fuji Electric Corp. of America	2841	HK Valve	1005
Fusion Tanks & Silos	2238	Hobas Pipe USA	1846
Galaxy Plastics Ltd.	3435	Home Fire Sprinkler Coalition	3207
Gallagher Security USA Inc.	120	HOT BOX/CDR Systems Group	3233
GBA Master Series Inc.	2815	Huayuan Water Purifying Technology Co. Ltd.	315
GE Analytical Instruments	2914	Hungerford & Terry Inc.	3444
GE Water & Process Technologies	2914	Hurco Technologies Inc.	128
Gebr. Heyl Analysentechnik GmbH & Co. KG	2950	Huwa International Pipeline Products BV	849
GE-MDS	2936	Hydranautics—A Nitto Denko Co.	411
General Chemical Corp.	1231	Hydra-Shield Mfg. Inc.	728
Geomembrane Technologies Inc.	2246	Hydra-Stop	209
GeoNav Group International	813	Hydro Gate	2129
Georg Fischer Central Plastics LLC	328	Hydro-Dyne Engineering Inc.	1012
Georg Fischer Signet	1946	Hydro-Guard (Enviro Enhancement & Tech)	1312
GFS Chemicals	414	ICI Paints	621
GL Industrial Services	2347	I dex Corp.	209
Global Pumps & Equipment	114	IDEXX Laboratories Inc.	3205
Global Water Instrumentation Inc.	1748	Idro Gas Engineering Europa S. N. C.	741
Golden State Water Co.	3142	I. Kruger Inc.	1135
Goodman Ball Inc.	305	Independent Pipe Products	433
<i>Government Engineering Journal</i>	3442		
Grand Haven Meter Coupling Sales	617		
Great Plains Industries Inc.	3332		
Griffin Pipe Products Co.	1101		
Gutermann Leak Detection	3145		
H2O Innovation (2000) Inc.	1729		
Hach Co.	1928, 1929		
Halogen Valve Systems Inc.	222		
Handheld	1336		
Hanna Instruments	3230		
Hansen Supply Co.	913		
Hanson Pressure Pipe Inc.	2829		
Harmsco Inc.	3613		
Harris Computer Systems	1115		
Healy Ruff Co.	3404		
Heath Consultants Inc.	1710		
Hersey Meters, Div. of Mueller Co.	918		
HF scientific inc.	729		

