

行政院所屬各機關出國報告  
(出國類別：考察)

## 赴歐考察精密光學製造與檢測技術發展趨勢 出國報告

服務機關：行政院國家科學委員會精密儀器發展中心

出國人：

姓 名	職 稱
王 必 昌	副 研 究 員

出國地區：德國、法國

出國期間：中華民國九十二年十月十三日至十月二十四日

報告日期：中華民國九十二年十二月十六日

40/CO9204091

系統識別號:C09204091

公務出國報告提要

頁數: 36 含附件: 是

報告名稱:

赴歐考察精密光學製造與檢測技術發展趨勢

主辦機關:

行政院國家科學委員會精密儀器發展中心

聯絡人/電話:

劉恭霖/03-5779911-522

出國人員:

王必昌 行政院國家科學委員會精密儀器發展中心 製造修護組 副研究員

出國類別: 考察

出國地區: 法國 德國

出國期間: 民國 92 年 10 月 13 日 - 民國 92 年 10 月 24 日

報告日期: 民國 92 年 12 月 16 日

分類號/目: G0/綜合(各類工程) G0/綜合(各類工程)

關鍵詞: 光學檢測技術;光學元件製作;Autocollimator

內容摘要: 精密儀器發展中心以累積多年之光、機、電及儀器整合技術之基礎，配合政策選定光學遙測技術為長期發展主軸之一，目標在於光學遙測儀器自主研發與整測能力的建立。因此為提升本中心光學檢測與製作技術，並掌握國際精密光學儀器發展趨勢，遂赴德、法等國相關產業機構考察光機製造檢測技術發展現況，並赴法參加在巴黎舉行的光電展，以蒐集相關光電產品與技術的發展訊息為建立中心光機系統組裝與檢測技術，本年度採購「偏位分析與組裝系統」檢測設備的先前驗收工作與原廠訓練，也是本次行程重要工作之一，該系統已順利安裝並移交中心使用；而與原廠工程師的討論，除增進量測原理的了解外，更有助於交流管道的建立。光電展資料的取得，可以充分了解目前國際光電技術與發展的趨勢，有些更有助於遙測計畫的需求，也可提供光學製造技術發展重要的參考資料。

本文電子檔已上傳至出國報告資訊網

## 目 錄

摘要 .....	3
壹、前言 .....	4
貳、目的 .....	6
參、過程 .....	9
肆、達成任務 .....	32
伍、心得與建議 .....	34
陸、附錄 .....	36

## 摘 要

精密儀器發展中心以累積多年之光、機、電及儀器整合技術之基礎，配合政策選定光學遙測技術為長期發展主軸之一，目標在於光學遙測儀器自主研發與整測能力的建立。因此為提升本中心光學檢測與製作技術，並掌握國際精密光學儀器發展趨勢，遂赴德、法等國相關產業機構考察光機製造檢測技術發展現況，並赴法參加在巴黎舉行的光電展，以蒐集相關光電產品與技術的發展訊息

為建立中心光機系統組裝與檢測技術，本年度採購「偏位分析與組裝系統」檢測設備的先前驗收工作與原廠訓練，也是本次行程重要工作之一，該系統已順利安裝並移交中心使用；而與原廠工程師的討論，除增進量測原理的了解外，更有助於交流管道的建立。

光電展資料的取得，可以充分了解目前國際光電技術與發展的趨勢，有些更有助於遙測計畫的需求，也可提供光學製造技術發展重要的參考資料。

## 壹、前言

光電產業為我國繼半導體產業後另一高科技、高成長產業，在相關產品如數位相機、光碟機、投影機等技術的不斷精進下，帶動了相關光學元件需求的快速成長，連帶使得台灣精密光學產業蓬勃發展；根據光電協進會 PIDA 的預估，未來幾年之精密光學元件市場需求值高於產值，所以國內精密光學元件廠商的未來幾年獲利成長性相當看好。而目前光電儀器或產品的研發已朝向輕、薄、短、小的概念發展，包含非球面光學元件的製造技術等。因此，即時掌握儀器技術的發展現況，將是帶動國內相關研究與技術發展之重要關鍵。

精密儀器發展中心以累積多年之光、機、電及儀器整合技術為基礎，配合產學研各界的需求，擇定光學遙測技術、微系統技術為長期發展項目。目前光學遙測計畫中規劃長期目標為高解析度光電遙測酬載(Remote Sensing Payload)的研製，目標在於自主研發與整測能力的建立，其中關鍵技術之一即為精密光學元件的製造與檢測包括非球面製造檢測技術。

而迄至目前為止德、法、美、日等國有較完整的製造與檢測儀器與技術，因此為提升本中心光學檢測與製作技術，並掌握國際精密光學儀器發展趨勢，以做為未來我國光學儀器產業技術發展之依據，派員赴德、法等國相關產業機構考察光學製造檢測技術發展現況，並赴法參加在巴黎舉行的光

電展與會議，以蒐集相關光電產品與技術的發展訊息。

為求光電遙測酬載長期目標之順利達成，除已參與中華衛星二號之遙測酬載研製計畫，以吸取國外公司經驗。同時為提昇本中心精密光學元件製造檢測技術，已陸續擴充並添購相關儀器設備，本年度並採購了「偏位分析與組裝系統」(Alignment & Assembly System)檢測設備，以做為光學鏡片或系統之檢測及組裝，本設備將於年底前運抵國內，乃指派同仁赴德國原廠受訓並做先前的驗收工作，並就相關技術問題做研討。

## 貳、目的

### (一)考察精密光學元件檢測技術現況與發展

德國為現代光學工業的發源地，從玻璃材料、光學製造加工機至光學檢測儀器有一完整的工業體系，歷史悠久且不斷創新改良。Trioptics GmbH 與 Moeller-Wedel Optical GmbH 均為德國以製造光學量測儀具起家的公司，其產品幾乎涵括所有光學元件量測、光機組裝檢測與分析設備，諸如有效焦距、曲率半徑、偏心量、稜鏡角度、折射率、光學調變函數 (Modulation Transfer Function, MTF) 及組裝偏位分析等的量測儀器產品齊全，藉由本次的參訪可以獲得相關儀器產品與技術的資料，除可就量測技術交換經驗心得外，並可與該公司工程師就精密光機量測儀器的設計與組裝等相關問題做討論。

### (二)驗收遙測計畫與光機實驗室所需組裝分析儀器

為提昇本中心精密光學元件製造檢測技術，自 89 年度起陸續擴充並添購相關製作與檢測儀器，包括非球面成型機、雷射定心機、非球面拋光機、輪廓儀與大口徑干涉儀等，建立起中心在精密光學元件製造上的優勢地位。

但目前本中心在光機組裝上，尚缺乏一套具精準組裝控制平台與軟體分析的設備，故本年度向德國 Trioptics 公司採購了「偏位分析與組裝系統」檢測設備，以做為光機組件或

系統之檢測及組裝，採用非接觸方式對光學鏡片或鏡組之定心測量與對準作業，亦可應用於檢測完成組裝之鏡頭整體定心誤差、機械誤差、焦長、曲率等。本設備將於年底前送交中心使用，故派員赴德國原廠受使用訓練與事前的驗收工作(詳細規格如附件一)，並就相關技術問題做研討。

### (三)考察光學製造檢測用定位平台之設計與技術

精密定位平台(linear or rotation stages)為製造檢測不可或缺的设备，而法國 Micro-Control 為 Newport 集團下專精定位平台之設計製造的公司，其產品在全球各地享有盛譽。藉本次的參訪可蒐集最新定位平台的資料與技術，並藉由與原廠工程師的討論，對於未來中心設計開發加工機台有直接的助益。

### (四)考察光學量測儀器申請 ISO 7025 認證評估方式

為提昇中心光學/光機檢測實驗室服務品質與運作效率，並建立產業對中心出具測試報告之公正性與專業性的信心，目前規劃申請中華民國實驗室認證體系(Chinese National Laboratory Accreditation; CNLA)認可符合國際標準 ISO/IEC 17025 的光學測試實驗室，未來所簽發之測試報告，將可具國際認可標準與共通接受性，達到「tested once, accepted everywhere」之目標。

依規定，申請認證之測試項目所使用的儀器與方法都必須做量測不確定度(Uncertainty)的評估，惟國內目前對光學測試領域方面的量測不確定度評估相當缺乏，因此藉由本次參



訪這些知名光學量測儀器廠商，了解其是否有相關評估經驗或方法，這對未來申請認證工作有很直接的幫助。

#### **(五)考察光電產品市場現況與技術發展**

巴黎光電展(OPTO 2003)為歐洲光電產業重要的展覽會之一，預計今年 10 月 21 日開始一連三天的會期，除了各大光電廠商的參加產品外，另有舉辦一連串研討會(conference programme)，本次舉辦單位以“The exhibition of all optical solutions for industry, networks and telecommunications.”為訴求，除了一般光電產品外，今年另專注於三個具高度發展潛力的領域，分別為 Biophotonics, Nanotechnologies and Opto City(heart of a metropolitan network)。

因此藉由本次參觀機會，一則蒐集資料，一則有助於了解光電產業與技術發展的趨勢，擴展本身視野，期能對未來前瞻計畫的研究上有更大的幫助。

#### **(六)建立光機技術交流合作管道**

光電產業為國內熱門產業，但目前光學設計、測試及光學機構人材較為缺乏，仍待培養，人材與經驗的缺乏將使得光電產業的發展受限，並使得關鍵技術或組件無法突破。而不管是 Trioptics GmbH 或是 Moeller-Wedel Optical GmbH 均在精密光學量測儀器的製造上有相當的經驗與技術，若能與該公司建立起技術討論或交流管道，甚至利用互訪機會或是派遣專家來台研討，將對於本中心光機實驗室技術能力的提昇與未來發展將有正面積極的幫助。

## 參、過程

行程表：九十二年十月十三日至十月二十四日，計十二天

日期	起	至	工作內容	天次
10/13(一)	台北	漢堡	Taipei(23:00)→Amsterdam(9:55)	1
10/14(二)			Amsterdam(12:30)→Hamburg(13:35)	2
10/15(三)		漢堡	參訪 Trioptics，考察光學製造檢測儀器與技術及儀器使用訓練	3
10/16(四)		漢堡	參訪 Trioptics，偏位分析儀使用訓練與儀器功能驗收	4
10/17(五)	漢堡	巴黎	參訪 Moeller-Wedel Optical 考察光學檢測儀器與技術 Hamburg(16:15)→Paris(17:50)	5
10/18(六)		巴黎	資料整理與撰寫	6
10/19(日)		巴黎	資料準備，聯絡參訪對象	7
10/20(一)		巴黎	參訪 Micro-Control	8
10/21(二)		巴黎	參加法國光電展與會議 (OPTO 2003& Conference)	9
10/22(三)		巴黎	參加法國光電展與會議 (OPTO 2003& Conference)	10
10/23(四)	巴黎	台北	搭機返國	11
10/24(五)			Paris(11:20)→Taipei(07:00)	12

(一). 參訪 Trioptics GmbH, 考察光學製造檢測儀器與技術及儀器使用訓練

十月十五日早上九時該公司派員到旅館接送前往該公司，經過簡短的介紹與認識後，與該公司老闆 Eugen Dumitrescu 討論接下來兩天的行程安排，第一天直接進行儀器的功能介紹與使用訓練，第二天則是因為本中心陳主任與黃鼎名博士也將一同到訪，屆時再參觀該公司各實驗室、了解該公司最新研發設備並進行問題的討論與交流。

隨後在該公司研發經理 Josef Heinisch 的帶領下，先參觀了實驗室中由本中心所採購的偏位分析儀設備，正由該公司工程人員進行整體的調整與校正工作，且預計在十月十七日裝箱空運到台灣來。因此本次的使用訓練以該公司實驗室內相同功能的其他機型來進行。由於 Josef 本身對產品軟硬體相當熟稔，且採一對一的教學方式，使得在軟硬體的操作使用外，也針對其量測原理多有說明，對於筆者的問題也都能有討論並得到說明，真可謂是受益良多。茲就該儀器使用訓練流程與其功能簡述如下：

1. 鏡片或系統組裝對心調校與檢測

對心誤差檢測依其工作原理大致可分成穿透(Transmission)與反射(Reflection)兩種方式，可由下圖示來說明，由準直儀(Transmission mode)或是自準直儀本身(Reflection mode)發出的十字標靶經由鏡片透射或反射進入自準直儀內的 CCD 或目鏡，當鏡片或鏡組本身有偏心誤差存在時，隨著旋轉平台的轉動，由 CCD 所觀察到的十字標也會繞出圓形的軌跡，此圓形軌跡的半徑其代

表偏心量的大小，半徑愈大，偏心誤差就愈大。

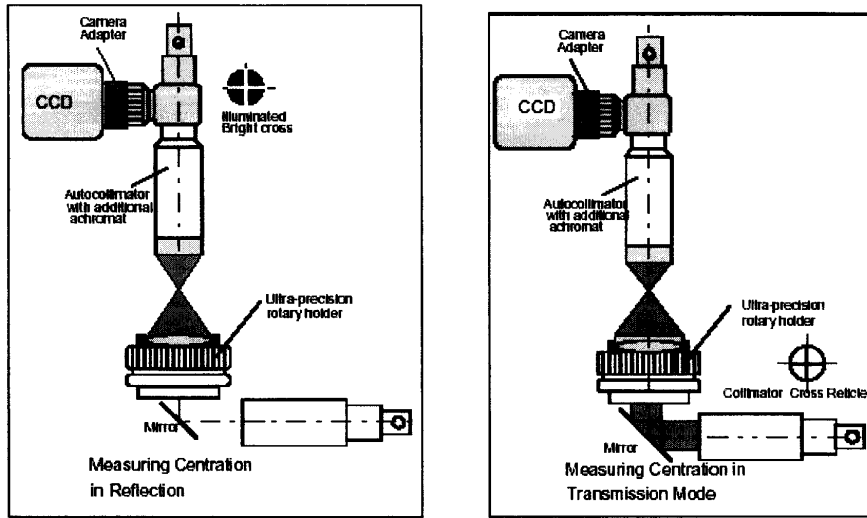

## 2. 曲率半徑量測

曲率半徑的量測除了自準直儀外，還需要一光學尺做位置的紀錄。其原理是由自準直儀發出的十字標靶可由鏡片頂點表面(cat's eye position)以及鏡片曲率中心處(center of curvature)反射回到自準直儀並成像在 CCD 上，藉由光學尺紀錄兩個位置的差，可以求得鏡片的曲率半徑大小，如下圖所示。

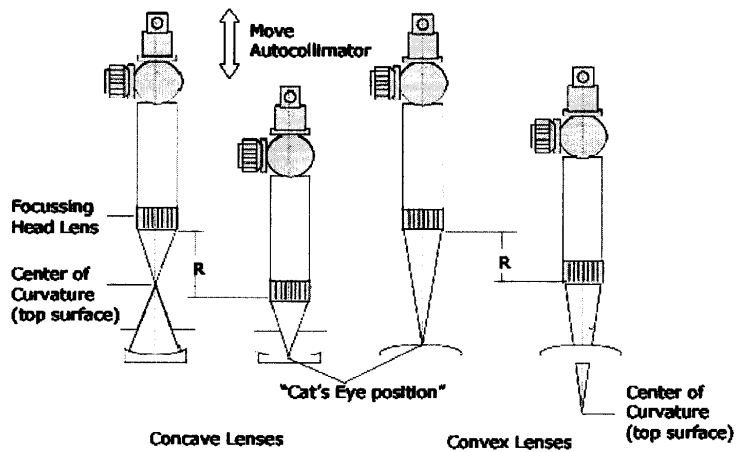

### 3. 有效焦長(Effective Focal Length)

有效焦長的量測需要一已知寬度的雙狹縫標靶，由準直儀發出的光經過雙狹縫後，打在待測的光學元件或組件上，經過一 Relay lens(或 headlens)後，進入自準直儀內成像在 CCD 上，其詳細光路可由左圖中得知。

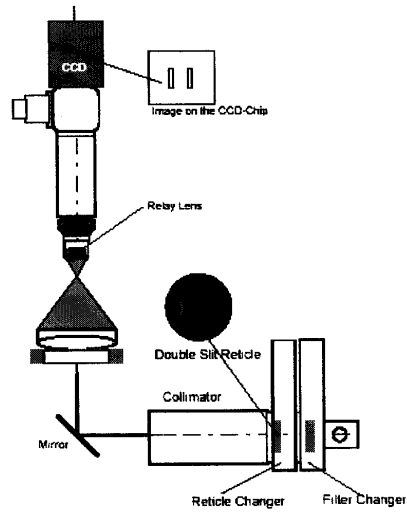

計算成像在 CCD 上的雙狹縫

寬度，與原雙狹縫寬度相比可得到其放大被率，進一步利用自準直儀與 relay lens 的焦距長求得待測件的有效焦長，其關係式如下，

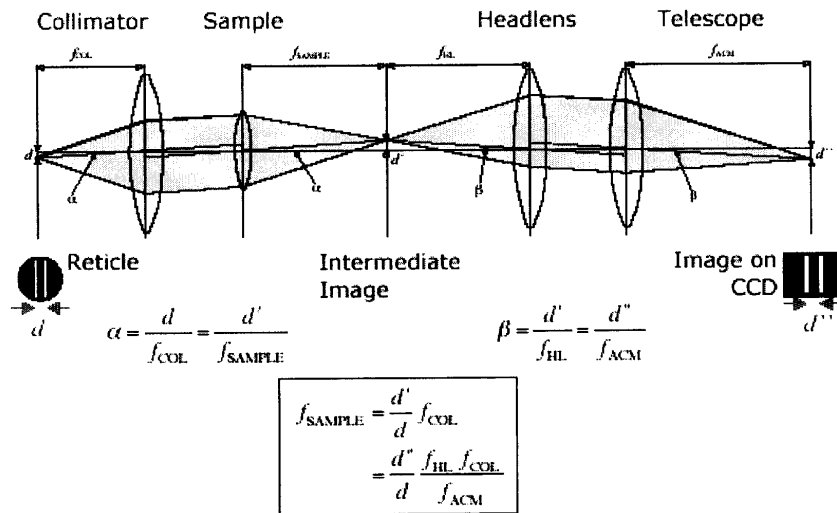

### 4. 背焦長(Back Focal Length)

紀錄上述有效焦長的位置，再利用自準直儀找到鏡片表

面頂點的位置(cat's eye position)，由上兩位置的差可以計算得鏡片的背焦長度。

### 5. 楔形角度量測(Wedge measurement)

楔形角度的量測乃利用上下兩表面分別反射由自準直儀來的十字絲光線，計算兩光點在 CCD 成像面的距離，可以求得此楔形角度的值，也常用來檢測光學平板的平行度。詳細光路安排與關係式可由下圖表示，

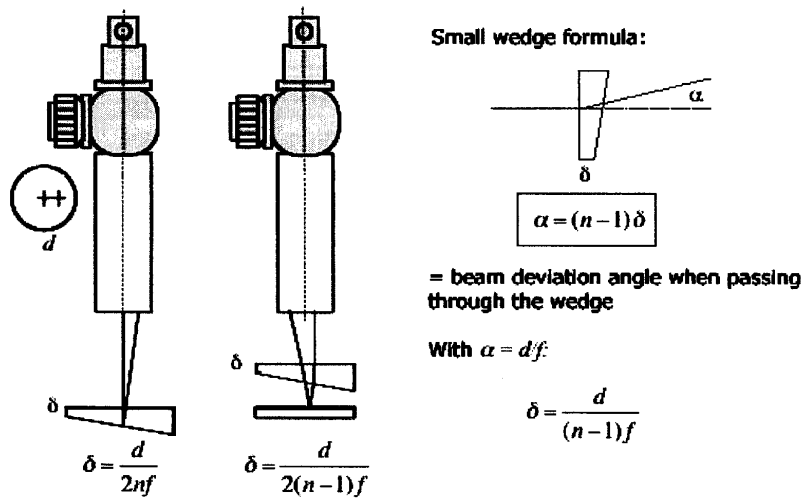

利用此楔形角度量測方式，也可用來驗證本套儀器的量測精度，本次所購買的附件中，有一已知角度的標準楔形平板，其角度是由德國 PTB (Physikalisch-Technische Bundesanstalt)所校正，可用來驗證自準直儀量測的準確度與解析度，並且具國際量測追溯性。

### 6. 擺動量測(Wobble Measurement)

由待測表面反射回自準直儀的光點或十字標靶，當待測件旋轉時，可觀察其在 CCD 上的軌跡，即是其擺動誤

差。旋轉平台的精度會嚴重影響待測結果，因此需特別考量，中心所採購的設備其旋轉平台是採 air bearing 的高精度旋轉平台。

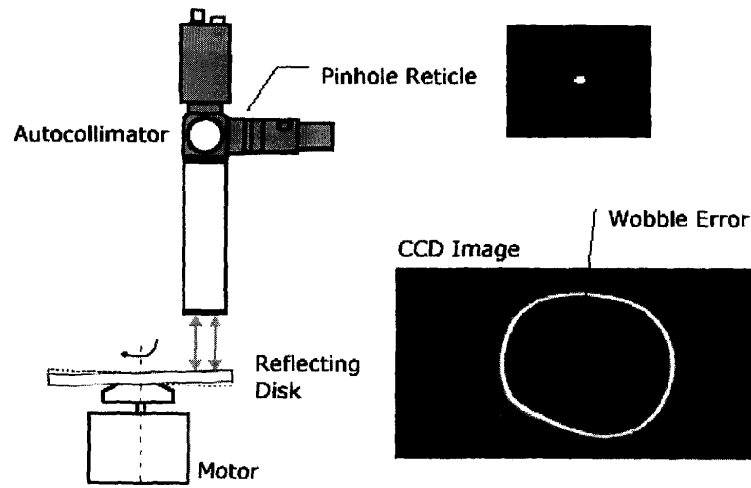

經過一整天訓練與討論後，筆者對這台儀器的功能與操作使用有了更清晰的了解，相信對往後工作的進行可以更便利。

第二天的行程則是由甫結束法蘭克福考察光學製造加工技術的陳主任與黃鼎名博士一同前往參訪，到達該公司後由老闆 Eugen Dumitrescu 親自接待並全程陪伴參與討論。首先由黃鼎名博士簡報中心遙測發展與光學製造技術現況，以及未來規畫方向，除讓對方更了解精儀中心外，更希望藉由這樣的簡報在未來研發過程中獲得更多的支援與協助，甚至建立起雙方技術交流合作的管道。

精儀中心的簡介後，由 Trioptics 老闆與 Josef 共同簡介該公司與各項生產的檢測儀器，該公司商品化產品主要分成

四大項，

- a. OptiTest：有 OptiSpheric、OptiCentric 與 OptiAngle 等量測儀器，涵蓋偏心誤差、有效焦長、曲率半徑、角度或平行度和 MTF 等等的量測，本中心所採購儀器即屬這項類。
- b. Prism Master：專門設計來量測稜鏡角度的儀器，依其量測方式可分為絕對(absolute )與比對(comparison line)量測兩種。
- c. Spherometer：即球徑計，為一種方便快捷量測曲率半徑的儀器，精度高且較不受操作者個別因素影響。本中心光學早已在數年前就使用該產品。
- d. Autocollimator：自準直儀，為其大部儀器的最基本配備，可分成目視與電子式兩大類，其用途非常廣泛，準直校正的各種檢測都可以運用的上，如組裝定位、平坦度或

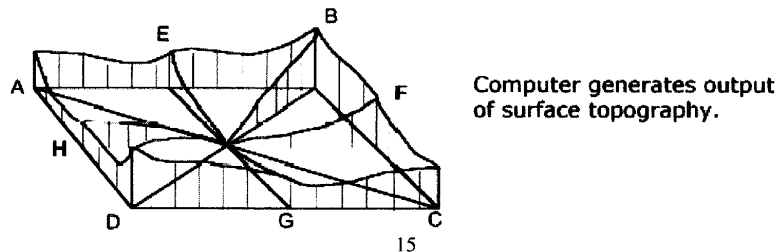
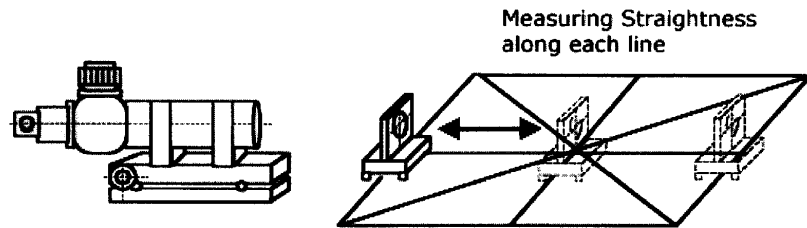



垂直度檢驗等等。

除此之外，近年來也針對客戶的個別需求開發新的檢測儀器，例如 MTF 檢測儀(如左圖)，與一般 MTF 量測儀器不同處是，這套儀器專為手機數位相機鏡頭檢測之用，有特別的鏡頭夾持載台，同時有五個 sensors 在不同角度(含軸上 On-axis)的 MTF 量測，因此可以迅速得到五個角度的 MTF 值量測結果，兼具線上大量檢測的優勢，下圖為其量測的結果畫面，

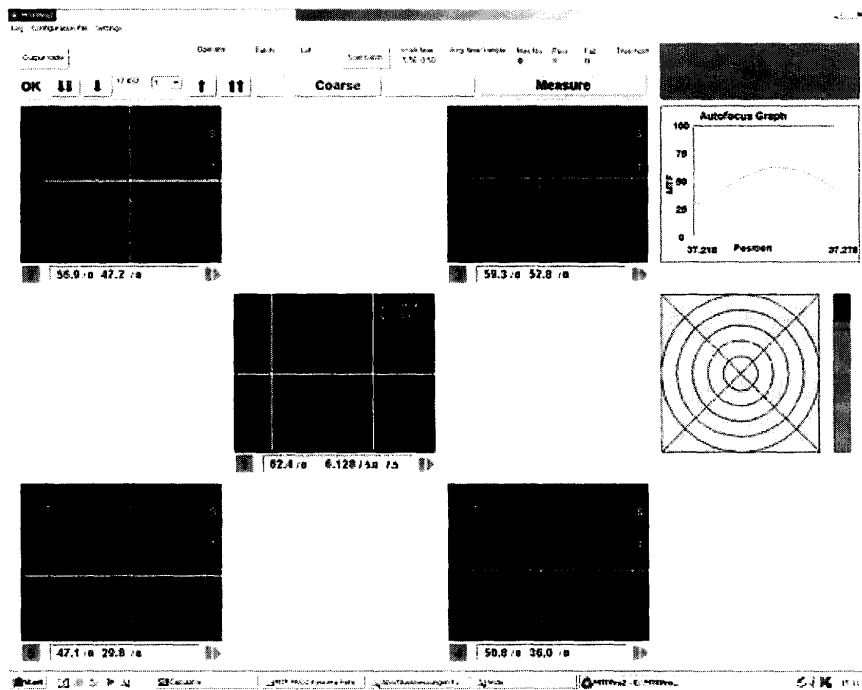

另一針對客戶需求所設計，在原有對心量測設備上搭配自動點膠機、壓電片制動調整裝置與 UV 燈所組成的自動對心點膠機台，為一自動化鏡片與鏡筒組裝灌膠的設備，非常

適合高精度且須大量生產的需求，值得我們學習並改進現有組裝調校程序。

膠水注射筒

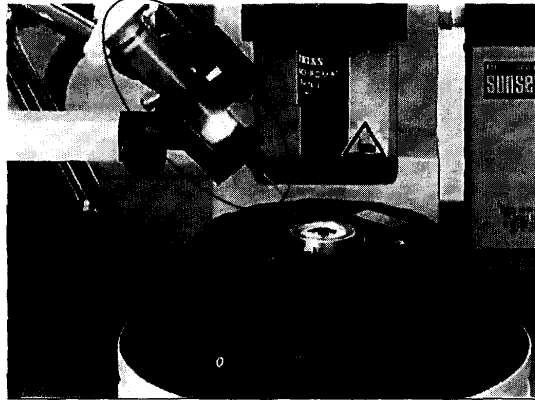

在隨後的實驗室參觀過程中，也特別介紹該公司兩部研發中的儀器，都是用來量測建構待測面表面特性，包含三維外形與表面粗糙度等，其量測原理(如下圖)是利用待測面表面對入射光反射後波前形狀誤差的改變來獲得待測面表面傾斜度(斜率)，經由積分運算得到表面的形狀，

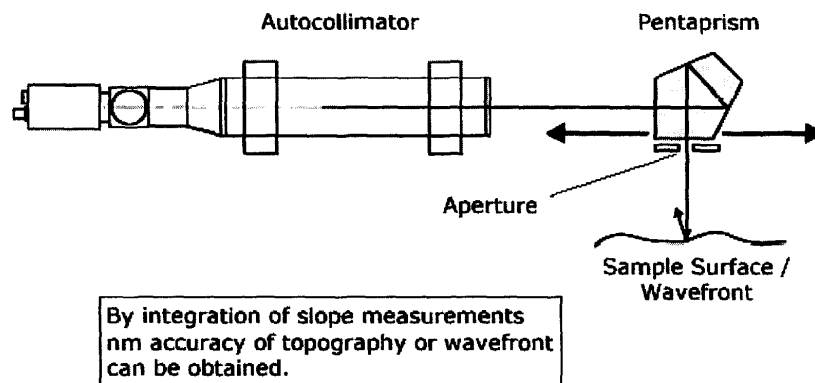

另一項研發的儀器(Deflectometry)則是一項合作的研發案，主要用來量測矽晶片的表面平坦度，目前是以 12 吋為

目標，與一般 3-D profiler 最大的不同是，它的量測時間相對短很多，只需將矽晶片旋轉一圈就可完成掃描，其原型機內部構造如下圖示，

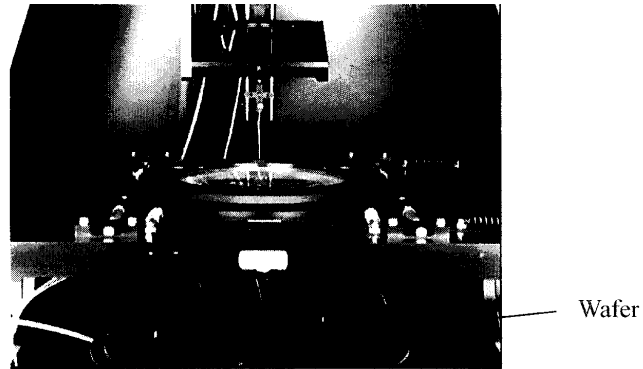

Trioptics 目前員工約只有二十多位，負責產品前段的研發設計與後段的組裝與調校，至於光機元件的製造生產則完全交由其協力廠商，因此其工作環境顯得簡單而整齊，人員少卻能發揮最高經濟效益，從簡單的原理充分運用發展出多樣的檢測儀器，值得我們深思與學習。

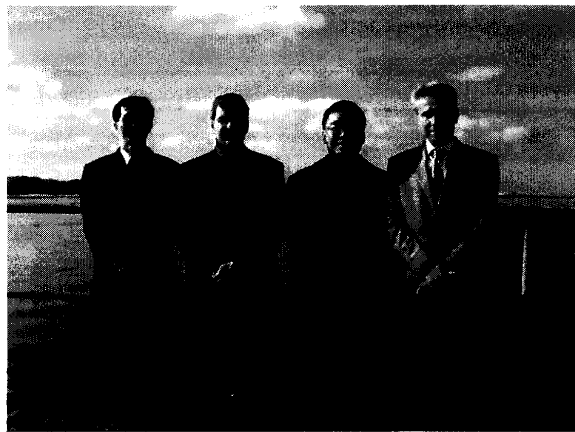

(二). 參訪 Moeller-Wedel Optical，考察光學檢測儀器與技術

參訪當天的行程由該公司負責人 Carsten Schlewitt 全程介紹並參與討論，在由黃博士簡介中心目前計畫與未來規劃方向後，Carten Schlewitt 也為我們介紹該公司的背景與所生產的高精度檢測儀器。

Moeller-Wedel Optical 創立約一百五十年，主要製作光學檢測所需之高精度準直儀、自準直儀、角度儀、干涉儀等，目前屬於 HS 集團下之一支。Trioptics 公司也是一些該公司離職人員所創立，也因此兩家公司所生產的光學檢測儀器同質性也相當高，都是利用準直儀及自準直儀的搭配來量測光學性質或進行光學調校，如系統焦長、稜鏡角度、光軸對準等等，而角度儀基本上就是搭配角度量取設備(angular encoder)所做成。

準直儀及自準直儀標準產品焦長由 90 mm ~ 1100 mm，也有焦長 2000 mm 口徑 250 mm 之準直儀。與 Trioptics 類似，該公司只負責前段研發設計與後段的組裝調校，而大部分的光學與機構零組件都由其協力廠商製造提供，準直儀及自準直儀內中所放置之 reticle 玻璃由協力廠商完成，協力廠商資料如下：

POG Präzisionsoptik Gera GmbH  
Gewerbepark Keplerstr. 35  
D – 64734 Gera  
TEL: +49 6163 912130  
FAX: +49 6163 912132

[www.precisionsoptic.com](http://www.precisionsoptic.com)

[praezisionsoptik@t-online.de](mailto:praezisionsoptik@t-online.de)

儀器使用介面方面該公司與 Trioptics 使用 PC 及影像擷取卡概念不同，走的是專用控制器的路，主要考量在於輕量、可移動、現場操作，此外若影像擷取卡或 PC 做業系統更換，無需擔心維護問題。此專用控制器由合作廠商 Schnabel 負責開發，軟體也由此公司負責，控制器可與 PC 接線，下圖為該公司 ELCOMAT 電子式自準直儀使用情形，圖中右方即專用控制顯示器。

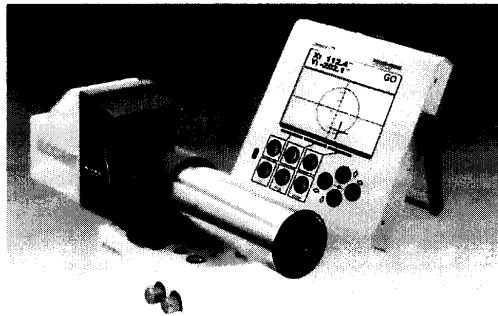

有關變焦鏡頭之測試，該公司也研發了一套專用量測設備(右圖)，當鏡頭變焦後，可以上述量測有效焦長(EFL)方式測得焦平面變化量，此變化量即為一般相機生產廠商所在意之品管參數。

該公司同時也生產干涉儀，有 4" 及 6" 干涉

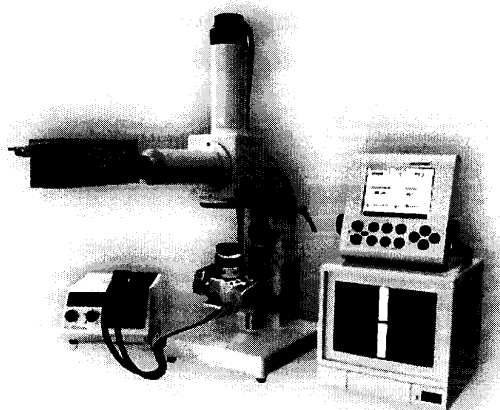

儀及小型干涉儀，如下圖所示。4”及 6”干涉儀標準平面精度為  $\lambda/20$  甚至達到  $\lambda/50$ (定製品) p-v 這樣的精度，標準球面則為  $\lambda/10$ 。

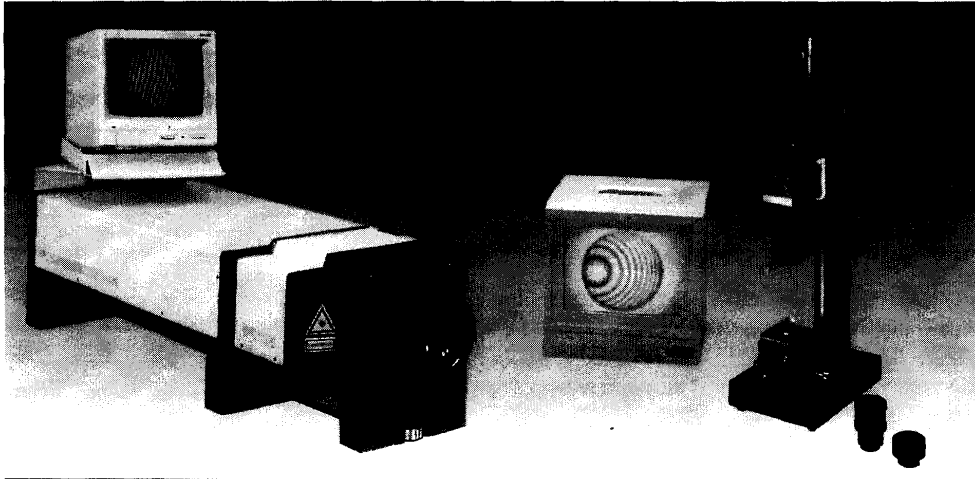

該公司地下室內另有一溫度控制之實驗室可做為角度校對標準用，該標準回溯至德國 PTB，系統焦長部份則回溯至英國 NPL，可稱為二級標準，有關於不確定度的計算，該公司也不甚清楚。

參觀該公司時發現其物料管理也相當完善整齊，元件均有個別的抽屜儲放，需要時再取出；且因為機械及光學元件並不在組裝地點製造，委由集團分公司及協力廠商完成，因此工作環境維持相當好。

### (三). 參訪 Micro-Control

Micro-Control 公司位於巴黎市郊的 Evry，1991 年加入美國的 Newport 集團，主要負責定位平台的設計製造，為 Newport 集團在歐洲市場銷售與技術服務據點，本中心遙測技術研究室先前所購買之六軸定位平台，即為該公司所設計製造，本次參訪目的除了收集最新資訊，以供光機實驗室各項整測所需外，也觀摩該公司各檢測與組裝實驗室的建置與管理。



Micro-Control 公司創立於 1962 年，為了要研發出各式各樣的定位平台，該公司陸續成立各研發實驗室，經過近 40 年的發展與轉型，其產品、系統與零組件在世界各地以享有盛譽。該公司產品主要往模組化發展，Micro-Control 強調大部分的定位系統都可以經由一些基本的平台組構而成，同時考量組裝時之系統精度與穩定性的保持，該公司非常注重單件的互換性，此可由各個產品使用書上的組裝說明得知。不過，該公司的電機模組化設計卻使得機械的相容性受限，也

因此致使該公司在超精密定位系統相容性的研發上投入相當多的經費與人力，為求擴展市場的佔有率與提高顧客滿意度，加入了 Newport 集團的研發行銷團隊。

目前 Newport 公司的產品主要可分為五大類：定位移動平台 (Motion Control)、光學元件 (Optics)、光機零組件 (Opto-Mechanics)、光電量測儀器 (Photonics) 與振動控制儀器 (Vibration Control) 等，而 Micro-Control 廠主要提供 Newport 集團所有定位系統，包含線性與旋轉驅動平台、控制器及相關操作軟體。

近年來由於加工機或是檢測儀器的精度要求愈來愈高，相對的對於定位控制平台的要求也愈趨精準，因此 Micro-Control 以其過去良好的基礎，這兩年來更專注於提升精密定位平台的解析度與控制，右圖所示為今年新產品，其中旋轉平台已達  $0.0001^\circ$  的角度解析度，定位平台的解析



度目前也已經做到  $0.02\mu\text{m}$  的等級，圖中左方則為其商品化的微動平台，最大行程為 5mm，解析度  $0.02\mu\text{m}$ ，可承載重量為 50 牛頓。而針對過去使用螺桿或是螺旋測微頭等手動方式的移動平台，Micro-Control 發展了一種高精度的制動器 (Actuator)，具有大行程且高載重特性，可用來驅動平台的移動，這對於整個控制自動化的實現有很大的實質幫助，詳



細規格資料可參閱附錄頁。

另外，Micro-Control 也積極發展新的控制系統，今年最新的 XPS (Integrated Motion Controller/Driver System)除可以同時控制 1-8 軸的運動外，可用來驅動大部分的定位平台，其同時具網路通訊能力，允許多個使用者由遠端控制的功能，這意味著以後的實驗或量測，可能不需要隨時在側，由遠端的電腦控制就可以了，大大提昇了網路帶給的便利性。

#### (四). 參加 2003 法國光電展

巴黎光電展(OPTO 2003)為歐洲光電產業重要的展覽會之一，從 10 月 21 日開始一連三天的會期，在巴黎展覽會場(Parc des Expositions de la Porte de Versailles--Hall 7.1)舉行，同時舉行的還有一個量測儀器的展覽會，規模上大約跟台北世貿中心的展覽一般大小，並不是特別大，但是整個展覽會場(Parc des Expositions de la Porte de Versailles)則相當地大，包含了好幾個場地，光電展所在的 Hall 7.1 只是其中的一個而已。

整體而言，此次光電展展出的內容與國內今年光電展所見有很大的不同，國內有很大的比重在平面電視方面(如 TFT-LCD、電漿電視、背投電視)及其相關產業的展出內容，而巴黎光電展所見的產出內容顯然有很大的不同，其多樣性是國內光電展所不及的，因此對於一個光電方面的研究人員或是產業而言，參加這樣的一個展覽確能收到增廣見聞與了解目前國外光電產業發展的趨勢與技術。本文將針對與中心相關研究或光學技術有關聯的一些展出項目做探討說明。

#### 微致動器

因應未來奈米產業的發展，已有很多家公司發展出以壓電材料驅動的微致動器 (Piezo Actuator) 或平台 (Piezo Positioning System) 等商品化產品，其精度均可達到奈米等級，右圖即為德國 piezosystem jena 公司的一系列微致動平

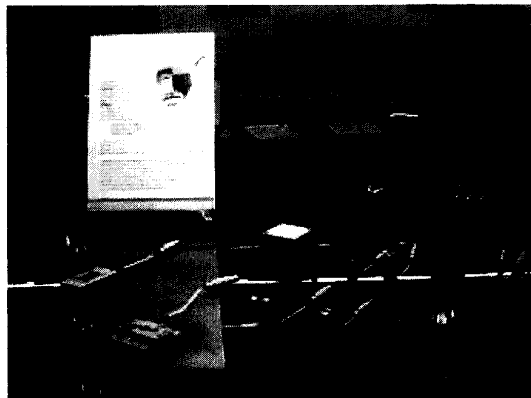

台，其喊出的口號即為「NanoStep will be the future.」；另上文介紹過的 Newport 與法國的一家名為 TSA 的廠商 (<http://www.tsa.fr>)也有相關的產品產出，其產品詳細規格詳見附錄。

### 影像辨識系統(Imagechecker)

數家業者展示了影像辨識系統專供製造線上品質的監控，包含標籤或其成品的篩檢等；其系統架構主要包含一配備鏡頭的 CCD 感測器與光源，加上電腦影像軟體的分析判別，可以很快速的取像並做出便別。



右圖為 NAIS 展示的影像辨識系統，可以根據所設定產品的形狀、大小、顏色或尺寸等做出判別，乃至於標籤的印刷或包裝等等做品質管控。

另有一家業者(Matrox imaging)展示在一旋轉平台上的眾多樂高積木中，挑選所設定外形的積木；或是辨別隨旋轉平台轉動中的汽車 (Cognex, vision for industry)。右下兩圖分別為這兩家公司的展示品。



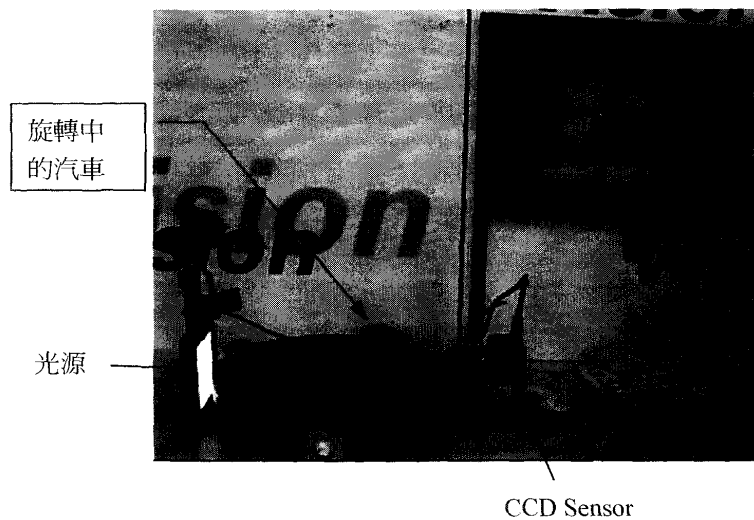

### CCD Sensor

由於國內並沒有製造 CCD 感測器的廠商，因此對於高品質 CCD 或是特殊用途 CCD (如紅外波段、太空規格) 的取得往往受到很多限制。本次巴黎光電展覽會場就有幾家專門製造 CCD 的廠商展示其商品，其中不乏屬太空規格以及紅外波段用的 CCD。較熟悉的有 BASLER 公司(本中心 89 年度的八米遙測鏡頭所使用的 CCD 即是 BASLER 公司產品)，該公司除原有 CCD sensors 外，今年主打其一系列的 CMOS 感測器，右圖為會場所展示 1280x1024 pixels，500 images/s 的 CMOS sensor。

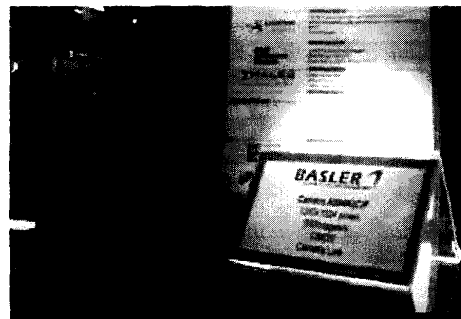

另外有加拿大的 BALSAL 與英國的 e2v 公司，都有一系列的 CCD 產品展示，日本 Hamamatsu 也有一系列包含 CCD 的光感應器，相關選購資料詳見附錄。英國 e2v 會場並有特

殊用途的 CCD sensor 產品，如 UV、IR 波段以及太空規格等級的產品，筆者詢問會場人員其產品是否有輸出許可限制的問題，該展售人員認為應該沒有，但也無法十分確定。

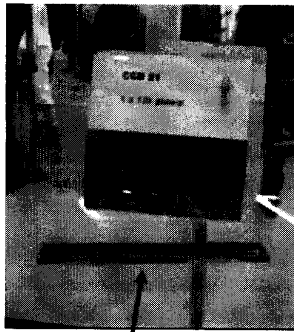

12,000 pixels  
linear CCD



### Wavefront Sensor

展示光學檢測儀器的廠商中，以法國 Image Optic 所展示的波前量測儀(wavefront sensor)特別引人注意，其所研發的 HASO 系列波前量測儀是利用 Hartmann-Shack 原理，主要硬體架構包含有雷射光源、CCD 以及電腦分析軟硬體外，關鍵元件就屬一片的 microlenses array，主要作用是將入射的波前切分成一段一段的入射波，每一小段的入射波可以看成

有傾斜角度的平面波，經聚焦後成像在 CCD 上，根據聚焦位置的偏移計算出此小段平面波的傾斜角度(local slope of the wavefront)，從而建構出整個入射的波前。

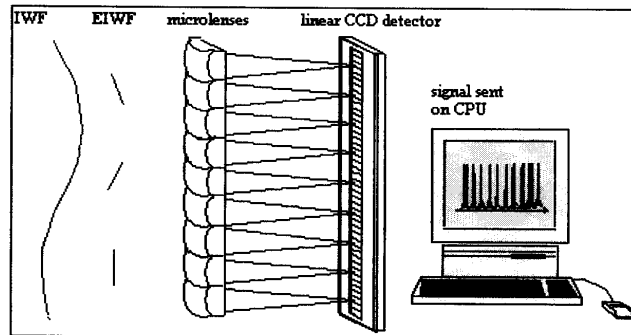

此種儀器的優點是架構簡單輕便，也不需要使用任何的參考平面，屬於波前的絕對量測，不管是用來光學系統的組裝調校、焦平面調整甚至是光學元件製造檢測都非常適用，而且可以即時(real-time)見到調校檢測過程，與干涉儀相比，這樣的儀器更適合用來做組裝調校之用。

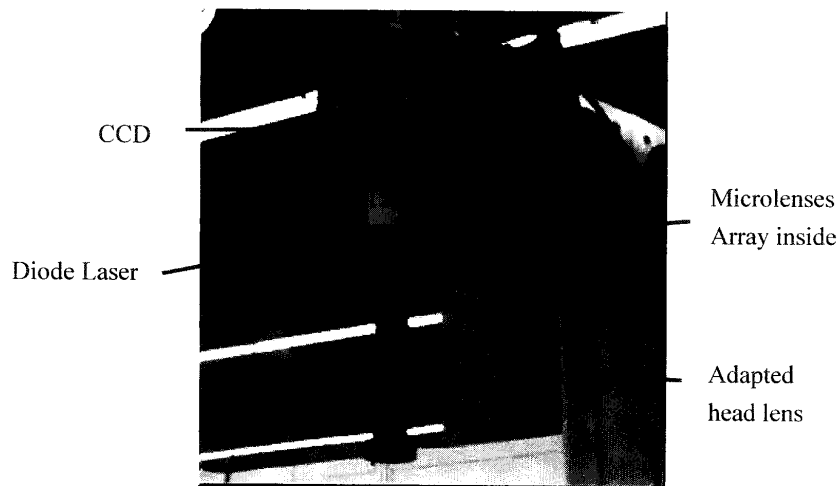

當天會場上，該公司特別展示利用該儀器檢測並調整一

具 10 英吋口徑的 Schmidt-Cassegrain 天文望遠鏡，其光機設計均與中心先前計畫執行的 8m-GSD 或 16m-GSD 遙測影像模組類似，因此其應用與量測技術可以做為未來研發大口徑遙測影像模組組裝整測的參考。其量測架構與輸入結果畫面，如下圖示說明，詳細資料參考附錄頁。

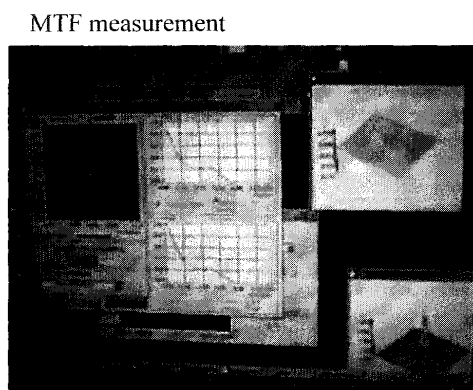
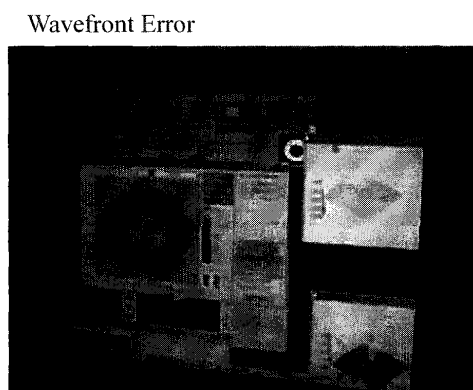
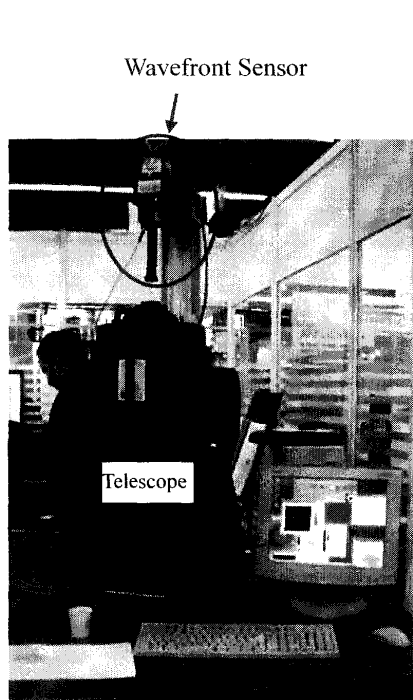

### 光學元件

除了像 Newport 以及 Melles Griot 等較熟悉的光機零組件廠商展示一般光學元件成品外，就屬德國 Berliner Glas 這家公司的展示的光學元件最引人注意，各種奇形怪狀的鏡片、輕量化減重鏡片等等成品展示充分顯示該公司精密的光

學製造技術，就技術與發展方向言，都相當值得中心光學廠

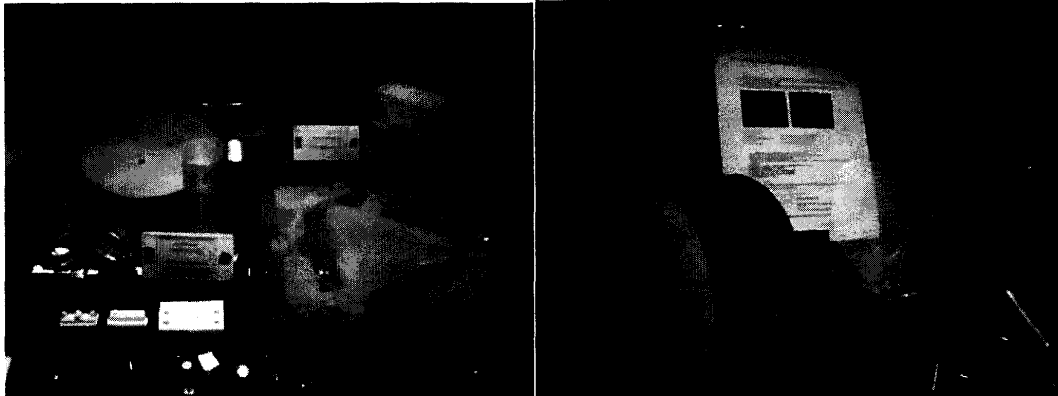

學習；該公司並在 2001 年取得瑞士一家精密光學製造公司 SwissOptic 大部分股權，一樣具備特殊光學鏡片製造與光機設計能力，比較值得一提的是，在光學元件上製作一微結構圖樣與鍍製的能力，如右圖示。

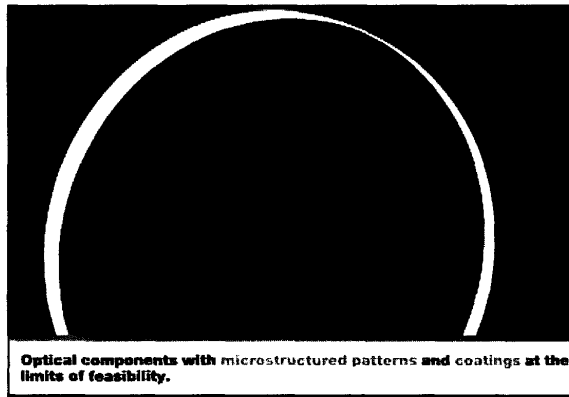

蘇格蘭的 SPANOPTIC 與法國的 SOREM 也都有各式的精密光學元件的展出，相關資料起參閱附錄。另一家較具特色的是總部位於瑞士的 LEISTER Microsystems，其所展示的 Microlens Arrays 與光纖通訊用的 Fiber Collimating/Coupling Lens Arrays 都已經是商品化的成品，未來應用層面將相當廣泛，詳細資料請參閱附錄頁。



## 肆、 達成任務

本次出國目的之一為赴德國原廠就中心本年度採購「偏位分析與組裝系統」(Alignment & Assembly System)檢測設備做先前驗收工作與使用訓練，以擴充本中心在光機系統組裝檢測之技術；另一目標為考察德、法相關產業機構光學製造檢測技術發展現況，並蒐集相關光電產品與技術的發展訊息，以利未來研究發展之依據。茲將此次考察所達成任務，概述如下：

- (一) 「偏位分析與組裝系統」檢測設備，由於先前的準備與溝通，目前已經順利完成在本中心的安裝與驗收工作，相關設備與夾治具也全部移交給中心同仁使用。由於在Trioptics 原廠除了系統軟硬體的操作使用訓練外，也針對其量測原理多有說明（參考上章節過程內容），使筆者對自準直儀量測技術有更深層的認識，相信對未來研發工作有一定的助益；而原廠工程師 Dr. Stefan Krey 於本中心光機實驗室對同仁的使用訓練課程上，也因為事先資料的研讀，充分達到協助與解釋溝通的角色。
- (二) 為建立本中心出具測試報告之公正性與專業性的信心，申請認可符合國際標準的測試實驗室，已是未來趨勢，使得未來簽發的測試報告具國際認可標準與共通接受性。目前中心規劃申請的光學測試實驗室，由於國內並無類似的申請案例，因此藉由本次的考察行程，了解國外的做法，目前已經知道其量測儀器的驗證如何做標

準的追溯，其追溯的單位為主要為德國 PTB(自準直儀角度)與英國 NPL(有效焦長)，因此將來申請相同量測項目的認證時，可以直接購買經該機構認證並出具報告的標準件(master piece)做量測的追溯。

(三) 巴黎光電展(OPTO 2003)為歐洲光電產業重要的展覽會之一，本次參觀所蒐集資料如微致動器、影像判別、CCD等，都與中心目前研究計畫有直接的關聯性，甚至是可以協助解決目前研發上的問題(如 wavefront sensor)，因此可謂獲益良多；除此之外，參加這樣的一個展覽會確能收到增廣見聞及有助於了解光電產業與技術發展的趨勢，對一個光電方面的研發人員言，將有助於未來前瞻計畫的研究。

(四) 光電產業為國內熱門產業，但目前光學設計、測試及光學機構人材較為缺乏，仍待培養，人材與經驗的缺乏將使得光電產業的發展受限，並使得關鍵技術或組件無法突破。本次參訪的單位，都是在精密光學量測儀器或是光機零組件製造上有相當經驗與技術且具國際知名度的公司，經由本次行程除獲取相關儀器產品與技術的資料外，並有機會就精密光機系統的設計與組裝等相關問題做討論。目前與原廠工程師仍有電子郵件往返，若能建立技術討論或交流管道，甚至利用互訪機會或是派遣專家來台研討，將對於本中心光機實驗室技術能力的提昇與未來發展將有正面積極的助益。

## 伍、心得與建議

- (一) 實驗室品質管理要求：參訪德國的 Trioptics 和 Moeller-Wedel Optical 兩家公司，均將光機元件的製造生產交由其協力廠商，本身只負責產品的設計研發以及最後的組裝調校工作，因此其工作環境顯得簡單整齊，物料的管理也是井然有序，這種環境與秩序實在有賴實驗室每個人的共識與努力。而 CNLA 實驗室認證的兩大要求之一就是品質管理，這可能是我們要在加強要求的。
- (二) 簡而精的研發方向：論這兩家公司的規模都不大，其製造的光學檢測儀器卻可以行銷全球，人員少卻能創造很高的經濟效益，這與台灣大部分產業以「量大」「廉價勞工」的取向有很大差別，或許這就是「知識經濟」的精神。其研發的產品雖然很多，但深究其原理，卻都是建立在相同的理論上，從簡單的原理充分運用而發展出多樣的檢測儀器，值得我們深思與學習。
- (三) 國際觀的視野：這次巴黎光電展整體規模並不是特別的大，但展示內容相較於國內的展覽則顯得多樣且新奇，其衝擊遠比參觀國內光電展來的大許多，對一位研發人員而言，的確收到了擴展視野的效果，也有助於國際光電技術趨勢的了解，特別是現階段出國考察經費很有限的情況下，應多利用藉參加國際性的展覽會，以最短時間與最少經費拜訪廠商與蒐集相關資訊，以掌握產業脈

動與技術的發展。

- (四) **建立符合國際標準認證的光學檢測實驗室**：即使是有優良傳統歷史的光學儀器製造商，面對客戶質疑其儀器的檢測能力與精度時，仍須一符合國際標準認證的量測實驗室出具檢測報告為其背書，並使得其量測具追溯性原則。而國內目前並不具有這樣的光學檢測實驗室，精儀中心累積多年之光、機、電及儀器整合技術，近年來又大舉擴充在光機製造、檢測之能力技術，應是國內最具有申請光學量測認證實驗室能力的單位，為這方面量測不確定評估較缺乏，應多參考國外相關機構經驗，加強建立交流管道，以建立國內第一間符合國際標準的光學檢測實驗室。
- (五) **團隊研發精神，內外交流管道的建立**：在強調與國外技術專家建立合作互訪或是交流管道的同時，研發人員也應建立「teamwork」的精神，以技術研討或是解決工程問題的會議似乎偏少，以致流於單打獨鬥，各練獨門功夫，且無法達到提攜新進人員、技術傳承的目的，這方面有待大家的共同努力。

## 陸、 附錄資料

**piezosystem jena**



**product  
news**

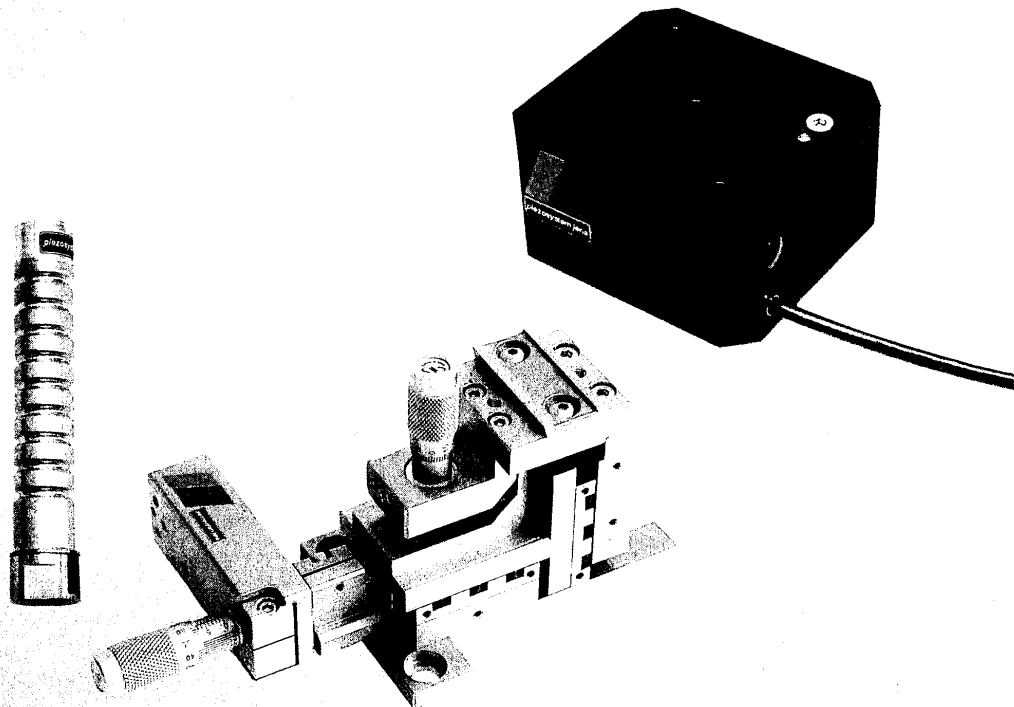

**NANOSTEP WILL BE THE FUTURE - WALK WITH US**

## Piezoelectric Micro Objective Positioning System **MIPOS 5**

- piezo focus adjustment
- very compact design
- 500  $\mu\text{m}$  adjustment range
- parallelogram construction
- high resonant frequency
- easy to mount on microscopes



The MIPOS 5 was developed for fine adjustment of micro objectives. The maximum motion is 500  $\mu\text{m}$ . The resolution of MIPOS 5 is very high and, in practice, only limited by the voltage noise of the power supply.

A special integrated pre-load design results in the following advantages:

- very small angular deviation
- highly parallel large range of motion
- high resonant frequency

On the top and bottom side of MIPOS 5 all standard threads are available from W 0.8 x 1/36" up to M27 x 0.75. Mounting this system on the microscope is very easy. You screw a thread-ring into the microscope and mount the MIPOS 5 on this ring with a clamping-screw.

recommended amplifier control system: NV 40 / 1 CL (see page 11)

### technical data

motion ( $\pm 10\%$ )	500 / 400 $\mu\text{m}$ (open / closed loop)
operating voltage	-10... +150 V
capacitance ( $\pm 20\%$ )	21 $\mu\text{F}$
resonant frequency ( $\pm 20\%$ )	200 Hz (with micro objective $m = 80 \text{ g}^*$ ) 180 Hz (with micro objective $m = 100 \text{ g}^*$ )
connector	LEMO
length of cable	1 m
option	strain gauge measurement system

\* small signal value

Please note: additional information for dynamical use after request

**Piezo Actuator series PA / T  
with M14 outside threading  
PA35/T14; PA50/T14; PA80/T14**

**Piezo Actuator series P / S  
hermetic insulated  
P 50/S13**

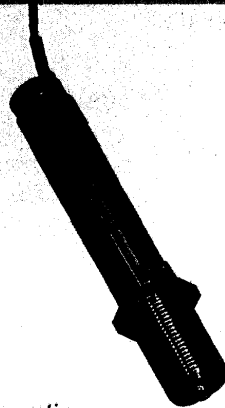

- outside thread for mounting
- versatile use
- excellent dynamical behavior by integrated pre-load
- very small and compact design
- high force generation
- high stiffness

These actuators are mechanically pre-loaded to make them ideal for dynamical applications. They can handle loads up to 1000 N. The housing of the actuator in combination with the springs allows a motion without mechanical play. The M14 outside threading is used to mount the actuator. It also helps to adjust the position precisely. Depending on the chosen model maximum motions from 35  $\mu\text{m}$  up to 80  $\mu\text{m}$  are available. The operating voltage is -10 V...+150 V.

- universal use
- independent from environmental conditions
- very small and compact design
- stable against high pressure forces



The piezo actuators of the series P /S13 have a hermetically sealed housing. The special housing allows its use in aggressive and humid environments. The actuators are not pre-loaded. The construction of the housing tightly encloses the stack, thereby avoiding mechanical play. They can handle a load up to 1000 N. The M3-thread in the bottom plate allows an easy adaptation in existing systems and guaranties an exact positioning. Depending on the type, actuators with a stroke of 8  $\mu\text{m}$  up to 50  $\mu\text{m}$  are available. The operating voltage is -10V...+150 V.

**technical data**

motion ( $\pm 10\%$ )	35 / 50 / 80 $\mu\text{m}$
voltage	-10...+150 V
max. force	1000 N
stiffness ( $\pm 20\%$ )	30 / 20 / 12.5 N/ $\mu\text{m}$
capacitance ( $\pm 20\%$ )	3.6 / 5.4 / 7.2 $\mu\text{F}$
length	53 / 71 / 89 mm
diameter	14 mm
thread	M 14
spanner flats	13 mm
pre-load ( $\pm 10\%$ )	300 N

motion ( $\pm 10\%$ )	50 $\mu\text{m}$
voltage	-10...+150 V
max. force	1000 N
stiffness ( $\pm 20\%$ )	20 N/ $\mu\text{m}$
capacitance ( $\pm 20\%$ )	4.5 $\mu\text{F}$
length	71 mm
diameter	max. 13.3 mm
thread (bottom plate)	M 3
spanner flats	12 mm



## Piezo-Positionierer PXZ 400

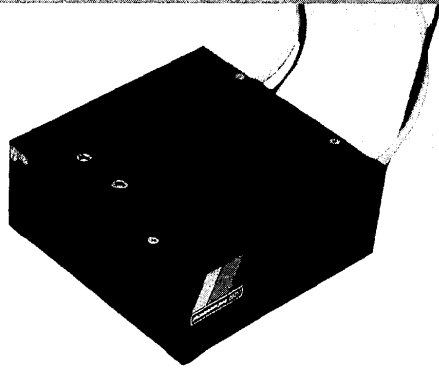

- motion 400  $\mu\text{m}$  in x-z axis
- compact and stiff design
- high resonant frequency

## Piezo-Positionierer PZ 400

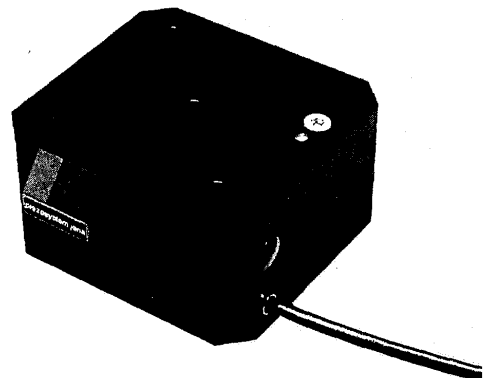

- motion: 400  $\mu\text{m}$  in z-axis
- compact design
- high resonant frequency

These new positioning systems allow a parallel motion of 400  $\mu\text{m}$  in the X- and Z- axes. With proper control electronics, a resolution in the nm range can be reached. An innovative new design combines a larger motion with a high resonant frequency. The compact size allows an easy installation in existing applications. When strain gauge (SG) position sensors are built in a drift- and hysteresis-free positioning is guaranteed. Vacuum and low temperature options are available.

recommended amplifier control system: NV 40 / 1 CL (see page 11); ENV 19" modular amplifier system

### technical data

part-no.	T-209-00 / T-209-01*	T-118-00 / T-118-01*
motion per axis ( $\pm 10\%$ )	400 / 320 $\mu\text{m}$	400 / 320 $\mu\text{m}$
capacitance per axis ( $\pm 20\%$ )	14 $\mu\text{F}$	4.6 $\mu\text{F}$
voltage	-10 V...+150 V	-10 V...+150 V
stiffness x/z axis ( $\pm 20\%$ )	0.35 / 0.3 N/ $\mu\text{m}$	0.25 N/ $\mu\text{m}$
resonant frequency x/z axis ( $\pm 20\%$ )**	300 / 180 Hz	280 Hz
connector	LEMO	LEMO
cable length	1 m	1m
size (l x w x h)	80 x 80 x 35,5 mm	48 x 52 x 28,5 mm
weight ( $\pm 10\%$ )	685 g	190 / 195 g

\* strain gauge version

\*\* small signal value

Please note: additional information for dynamical use after request.

## Nano Positioning System **PENTOR - 5 axis**

- combination of a three axes translation system and a two axis tilting system
- free center hole with 17 mm diameter
- integrated preload
- translation each axis: 100  $\mu\text{m}$
- tilt each direction: +/- 2.5 mrad
- solid state flexure hinges in parallelogram design without mechanical play
- integrated measurement system

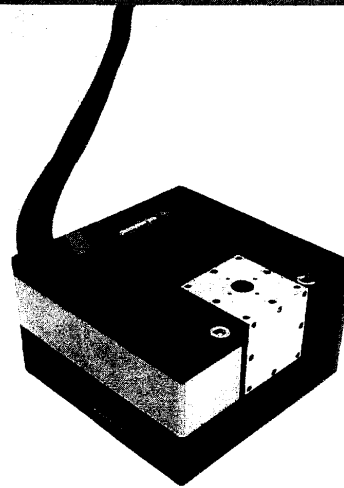

For fiber alignment optical stages often require an open central space (e.g. for passing light). For such applications, the new **PENTOR** (T-405-00) translation and tilting system was developed with a 17 mm free center hole. It offers a motion in XYZ of 100  $\mu\text{m}$  and a tilt of +/-2.5 mrad on two orthogonal axes.

Flexure hinges for the three translation axes guarantee the highest degree of parallelism over the travel range of the stage. Each axis has a built in integrated mechanical preload, making the new **PENTOR** very well suited for dynamic applications.

The tilting part is designed for "plus-minus tilting". The construction is temperature compensated: changes in the surrounding temperature do not affect the tilting angle. As an option, the **PENTOR** can be offered with an integrated strain gauge measurement system part.no. T-450-01.

### technical data

#### **PENTOR**

##### **Whole Actuator:**

operating voltage  
measurement system  
weight ( $\pm 15$  g)  
dimensions (length x width x height)  
free center space  
thread pattern  
cable length  
connector

##### **Translation:**

motion x,y,z ( $\pm 10\%$ )  
capacitance each axis ( $\pm 20\%$ )  
resonant frequency x/y/z-axis ( $\pm 20\%$ )\*\*  
max. load  
stiffness each axis ( $\pm 20\%$ )  
temperature range

##### **Tilt:**

number of axes  
tilt ( $\pm 10\%$ )  
pivot points  
capacitance each axis ( $\pm 20\%$ )

##### **Vibration options:**

#### **T-450-00**

-10...+150 V  
-  
450 g  
68 x 69 x 40 mm  
17 mm  
50 mm M4  
1m (39 inches)  
LEMO

100  $\mu\text{m}$   
1.7  $\mu\text{F}$   
680 / 750 / 580 Hz  
5 N  
0.5 N/ $\mu\text{m}$   
-20°C to 80°C

2  
 $\pm 2.5$  mrad  
center of the stage, 4.5 mm below top plate  
0.85  $\mu\text{F}$   
vacuum, low temperature option

#### **T-450-01\***

-10...+150 V  
strain gauge  
450 g  
68 x 69 x 40 mm  
17 mm  
50 mm M4  
1m (39 inches)  
LEMO

100  $\mu\text{m}$  (80  $\mu\text{m}$ \*)  
1.7  $\mu\text{F}$   
680 / 750 / 580 Hz  
5 N  
0.5 N/ $\mu\text{m}$   
-20°C to 80°C

\* closed loop version; \*\* small signal value  
Please note: additional information for dynamical use after request.

## Nano Positioning System TRITOR 400 / 400 CAP

- motion up to 400  $\mu\text{m}$  per axis
- high resonant frequency
- max. load 50 N
- free hole 19 mm

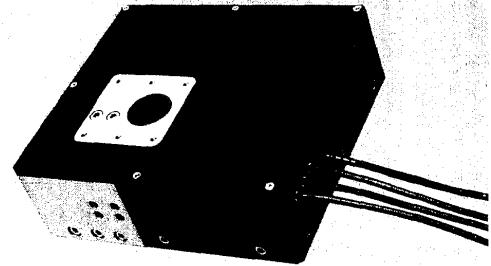

New in the family of well-known compact, multi-dimensional translation stages TRITOR is the serie TRITOR 400 and TRITOR 400 CAP. The TRITOR 400 was designed for large, highly parallel motion (up to 400  $\mu\text{m}$ ) in all three axes. Potential applications for this system include: optics and laser tuning, fiber positioning, micro-positioning and scanning. The TRITOR 400 incorporates a highly compact design, parallel motion due to its parallelogram design, and high reliability because of the solid state hinges. Due to its capacitive measurement system (CAP), the PX 400 CAP translation stage offers resolutions in the low nm range. As an option, all TRITOR 400 may be specially prepared for vacuum and/or low temperature applications.

All TRITOR stages consist of actuators integrated into a housing with an internal lever transmission. This housing is constructed of stainless steel, in combination with anodized aluminum, which results in a rugged yet highly compact design.

Selected components can be mounted on the top plate by four tapped holes and can be accurately located by using the precision pin holes.

### technical data

part. no.:	TRITOR 400 T-406-00	TRITOR 400 CAP T-406-06
motion x,y,z ( $\pm 10\%$ )	400 $\mu\text{m}$	400 / 320 $\mu\text{m}$ (open/closed loop)
integrated measurement system	-	capacitive
operating voltage	-10...+150 V	-10...+150 V
resolution	0.53 nm*	1 nm
capacitance each axis ( $\pm 20\%$ )	14 $\mu\text{F}$	14 $\mu\text{F}$
max. load (statical use)	10 N	10 N
temperature range	-20°C bis 80°C	-20°C bis 80°C
connector	LEMO	LEMO
cable length	1 m	1 m
dimensions (length x width x height)	116 x 106 x 40 mm	116 x 106 x 40 mm
free center space	19 mm	19 mm
thread pattern	32 mm x 32 mm M3x6	32 mm x 32 mm M3x6

#### options

vacuum option, low temperature option

\*measured with E-103-18 amplifier

## Fiberswitch Multimode 1x1 to 1x2; 1x3 to 1x9

The simplest way for the creation of optical fiber switches is to achieve a direct movement of the optical fiber ends with respect to each other. Piezoelectric actuators are ideal candidates for this purpose due to their typical movement ranges and actuation speed. In order to exclude the influences of hysteresis and creep on the accuracy of such a switch, the actuator end positions can be fixed by special stopping configurations. In the case of multimode fibers, the required accuracy (10 microns or more depending on the fiber core diameter) can be achieved by different approaches of precision engineering.

Multimode fiber switches are used mainly in optical metrology applications and optical quality control systems. They are ideally suited to combine up to 9 measurement points with only one spectrometer. Therefore, the end-user derives a cost benefit, and is able to directly compare different optical channels using only one measurement equipment.

- fast switching time
- low insertion loss
- high optical isolation
- compact design
- no additional wavelength dependence

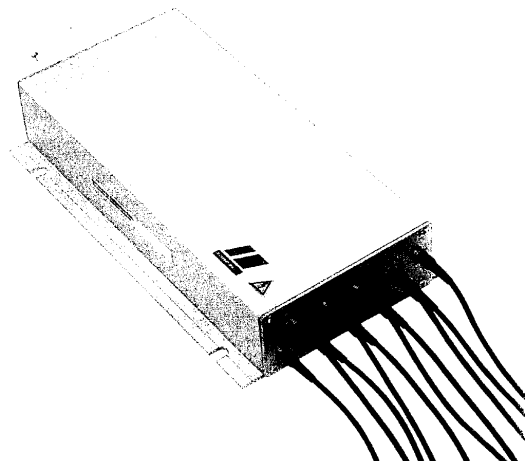

### technical data

#### OPTICAL CHARACTERISTICS

insertion loss	typ.* 0.7 dB (max. 1.2 dB) for 1 x 1 to 1 x 3 switch
	typ.* 1.4 dB (max. 1.8 dB) for 1 x 4 to 1 x 9 switch
cross talk	typ.* -60 dB (max. -55 dB)
repeatability (1000 cycles over 2h)	typ.* 0.02 dB (max. 0.03 dB)

#### TECHNICAL CHARACTERISTICS

switching time	typ. 2 ms (max. 3 ms)
lifetime	10.000.000 cycles
operating temperature	0°C to 60°C
storage temperature range	-40 to +80°C
humidity	55 % RH, >55 % RH-special version

#### ELECTRICAL CHARACTERISTICS

operating voltage	5 V DC / 7-12 V DC**
power consumption	100 mA (f = 0 Hz 50 mA ; f = 50 Hz 300 mA)
control signal	binary code (BCD) / 5 V - TTL

\* depends on fiber core diameter  
 \*\* 1x1, 1x2, 1x3 to 1x9

### types of switches

no. of channels	part no.	housing L/B/H	fiber core diameter
1 x 1	F-101-04	85/105/44 mm	< 100/140 µm
	F-101-04	85/105/44 mm	200/220 µm
	F-101-05	175/105/44 mm	400/440 µm
	F-101-05	175/105/44 mm	600/660 µm
1 x 2	F-102-04	85/105/44 mm	< 100/140 µm
	F-102-05	175/105/44 mm	200/220 µm
	F-102-05	175/105/44 mm	400/440 µm
	F-102-05	175/105/44 mm	600/660 µm
1 x 3	F-103-05	175/105/44 mm	< 100/140 µm
	F-103-03	225/105/44 mm	200/220 µm
1 x 4	F-104-05	175/105/44 mm	< 100/140 µm
	F-104-03	225/105/44 mm	200/220 µm
1 x 6	F-106-05	175/105/44 mm	< 100/140 µm
	F-106-03	225/105/44 mm	200/220 µm
1 x 9	F-109-05	175/105/44 mm	< 100/140 µm
	F-109-03	225/105/44 mm	200/220 µm

### ordering instructions

Please note: when ordering you will need the part number of the switch and also the part no. of the fiber (which includes the optical connector). For each switch you need one input fiber and various numbers of output fibers depending on the switching channels. All fibers must be assembled with a connector, otherwise piezosystem jena can not determine the optical parameters of insertion loss and back reflection. For custom configuration, piezosystem jena retains the right to cancel an order if unforeseen additional efforts are needed which may cause the cost of the systems to exceed the quoted cost. This is related especially to special fiber types piezosystem jena has never worked with or which are supplied by our customers. Standard fiber length will be 1m (±15%). Cost for additional fiber length will be added.

piezosystem jena is using the following types of fibers and connectors for all standard applications:

fiber [µm]		index-profile	numerical aperture	wavelength range	part no. for fiber (without optical connector)
core	cladding				
50	125	graded-index	0.22	850/1300 nm	C-319-*
62,5	125	graded-index	0.28	850/1300 nm	C-329-*
100	140	graded-index	0.29	850/1300 nm	C-339-*
100	110	step-index	0.22	180-1100 nm	C-230-*
100	140	step-index	0.22	350-2600 nm	C-130-*
200	220	step-index	0.22	350-2600 nm	C-140-*
200	220	step-index	0.22	180-1100 nm	C-240-*
400	440	step-index	0.22	350-2600 nm	C-160-*
400	440	step-index	0.22	180-1100 nm	C-260-*
600	660	step-index	0.22	350-2600 nm	C-180-*
600	660	step-index	0.22	180-1100 nm	C-280-*

\* when ordering please use the end number of the optical connectors as follows:

ST = end number -10; SMA = end number -20; FC/PC = end number -30; FC/APC = end number -50

Additional fiber extension or a reduction of fiber length available on request.

## MICI 180 + Micrometer Stages (application sample)

- motion: 180  $\mu\text{m}$
- parallelogram construction allows to increase the resolution of micrometer screw driven stages
- integrated strain gauge measurement system

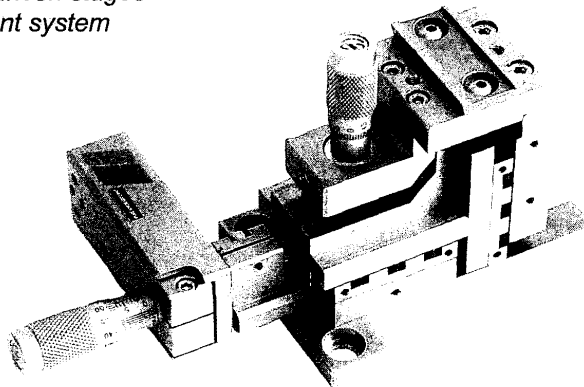

picture: MICI 180 mounted on a standard Newport stage. Additional modifications of the stage are not necessary.

This element was developed for quality control in the optical industry.  
The piezostage is joined with micrometer drives to be mounted into a micrometer positioning system.  
At first the position of the actuator can be adjusted by the micrometer drive and then this position can be fine-tuned with the aid of the piezostage.  
The resolution is in the nm and sub-nm range.

### technical data

part no.	S-704-00	S-704-01
motion ( $\pm 10\%$ )	180 $\mu\text{m}$	150 $\mu\text{m}$
operating voltage	-10 ... +150 V	-10 ... +150 V
capacitance ( $\pm 20\%$ )	1.7 $\mu\text{F}$	1.7 $\mu\text{F}$
resolution	0.1 nm (open loop)*	2 nm (closed loop)**
temperature range:	-20 to 80 °C	-20 to 80 °C
connector:	LEMO	LEMO
length of cable:	1 m	1 m

\* measured with E-100-18 amplifier  
\*\* measured with E-240-100 amplifier

**NV 40 / 1 CL**  
*voltage amplifier with integrated  
 strain gauge measurement  
 amplifier and PID controller*

**12 V 40**  
*OEM voltage amplifier  
 input voltage 12V / 24V*

- stand alone casing
- compact dimensions
- excellent cost effectiveness
- low noise amplifier (0.25 mV RMS)
- RS 232 interface

- compact size
- 12 V or 24 V power supply
- excellent cost effectiveness
- small dimensions

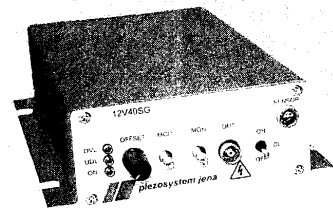
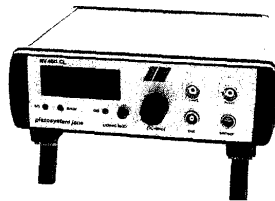

The module **NV40 / 1 CL** was especially developed for low voltage piezoelements equipped with strain gauge sensors. By using the analog input the amplifier can control by an analog voltage of 0...+10V. There is also a BNC socket to control the output voltage. Special circuits suppress voltage peaks to avoid damage of the actuator. The system has very low noise characteristics of less than 0.25 mV RMS and thus provides resolutions in the sub-nm range. The closed loop system will be realized by an integrated PID controller. Please note the compact dimensions of the amplifier!

The voltage amplifier **12V40** is well suited for low voltage piezo elements. Two different types of casing are available. The amplifier requires only 12 V DC or 24 V DC for supply. The amplifier can be controlled via MOD input (front- or backside). The output voltage can be supervised on the monitor output. Special circuits are integrated to protect the piezo element from voltage peaks and excessive voltages. Due to very low voltage noise of only 0.3 mV RMS this amplifier is well suited for sub-nm positioning tasks. All sockets are also available on the backside so this amplifier can be easily integrated as an OEM-product.

technical data

<b>part number:</b>	<b>E-101-53</b> <b>(E-101-54 for 110V)</b>	<b>article-no. E-440-011 (12 V, screw slot casing)</b> <b>article-no. E-440-012 (12 V, plug in casing)</b>
output power	6 W	6 W
output voltage	-10...+150 V	-10...+150 V
output current (permanent)	40 mA	40 mA
noise	0.25 mV RMS	0.3 mV RMS
main supply	220 / 110 V	12 / 24 V
modulation voltage	0...10 V BNC	0...10 V SMB / 0...10 V (back)
input resistance	10 kOhm	10 kOhm
DC offset	adjustable by a 10 turn potentiometer	3/4 turn potentiometer
display	LCD: 4 digits	without
output connector	LEMO	LEMO
monitor output	0...10 V BNC	-1...15V SMB (front), 0...10V (back)
inner resistance (modulation output)	100 kOhm	100 kOhm
dimensions (l x w x h)	200 x 170 x 70 mm	181 x 130/105 x 45 mm
specials	overload protection (OVL) closed loop operation by push button	turn on delay, overdrive protection (UDL/OVL) also available with measuring system and closed-loop operation





## Platines de micro-positionnements motorisées

WT-120 / WT-90	
	Débattement angulaire: 90° Résolution BF: jusqu'à 0,000087° Répétabilité: jusqu'à +/- 0,00022° Charge max.: 20Kg
<b>Appli. Lasers - radiotechnologies - mesures - version vide</b>	

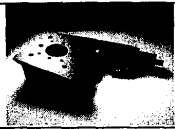
MP-20	
	Course: de 12,5 à 75mm Résolution BF: jusqu'à 0,0055µm Répétabilité uni-dir.: +/- 0,1µm Vitesse max.: 20mm/sec Force max.: 125N
<b>Micro-vérins - Version vide</b>	

WT-100 / WT-85	
	Débattement angulaire: 10° Résolution BF: jusqu'à 0,000087° Répétabilité: jusqu'à +/- 0,000087° Charge max.: 2Kg
<b>Appli. Lasers - radiotechnologies - mesures - version vide</b>	

UPS-150	
	Course: 55 à 305mm Résolution BF: jusqu'à 0,005µm Répétabilité: +/- 0,1µm Vitesse: jusqu'à 600mm/sec Charge max.: 50Kg
<b>Ultra Hte Précision, Moteur Linéaire haute dynamique</b>	

CS-430	
	Course: 350 x 300mm Résolution BF: jusqu'à 0,1µm Répétabilité: +/- 0,2µm Vitesse: jusqu'à 100mm/sec Charge max.: 30Kg
<b>X/Y de Précision pour tests, contrôles - Version vide.</b>	

LMS-110 / LMS-180 / LMS-300	
	Course: 25 à 815mm Résolution: jusqu'à 0,08µm Répétabilité: +/- 0,2µm Vitesse: jusqu'à 800mm/sec Charge max.: 10 / 100 / 200 Kg
<b>Moteur Linéaire haute dynamique</b>	

MS-8 / MS-4	
	Course: 205x205 ou 102x102 mm Résolution BF: jusqu'à 0,1µm Répétabilité: +/- 0,2µm Vitesse: jusqu'à 90mm/sec Charge max.: 8Kg
<b>Table de scannérisation - Version vide</b>	

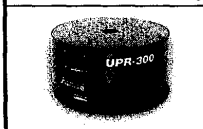
UPR-160 / UPR-300	
	Résolution BF: jusqu'à 0,0001° Répétabilité: +/- 0,0001° Précision absolu: +/- 0,0014° Vitesse: jusqu'à 720°/sec Charge max.: 50Kg
<b>Entrainement Direct (brushless) - version avec Coussin d'Air</b>	

MT-60 / MT-55 / MT-40	
	Course: 5 / 10 / 25 / 40 mm Résolution BF: jusqu'à 0,0055µm Répétabilité: +/- 2µm Précision absolu: +/- 5 à 8µm / 5mm Charge max.: 0,8 / 1 / 1,5Kg
<b>Micro-positionneurs - fibres - diodes lasers - ect...</b>	

## CONTROLEURS

MTS-70	
	Course: 10mm Résolution BF: jusqu'à 0,1µm Répétabilité: +/- 0,2µm Précision absolu: +/- 0,6µm / 10mm Charge max.: 3Kg
<b>Micro-positionneurs Ultra Compact - Version Vide</b>	

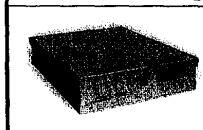
SMC / DMC / MoCo	
	Nb d'axes: jusqu'à 8 axes Cde: P/P, DC, Brushless, Linéaire Communication: RS-232/Ethernet TCP-IP/GPIB/ISA-Bus Interpolation linéaire / circulaire
<b>Joystick (avec afficheur) - écran tactile - E/S - etc...</b>	

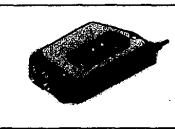
NP-40	
	Course: 25mm Résolution BF: 0,1µm Répétabilité: +/- 0,2µm Vitesse max.: 25mm/sec Force max.: 20N
<b>Nano-Vérin - applications fibres</b>	

PCI / PXI	
	Nb d'axes: jusqu'à 4 axes Cde: P/P, Servo Communication: PCI Bus ou PXI Bus Interpolation linéaire / circulaire
<b>PARTENARIAT MOTION CONTROL</b>	







## Platines de micro-positionnements motorisées

HEXAPODE PAROS	
	6 degrés de liberté courses: 350x350x80mm T(x/y/z) 40° R(x/y) - 100° Rz charge max.: 150 Kg LabVIEW-C++
<i>Version Vide</i>	

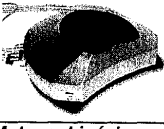
MT-85	
	Course: 52 à 102mm Résolution BF: jusqu'à 0,1µm Répétabilité: +/- 0,2µm Charge max.: 20Kg
<i>Translation de précision - Version vide</i>	

HEXAPODE SpaceFab	
	6 degrés de liberté courses: 25x25x12,7mm T(x/y/z) 10° R(x/y/z) résolution jusqu'à 20nm LabVIEW-Delphi-C++ /com, TCP/IP
<i>Moteurs Linéaires - Align fibre - laser - etc...</i>	

MT-65	
	Course: 26 à 50mm Résolution BF: jusqu'à 0,1µm Répétabilité: +/- 0,2µm Vitesse: jusqu'à 60mm/sec Charge max.: 16Kg
<i>Translation pour micro systèmes diodes lasers - version vide</i>	

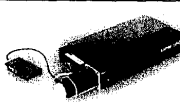
UPM-160	
	Course: 55 à 205mm Résolution BF: jusqu'à 0,005µm Répétabilité: +/- 0,1µm Charge max.: 100Kg
<i>Translation Ultra Haute Précision - Version vide</i>	

VT-80	
	Course: 25 à 300mm Résolution: jusqu'à 0,5µm Répétabilité Uni.Dir.: +/- 15µm Vitesse: jusqu'à 35mm/sec Charge max.: 8Kg
<i>Version économique - Version vide</i>	

UPL-160 / NPE-200	
	Course: 25,4mm / 12,7mm Résolution BF: jusqu'à 0,002µm Répétabilité: +/- 0,1µm Charge max.: 30Kg
<i>Elévation Ultra Haute Précision - Version vide</i>	

HT-90	
	Course: 10mm et 25mm Résolution BF: jusqu'à 0,1µm Répétabilité: +/- 0,2µm Charge max.: 5Kg
<i>Unité d'élévation économique</i>	

HPS-170	
	Course: 52 à 305mm Résolution BF: jusqu'à 0,1µm Répétabilité: +/- 0,2µm Vitesse: jusqu'à 60mm/sec Charge max.: 85Kg
<i>Translation de haute précision</i>	

DT-120	
	Résolution BF: jusqu'à 0,000526° Répétabilité: +/- 0,005° Vitesse: jusqu'à 50°/sec Charge max.: 200Kg
<i>Haute précision - controle vision - laser - version vide</i>	

LS-180	
	Course: 155 à 408mm Résolution BF: jusqu'à 0,1µm Répétabilité: +/- 0,2µm Vitesse: jusqu'à 120mm/sec Charge max.: 100Kg
<i>Translation Haute précision - Lasers industriels</i>	

DT-65N / DT-80	
	Résolution BF: jusqu'à 0,001° Répétabilité: +/- 0,002° Vitesse: jusqu'à 45°/sec Charge max.: 5Kg
<i>Unité de rotation économique, Version vide.</i>	

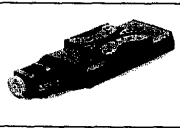
LS-110	
	Course: 26 à 155mm Résolution BF: jusqu'à 0,1µm Répétabilité: +/- 0,2µm Vitesse: jusqu'à 90mm/sec Charge max.: 10Kg
<i>Translation Haute précision - Version vide - Lasers industr.</i>	

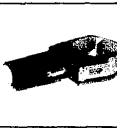
PRS-110	
	Résolution BF: jusqu'à 0,0002° Répétabilité: +/- 0,0002° Vitesse: jusqu'à 200°/sec Charge max.: 10Kg
<i>Unité de rotation d'Ultra Hte Précision - Version vide, cryo.</i>	

## Long-Travel and High Load Motorized Actuators

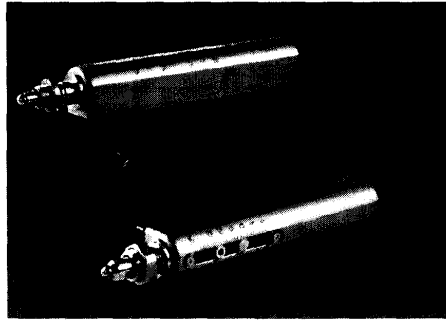

**NEW**  
FROM NEWPORT

### Key Features

- Up to 50 mm travel in a space saving design
- Non-rotating tip improves motion smoothness and has no wear
- Exceptional position sensitivity provided by low-friction design and ultra-high resolution encoder feedback
- Adjustable limit switch prevents damage from over-travel
- Convenient manual positioning knob

The LTA actuators are the successor of our popular 850G and VM series and provide up to 50 mm motorized travel in a compact package. LTAs are designed to fit into your existing manual stages and other opto-mechanical components as a direct replacement for manual micrometers.

The LTA series features a space-saving design with the motor and lead screw side-by-side. This reduces the actuator length by 50% and minimizes the negative effects of long cantilever loads on micro-positioning equipment. The non-rotating tip prevents wear and avoids periodic motion variations which can be caused by variable contact made between a rotating tip and the mating surface.

Precision motion is accomplished by a miniature DC servo motor with an optimized output torque. This allows for faster motion with higher load capacity. The LTA-HL is recommended for heavy load applications.

It features a strong, 8 mm diameter rod and a M12-0.5 mounting bezel that is compatible with our (M-)UMR8 and (M-)MVN80 linear stages and SK and SL series optical mounts. The LTA-HS is optimized for high-speed applications and provides the longer travel range. The mounting interface of the LTA-HS is compatible with a large number of Newport and others manual components.

A movable limit switch prevents equipment from over-travel. The switches position can be changed in minutes to adjust the maximum travel position. A manual adjustment knob permits quick positioning of the actuator while the motor is off. Convenient laser marked scales indicate coarse actuator position in both millimeters and inches.

  
**Newport.**  
Experience | Solutions

## Design Details

Base Material	Stainless steel body with aluminum cover
Drive mechanism	Non-rotating lead screw (rotating nut)
Drive screw pitch (mm)	1.0
Reduction gear	LTA-HS: 1:14 LTA-HL: 1:66
Feedback	Motor mounted rotary encoder, 2,048 cts/rev.
Limit switches	Mechanical switches, both ends, max. travel limit is adjustable
Origin	Uses min. travel limit for homing, typically <20 µm repeatability
Motor	DC-servo motor UE1724SR
Cable length (m)	3
Vacuum compatibility	Vacuum compatible versions are available up to 10 <sup>-6</sup> Torr
MTBF	10,000 h at 25 N load and a 10% duty cycle
Weight	LTA-HS: 0.38 kg LTA-HL: 0.41 kg

## Motion Controller Options

For optimum performance and seamless compatibility, we recommend using one of the following Motion Controllers/Drivers:

XPS



ESP6000 with UNIDRIV6000



ESP300



ESP100



## Specifications

Caution: Values in the table below are indicated for actuators operating with the rod in -Cx direction.

	LTA-HS	LTA-HL
Travel (mm)	50	25
Resolution (µm)	0.035	0.0074
Minimum Incremental Motion (µm)	0.1	0.05
Uni-directional Repeatability (µm) guaranteed	0.5	0.5
Bi-directional Repeatability (µm) <sup>(1)</sup> guaranteed	2	2
On-Axis Accuracy (µm) guaranteed	15	10
Maximum Speed (mm/s)	5	1

<sup>(1)</sup> After backlash compensation: value provided with each actuator.

## Load Characteristics



+Cx Direct Axial Load Capacity (N)  
-Cx Inverse Axial Load Capacity (N)

Caution: To reach the specifications stated for LTA actuators, a minimum axial load must be applied at the end of the rod.

	LTA-HS	LTA-HL
Direct Axial Load Capacity +Cx (N) <sup>(2)</sup>	40	100
Inverse Axial Load Capacity -Cx (N) <sup>(2)</sup>	50	120
Minimum Axial Load Capacity (N)	2.5	5
Side Load Capacity (N) <sup>(3)</sup>	5	20

<sup>(2)</sup> Do not apply alternatively +Cx and -Cx loads during an operating cycle.

<sup>(3)</sup> No side loads during motion.

## Dimensions

### LTA-HL & LTA-HS Actuators

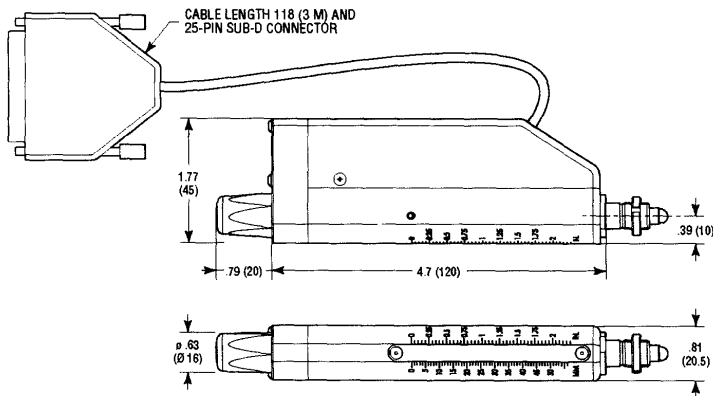
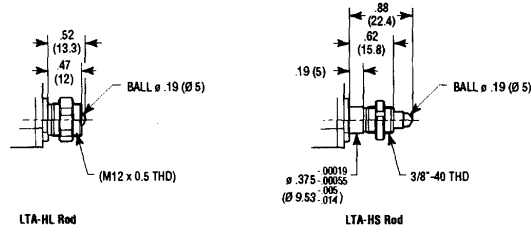

### LTA-M12 Adapter

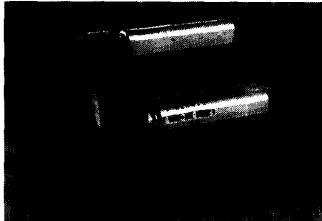
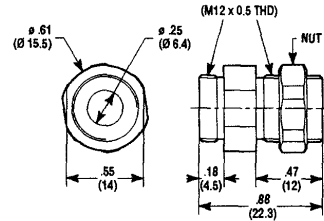

SL mount with LTA actuators.

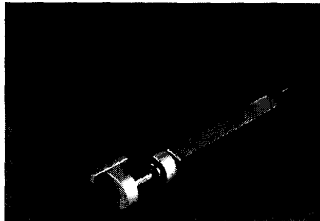

The LTA Series actuator is compatible with most standard Newport manual stages and opto-mechanical components like the M-436 Series translation stage.

## Ordering Information

Description	Model
Motorized actuator, high speed version, 0-50 mm travel	LTA-HS
Motorized actuator, high load version, 0-25 mm travel	LTA-HL
LTA-HS Actuator, vacuum compatible to 10 <sup>-6</sup> Torr *	LTA-HSV6
LTA-HL actuator, vacuum compatible to 10 <sup>-6</sup> Torr *	LTA-HLV6
M12-0.5 mounting adapter for LTA-HS to M-UMR80, M-MVN80, SL and SK products	LTA-M12

\* Available February 2004.



ISO 9001  
No. 2727

Newport Corporation, Irvine, California, has been certified compliant with ISO 9001 by the British Standards Institution.

Belgium	France	Germany	Italy
Newport BV filiaal België	MICRO-CONTROLE	Newport GmbH	Newport/Micro-Controle Italia
Tel +32-(0)11 6402927	Tel +33-(0)1-60-91-68-68	Tel +49-(0)6151 / 3621-0	Tel +39-(0)2-929-0921
Fax +32-(0)11 6402227	Fax +33-(0)1-60-91-68-69	Fax +49-(0)6151 / 3621-52	Fax +39-(0)2-923-2448
<b>Netherlands</b>	<b>Sweden/Denmark</b>	<b>United Kingdom/Ireland</b>	
Newport B.V.	NPT Instruments AB	Newport Ltd.	
Tel +31-(0)30 6592111	Tel +46-(0) 8591 18844	Tel +44-(0)1635 521757	
Fax +31-(0)30 6592130	Fax +46-(0) 859440423	Fax +44-(0)1635 521348	

Visit Newport Online at [www.newport.com](http://www.newport.com)

LTA-DS (10/03)

## Integrated Motion Controller/Driver System

Preliminary  
Data Sheet

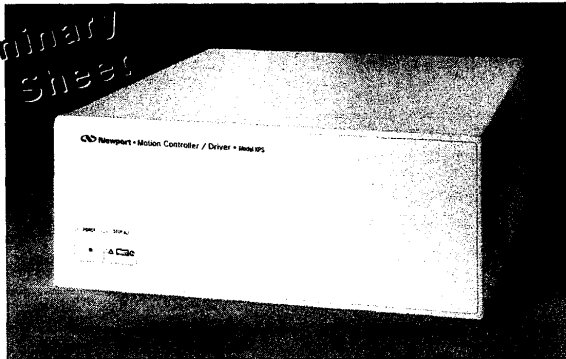

Newport's XPS is a high-performance, integrated motion controller/driver system offering outstanding trajectory accuracy and exceptional programming functionality. It combines operational simplicity with advanced features to precisely control the most diverse motion sequences and synchronize them via measurement, command, or external data acquisition tools. Furthermore, sporting a real-time, multi-tasking functionality, XPS can also operate as a process controller to run your application.

XPS supports any Newport positioner and many other motion devices, whether they use stepper, DC brush, DC brushless rotary or linear, voice coil or piezoelectric actuation.

A unique motion profiler auto-adapts the jerk time depending on move distance and greatly reduces the excitation of the system's mechanical resonances and stress, resulting in faster settling, more accurate trajectories and a longer life time—all that without sacrificing the move time.

XPS is based on a 10/100 Base-T Ethernet communication link with TCP/IP protocol and uses a web site approach for all software tools and FTP for data transfer. This makes it almost independent from the operating system of the user. When networked, Unix-, Linux-, or Windows-users can access the same controller from any place in the world for remote control, code development, data transfer or diagnostics.

XPS also excels as a process controller for running your applications. Based on a real-time, multi-tasking functionality, XPS is able to execute user-defined applications in real time on the motion controller using TCL scripts.

For applications that require analog data analysis in exact relation to the position, XPS's gathering mode captures all important axis information and I/O's with a time jitter of less than 50 ns, storing data in a custom-configured table.

### Key Features

- High performance, 1-8 axes motion controller/driver
- High-speed 10/100 Base-T Ethernet communication interface, typ. 0.3 ms command execution
- TCP/IP communication protocol allows for multi-tasking and multi-user applications from most operating systems: e.g. Unix, Linux, and Windows
- Powerful, intuitive and object-oriented command language with multi-parameter API's
- Highly developed motion trajectories including continuous path contouring, splines and PVT mode
- Advanced servo loop with variable PID's, low-pass and notch filters
- Broad range of compensation features including 3D mapping
- Hardware position latch and position compare output for exact synchronization with less than 50 ns latency
- Extensive I/O functionalities including four uncommitted analog inputs, four uncommitted analog outputs and 30 TTL in- and outputs
- High-speed data acquisition at up to 10 kHz rate
- Complete library of LabView VI's
- P4 2 GHz motion processor manages various important tasks

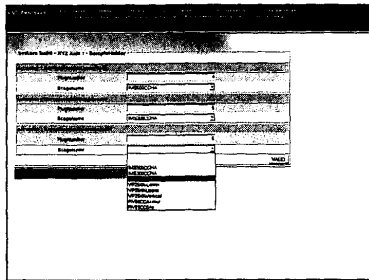

XPS controller configuration is supported by a convenient software tool. When used with Newport stages, all settings can be made in just a few clicks.

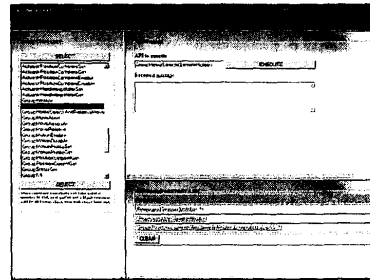

The command screen lists all APIs by groups, including all necessary or available parameters. It is a convenient tool to learn the XPS syntax, allowing for simple programming, code testing and debugging.

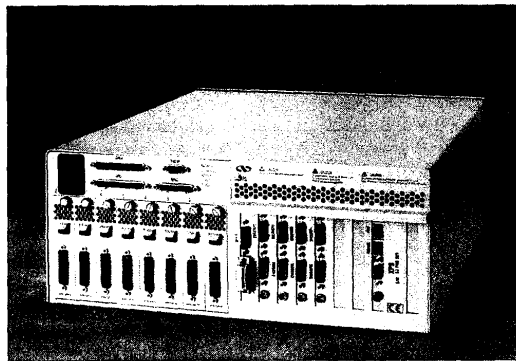

ISO 9001  
PM 07207

Newport Corporation, Irvine, California, has been certified compliant with ISO 9001 by the British Standards Institution.

**Belgium**  
Newport BV filiaal België  
Tel: +32-(0)11 6402927  
Fax: +32-(0)11 6402227

**Netherlands**  
Newport B.V.  
Tel: +31-(0)30 6592111  
Fax: +31-(0)30 6592120

**France**  
MICRO-CONTROLE  
Tel.: +33-(0)1-60-91-68-68  
Fax: +33-(0)1-60-91-68-69

**Sweden/Denmark**  
NPT Instruments AB  
Tel.: +46-(0) 859118844  
Fax: +46-(0) 859440423

**Germany**  
Newport GmbH  
Tel.: +49-(0)6151 / 3621-0  
Fax: +49-(0)6151 / 3621-52

**United Kingdom/Ireland**  
Newport Ltd.  
Tel.: +44-(0)1635 521757  
Fax: +44-(0)1635 521348

**Italy**  
Newport/Micro-Controle Italia  
Tel.: +39-(0)2-929-0921  
Fax: +39-(0)2-923-2448

Visit Newport Online at [www.newport.com](http://www.newport.com)  
XPS-DS (10/03)

# NAIS



Quality control by...

Contrôle de la qualité par.

Imagechecker

**Machine Vision Systems in the  
packing and food industries**

**Systèmes de vision pour les secteurs  
de l'emballage et de l'agroalimentaire**

*Smart Solutions by NAIS\**

\* Les solutions intelligentes de NAIS



## **About this booklet ...**

This booklet from Matsushita shows you just a few possibilities to check the quality of products by machine vision systems.

Matsushita offers a large range of machine vision systems adapted to different applications : the systems A100 and A200 with their compact size and multifunctional performance, the M100 and M200 series for special applications such as character verification and high speed measurement and the P400 system for very complex applications with up to nine cameras.

The philosophy of parametrical systems is valid for all Matsushita machine vision systems.

### **What are Imagecheckers ?**

It is a camera based on image checking system. This means each product manufacture, assembled, packed or printed on a production line will be photographed and the image will be analysed. Depending on parameters defined with a „good“ product, the calculator can determine if a product is conform or not. In the case of no conformity the Imagechecker will send a signal that permits to eject automatically all no conform products. The time between a picture taken and the indication of a no conform product can go down to 20 ms. In other words, even 3000 products per minute or 180,000 products per hour can be checked. Of course the more criteria you will observe on your product, the more time the calculator needs.

For your future „IMAGECHECKER“ applications we added a questionnaire on the last page which will help us to carry out feasibility tests with your samples.

## **Dans cette brochure**

*Dans cette brochure Matsushita, vous trouverez quelques exemples de vérification de la qualité des produits grâce à ses systèmes de vision industrielle.*

*Matsushita offre une large gamme de systèmes de vision adaptés à des applications diverses : la série des Imagechecker A100 et A200, multifonctions et de taille compacte ; la série M100 et M200 pour des applications spéciales telles que la vérification des caractères ou la mesure à grande vitesse et enfin le système P400 pour des applications très complexes.*

### **Qu'est-ce qu'un „Imagechecker“?**

*C'est un système de contrôle d'images par caméra. Chaque produit fabriqué sur une ligne de production est pris en photo et l'image est analysée. Dépendant de paramètres définis avec un produit „bon“, l'unité centrale peut déterminer si un produit est conforme ou pas. Dans le cas d'une non conformité, l'Imagechecker va envoyer un signal qui permet d'éjecter automatiquement toutes les pièces non conformes. Le temps entre une prise d'image et l'indication d'une pièce non conforme peut descendre jusqu'à 20 ms. Cela signifie que, 3000 pièces par minute ou 180000 pièces par heure peuvent être contrôlées. Bien sûr plus les critères que vous voulez observer sur vos produits sont nombreux, plus le temps de traitement sera long.*

*Pour vos applications „IMAGECHECKER“ vous trouverez à la dernière page, un questionnaire qui nous permettra de réaliser une étude de faisabilité avec vos échantillons.*



# Check of packaging and labels

## Contrôle d'emballage et d'étiquettes

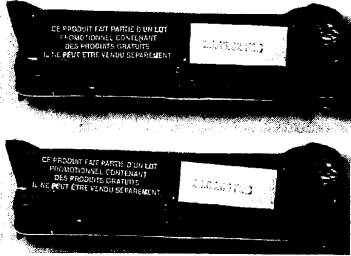

Position check of packing and date printing check on a chocolate bar / *Contrôle de position d'emballage et contrôle de date sur une barre de chocolat*

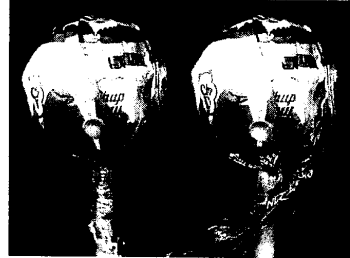

Packing check of lollypops / *Contrôle d'emballage de sucettes*



Position and orientation check of paper before cutting / *Contrôle de position et d'orientation de cartons d'emballage avant découpe*

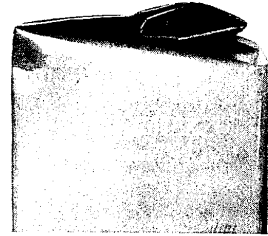

Packaging check of coffee / *Contrôle d'emballage du café*



Position/presence check of labels on ice cream cover / *Contrôle de position / présence d'étiquettes sur des couvercles de boîtes de glace*

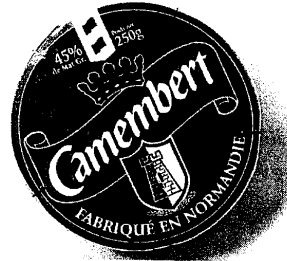

Position and presence check of label / *Contrôle de position de l'étiquette et des agrafes*

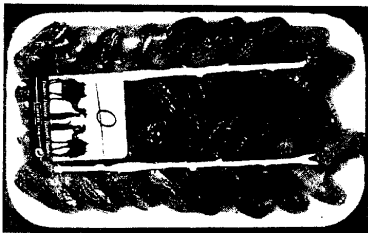

Position / Presence check of label and sticks and of dates on the border of the packing / *Contrôle de position/présence d'étiquettes et de pics et contrôle des dates en bordure de l'emballage*



Position/presence check of a tax label on alcohol bottles / *Contrôle de position/présence de «congés» sur des bouteilles de vin*

## Check of bottle caps *Contrôle de bouchons*



Food can checking (label / cover position)  
*Contrôle des boîtes de conserve (étiquette / position du couvercle)*

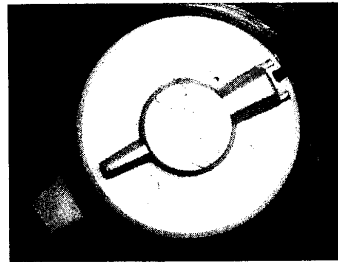

Position control of the salt dispenser position  
*Contrôle de position de clips sur des couvercles de salières*

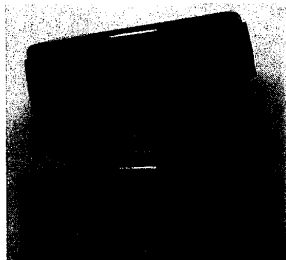

Position check of a cap  
*Contrôle de position d'un bouchon*



Position/presence check of metal holder of champagne cork / *Contrôle de position/présence de la plaque de muselet sur des bouchons de champagne*

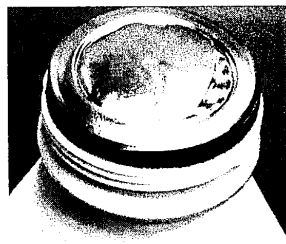

Position check of opercula on milk bottles  
*Contrôle de position d'opercule sur des bouteilles de lait*

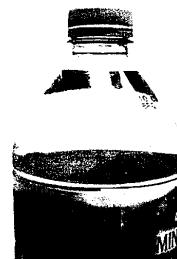

Label, level and cap checking on mineral water bottles  
*Contrôle de position de l'étiquette, du niveau et du bouchon sur des bouteilles d'eau minérale*

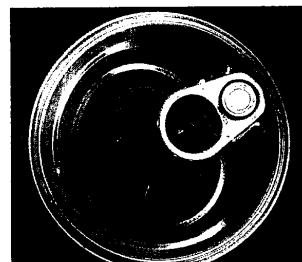

Position indication of an can opening ring  
*Indication de position de l'anneau d'ouverture des boites*



Position and presence check of water bottle cap  
*Contrôle de position et de présence du bouchon sur des bouteilles d'eau*

## Food checking *Contrôle agroalimentaire*

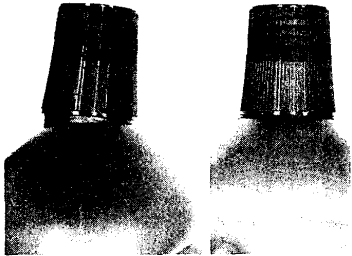

Position check of a cap with two camera  
simultaneously / *Contrôle de position d'un  
bouchon avec deux caméras simultanément*

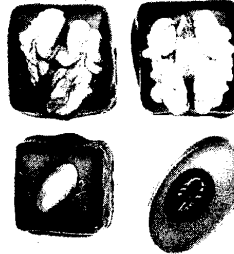

Conformity and dimension check of pralines  
*Contrôle dimensionnel et de conformité  
de chocolats*

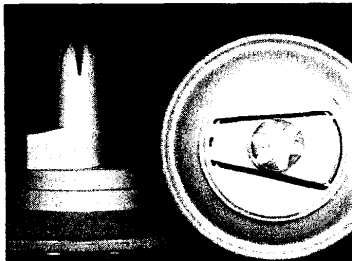

Position and conformity check of a whip-cream  
dispenser / *Contrôle de position et de conformité  
d'une bombe de chantilly*

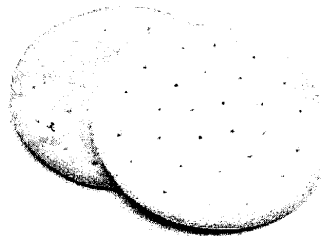

Size and color check of biscuits  
*Contrôle de taille et de couleur de biscuits*

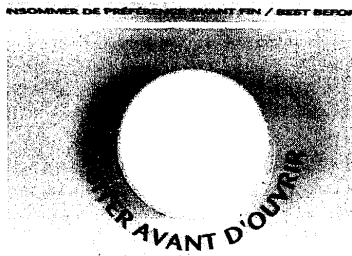

Position check of a screw-able cap  
*Contrôle de position d'un bouchon dévissable*

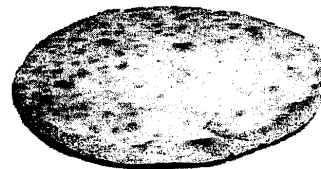

Check size and position of pizzas  
*Contrôle de position et taille de pizzas*

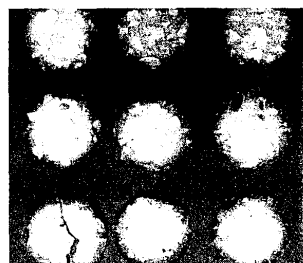

Checking of cakes on the production line  
*Contrôle de gâteaux sur la ligne de production*

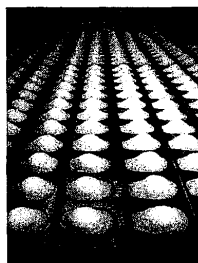

Color and form check of cakes  
*Contrôle de forme et de couleur de madeleines*

## Industrial machine vision systems *Systèmes de vision industrielle*

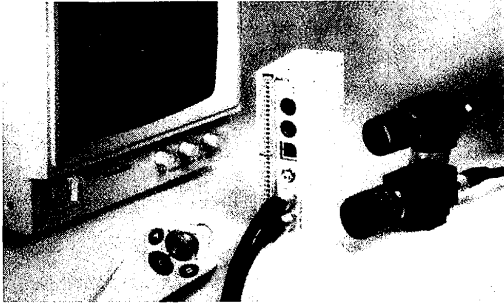

A100 / A200

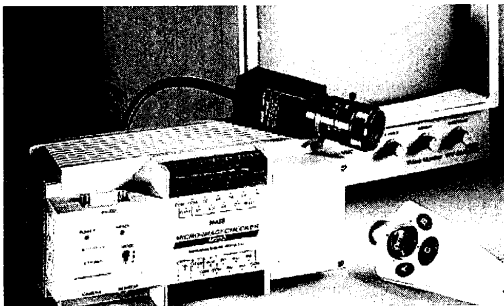

M100 / M200

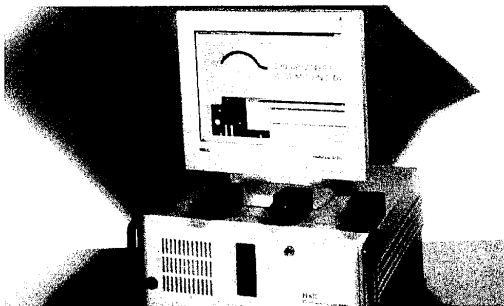

P400

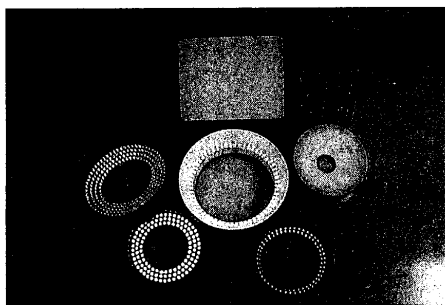

Lighting systems / Systèmes d'éclairage

Matsushita offers a large range of machine vision systems which can respond to your different applications. Our smallest units are the A100 and A200 with a size of 100 mm x 50 mm. They only use a space of 14 mm on the fixing rail in the electrical cabinet and can store up to 96 different types of programs. All parameters can be set with a small keypad.

*Matsushita propose une gamme de systèmes de vision élaborés pour répondre à vos différentes applications. Nos plus petits systèmes sont les A100 et A200 avec des dimensions de seulement 100 mm x 50 mm. Ils n'occupent que 14 mm sur le rail de fixation dans l'armoire électrique. Le A200 peut stocker jusqu'à 96 programmes différents. Tous les paramètres sont définis à l'aide d'une petite console de paramétrage.*

This series offer different program packages for special applications. The package OCV (character verification) for example has been developed to inspect the printing of dates, logos or serial numbers. It can detect missing, incorrect and unreadable printings. The mould watcher package, another special development, prevents a double injection of plastic inside a mould.

*Cette série propose différents programmes pour des applications spécifiques. Le programme OCV (vérification des caractères) par exemple, a été développé pour l'inspection de dates, logos ou numéros de séries. Il peut identifier des caractères manquants, incorrects et illisibles. Le programme „contrôle de moules d'injection plastique“ évite une double injection de plastique dans le moule.*

This is our PC based machine vision system, the most powerful in our range. Up to 9 cameras can be handled on the same system and the number of programs is not limited. You can generate automatically files, indicating the quality of your products and use also high resolution cameras. The NAI's vision software runs under Windows NT on an industrial PC.

*Le P400 est un système de vision basé sur un ordinateur. Jusqu'à neuf caméras peuvent être gérées par le même système et le nombre de programmes n'est pas limité. On peut générer automatiquement des fichiers, indiquant la qualité de vos produits et utiliser des caméras haute résolution. Le logiciel NAI's vision fonctionne sous Windows NT sur un PC industriel.*

Due to the high importance of the light source in most of the machine vision system applications, Matsushita also offers a wide range of different lighting systems. Depending on your application and the test done in our laboratory, we offer back lights or ring lights with high frequency fluorescence and LED lighting in different sizes, colors and forms. Colour and polarised filters are used for getting the best contrast to carry out the optical control.

*La source de lumière étant très importante dans la plupart des applications vision, Matsushita propose une gamme complète de différents systèmes d'éclairage. En fonction de votre application et des tests effectués dans notre laboratoire, nous offrons des éclairages en arrière-plan ou annulaires à haute fréquence ou des lampes à LED de taille, forme et couleur différentes. Des filtres de couleur ou de polarisation sont utilisés pour garantir une image avec un contraste optimal.*

The world's leading CMOS and CCD image sensors, cameras, and components.

# Vision for Machines

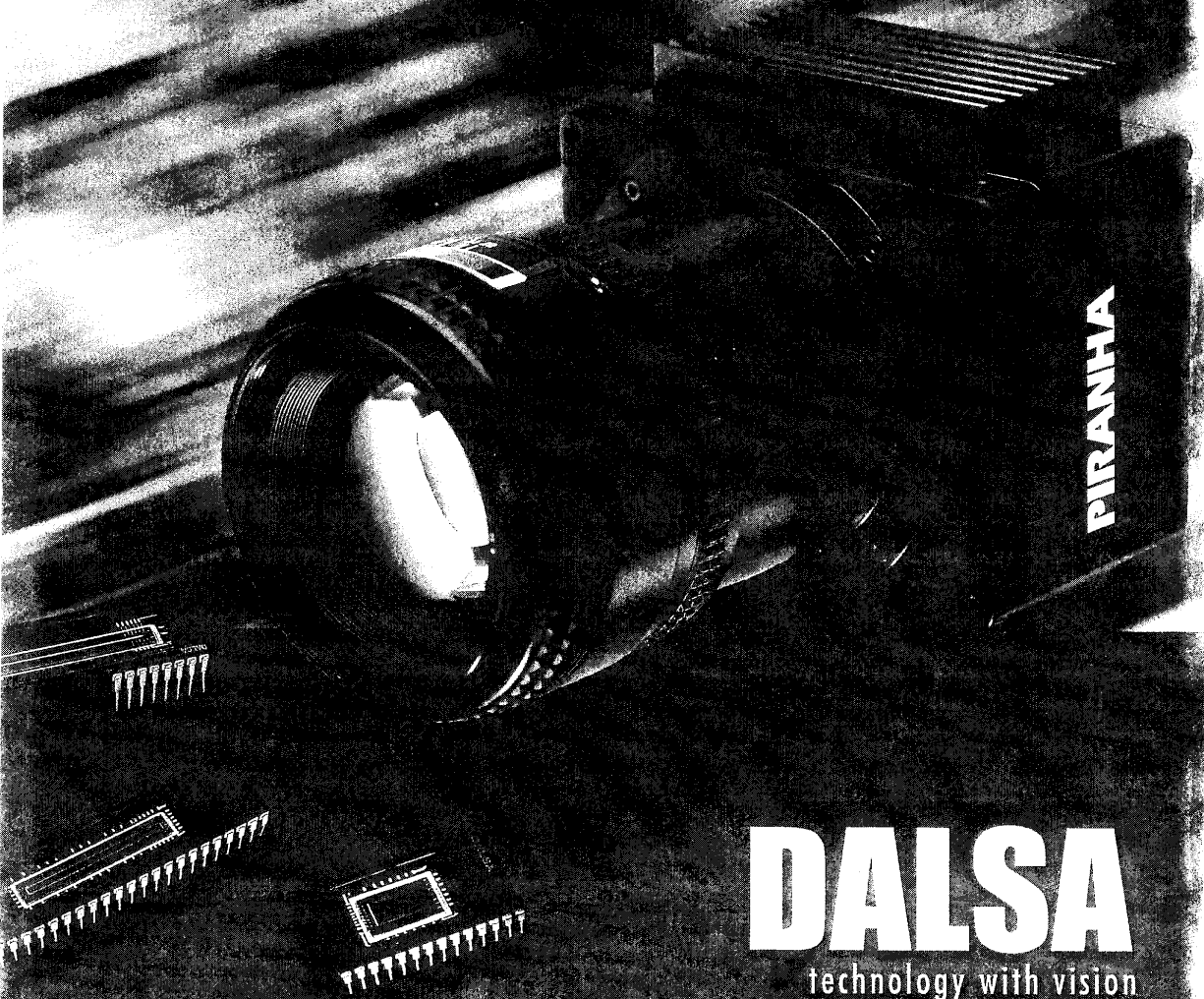

**DALSA**  
technology with vision

# We're passionate about innovation.

Being passionate about innovation has been our formula for success for over 20 years. It's transformed us into one of the largest and most successful companies in the imaging industry. Yet, innovation applies to more than just our products and technology. It's also an important part of how we think and manage our company, and has helped us grow to over 650 employees across seven international locations.

## We push the limits of performance

DALSA has a reputation for leading the industry. For the performance factors that matter most in image capture — speed, resolution, dynamic range, and responsivity — few companies can match our long list of industry firsts:

- 30MHz operation (1985)
- Commercial Time Delay and Integration (TDI) products (1988)
- 25 million pixel devices (1991)
- 1GHz total throughput (1992)
- Scientific quality, mega-pixel camera with real time video rates (1995)
- TDI with antiblooming (1998)
- 8 million pixel 60fps digital cinema device (1999)
- 1200fps VGA CMOS device with non-rolling shutter (2000)
- 19.2Gigabit/sec Camera (2001)

With design groups in Waterloo, Colorado Springs, Tucson and Eindhoven, and a specialized wafer foundry in Bromont, we continue to build on our leadership in innovation. We own dozens of patents for the design of CCD and CMOS image sensor chips and digital camera as well as dozens more for fabricating the semiconductors that drive them. The net result is digital imaging solutions that meet the needs of the imaging industry's most challenging applications.

## We're here for the long term

At DALSA, we pride ourselves on having a strong and resilient foundation and an approach that is focused and deliberate. As a team, we will continue to build on these attributes as we grow in scope, revenues and profitability over the coming years. If you're looking for a strong partner for the long run, insist on a DALSA solution.

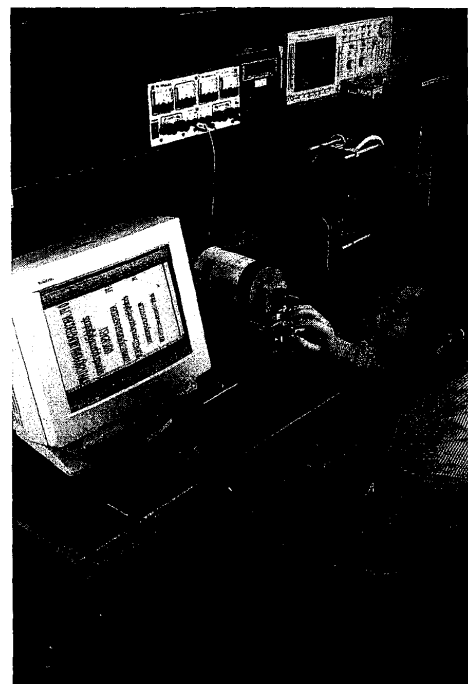





# Line Scan Imaging

**D**ALSA line scan cameras have a strong reputation because they're fast and they're highly responsive. Whether you're inspecting printed circuit boards, scanning documents or reading bar codes, the ability to run at the highest possible line rate without running out of light and still maintaining dynamic range defines the success of your application.

## Faster is definitely better

We recognize your need for speed by offering the industry's fastest line scan cameras. From single output models running at 40MHz to multiple output models running at up to 200MHz, you can count on a DALSA line scan camera to provide the line speed your application needs. Take our **Piranha2** cameras; at a combined data rate of 160MHz, Piranha2 is the fastest standard line scan camera around. It also requires less light than our original Piranha camera, even at these high speeds.

## A brighter idea

Our line scan cameras are the most responsive in the industry. Our **Advanced** line scan and **High Sensitivity** products, for example, are designed to provide up to 100 times more responsivity than comparable standard line scan products — all at the highest possible line rates.

If you're looking for the highest performance with the greatest selection of models, look to DALSA for your next line scan application.

*Piranha2 is the fastest standard line scan camera around with a total data rate of 80/160MHz (2 or 4 outputs). It's also extremely responsive, actually requiring less light than our original Piranha camera, even at a 60% greater data rate.*

## Standard Line Scan

- Data rates to 160MHz
- Line rates up to 79kHz
- Resolutions up to 8192 pixels
- 1 to 4 outputs
- 8 cameras (one with color) and 4 sensor products to choose from

## Advanced Line Scan

- Ultra-high responsivity (up to 100 times that of standard line scan)
- Pixel-by-pixel flat field correction on some models
- Data rates up to 40MHz
- Line rates up to 64.1kHz
- Resolutions up to 2048 pixels
- Single output

## High Sensitivity Line Scan

- Ultra-high responsivity
- Data rates up to 200MHz
- Line rates up to 83kHz
- Resolutions up to 4096 pixels
- 3, 4 and 8 outputs
- 4 cameras (one in color) and 1 sensor product to choose from



# Area Scan Imaging

If you're looking for high performance area scan, we've got it covered — from feature-rich, fast-shuttering megapixel models to scientific quality cameras with true 12-bit dynamic range.

## “Stop Action” for smear-free capture of fast moving objects

For the growing number of applications that require mega+ resolution combined with electronic shuttering capabilities, we're proud to offer the new DALSTAR “Stop Action” family of area cameras. These new cameras are designed to “stop the action” and provide smear-free capture of fast moving objects.

Drawing on the best available CMOS and CCD technologies, DALSTAR “Stop Action” means best in class performance for 100% PCB inspection, industrial metrology, traffic management and robotics. Features include 1024 x 1024, 1600 x 1200 or 1920 x 1080 pixel resolutions with 8 or 10 bit dynamic range and CameraLink™ interface. In select cameras we've included exclusive features such as LINLOG™ response which provides tremendously wide dynamic range (up to 120dB) — perfect for imaging dark scenes with very bright elements, such as in night-time license plate and other traffic management imaging.

## Scientific-grade for superior resolution and ultra-high image fidelity

While the majority of machine vision applications use RS-170/CCIR resolution CCD imagers, a growing number require the superior spatial resolution and higher image fidelity of scientific-grade cameras. Higher resolution, higher speed and higher dynamic range are the keys to success in numerous mission-critical electronics, semiconductor, flat panel, and medical imaging applications. DALSTAR cameras meet this need with mega and multi-mega-pixel resolutions, ultra high speed and true 12-bit dynamic range. DALSTAR cameras truly set the new standard for high performance.

*The DALSTAR 2M30-SA is our newest “Stop Action” area scan camera. At 30 frames per second, it features a two-megapixel interline transfer CCD with either 1600 x 1200 or 1920 x 1080 pixels — twice the resolution of “standard” 1k x 1k cameras.*

## “Stop Action” Electronic Shuttering

- Fast electronic shutter for smear-free image capture
- 1024 x 1024, 1920 x 1080 or 1600 x 1200 pixels
- Up to 75 fps
- 8 or 10 bit
- LINLOG™ and windowing on CMOS models
- 3 cameras (one with color option) and 1 sensor product to choose from

## 8-bit Frame Transfer

- 128 x 128 to 1024 x 1024 pixels
- Up to 955 frames per second
- High Responsivity
- 3 cameras and 1 sensor product to choose from

## 12-bit Frame Transfer/ Full Frame

- 1024 x 1024 to 3072 x 2048 pixels
- True 12 bit dynamic range with CDS
- Up to 30 fps
- 1 to 4 outputs
- 6 cameras (2 with color) to choose from

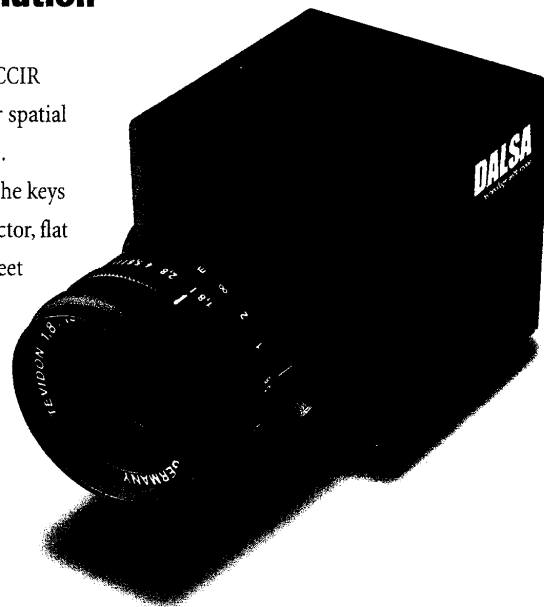

# Products Overview Table

Product Type	Name	Product ID	Strengths	Resolution	Line/Frame Rate	Data Rate
<b>Line Scan Cameras</b>	Piranha	CT-P1	4 O/P, Low Lag Pixels	1024/2048/4096	79/43/23kHz	4x25MHz
	Piranha	CL-P1	2 O/P, Low Lag Pixels	512/1024/2048/4096	79/43/23/11kHz	2x25MHz
	Piranha	CT-P4	High Res, 4 O/P, PPD	6144/8192	15.6/11.8kHz	4x25MHz
	Piranha	CL-P4	High Res, 2 O/P, PPD	6144/8192	7.9/6.0kHz	2x25MHz
	Piranha2	P2-4x	4 O/P, Fast, Hi Res, Compact, Camera Link	4096/6144/8192	36/24/18kHz	4x40MHz
	Piranha2	P2-2x	2 O/P, Fast, Hi Res, Compact, Camera Link	1024/2048/4096/6144/8192	67/36/18/12/9kHz	2x40MHz
	Spyder	SP-14	Compact, Single Power Input	512/1024/2048	67.1/36.1/18.7kHz	40MHz
	Trillium	TR-34	Color Fidelity, Autocalibration	1024/2048	21/11kHz	3x25MHz
<b>Line Scan Sensors</b>	DALSA	IT-P1	4 O/P, 5V clocks, Low Lag Pixels	1024/2048/4096	87.3/46.1/23.7kHz	4x25MHz
	DALSA	IL-P1	2 O/P, 5V clocks, Low Lag Pixels	512/1024/2048/4096	87.3/46.1/23.7/12.0kHz	2x25MHz
	DALSA	IL-P3	Single O/P, PPD, 5V clocks	512/1024/2048	73/37.8/19.2kHz	40MHz
	DALSA	IL-C6	Tall Pixels, High Dynamic Range	2048	7.2kHz	15MHz
<b>Advanced Line Scan Cameras</b>	Eclipse	EC-11	Low Light, High Speed, Compact	512/1024/2048 x 96 TDI	64.1 / 34.8 / 17.4kHz	40MHz
<b>High Sensitivity Line Scan Cameras</b>	DALSA	CT-E4	Low Light, 4 O/P, Antiblooming	2048/4096 x 96 TDI	44/23kHz	4x25MHz
	DALSA	CT-F3	Low Light, 8 O/P, Antiblooming	2048x144/4096x96 TDI	83 / 44kHz	8x25MHz
	DALSA	CT-F6	Low Light, 8 O/P, High Blue Response	2048x96 TDI	44kHz	8x15MHz
	DALSA	CL-T7	Low Light, Color	2048	10kHz	3x25MHz
<b>High Sensitivity Line Scan Sensors</b>	DALSA	IT-F6	Low Light, 8 O/P, High Blue Response	2048x96TDI	50kHz	8x20MHz
<b>Area Scan Cameras</b>	DALSTAR	CA-D1	Single O/P, 12 bit option	128x128	736 fps or 490 fps	15 or 10MHz
	DALSTAR	CA-D6	4 O/P, High Speed, 8 bits	260x260/532x516	955/262fps	4x25MHz
	DALSTAR	1M15	Single O/P, 12bits	1024x1024	15fps	20MHz
	DALSTAR-SA	1M28-SA	CMOS, "Stop Action" Imaging	1024x1024	27fps	1x28MHz
	DALSTAR	1M30	Single O/P, 12bits	1024x1024	30fps	40MHz
	DALSTAR-SA	1M75-SA	CMOS, "Stop Action" Imaging	1024x1024	75fps	2x40MHz
	DALSTAR	CA-D4	1 or 20/P selectable, 8 bits	1024x1024	40fps	1 or 2x25MHz
	DALSTAR-SA	2M30-SA	"Stop Action" Imaging, 10 bits	1600 x 1200/1920 x 1080	30fps	2 x 40MHz
	DALSTAR	4M4	High Resolution, Single OR, 12 bits	2048x2048	4fps	20MHz
	DALSTAR	4M30	High Resolution, 40/P, 12 bits	2048x2048	30fps	4x40MHz
	DALSTAR	6M3	High Resolution, Color Option, 12 bits	3072x2048	2.75fps	20MHz
	DALSTAR	6M18	4 O/P, High Res, High Speed, 12 bits	3072x2048	18fps	4x40MHz
	<b>Area Scan Sensors</b>	DALSA	IA-D1	Frame Transfer	128x128	830/220fps
DALSA		IA-G1	Hi Speed, 16 O/P, CMOS	640x480	1300fps	50MHz per O/P

# DALSA

technology with vision

<http://vfm.dalsa.com>

Nov 2002 - Printed in Canada



Parc Technologique Europarc  
28 - 30 rue Jean Perrin  
33608 PESSAC CEDEX

Tél. : +(33) (0)557 266 901 - Fax : +(33) (0)557 266 899  
e mail : i2s@i2s.fr - www.i2s-vision.fr

Asia/Pacific

DALSA

Space G1 Building, 4F

2-40-2 Ikebukuro

Toshima-ku, Tokyo 171-0014, Japan

Phone: +81 3 5960 6353

Fax: +81 3 5960 6354

E-mail: asia@dalsa.com



e2v technologies continues to lead the world market, supplying high performance Charge Coupled Devices (CCDs) for a broad range of demanding applications. Operating across the electro-magnetic spectrum from X-rays, through ultraviolet and visible light to infrared, our solid-state sensor range includes very large area (VLA) and very high speed (VHS) arrays, alongside a comprehensive range of very low noise (VLN) spectroscopic devices.

Delivered to highly customized or standard designs, our sensors serve space & astronomy, dental, scientific & medical, and industrial markets. Our CCD technology is also extensively qualified in the defense sector.

Over two decades of continued investment, research and development has enabled e2v to break several imaging boundaries to date. Leading-edge technologies, such as L3Vision™, are ensuring that the company's high-end imaging products remain world leaders.

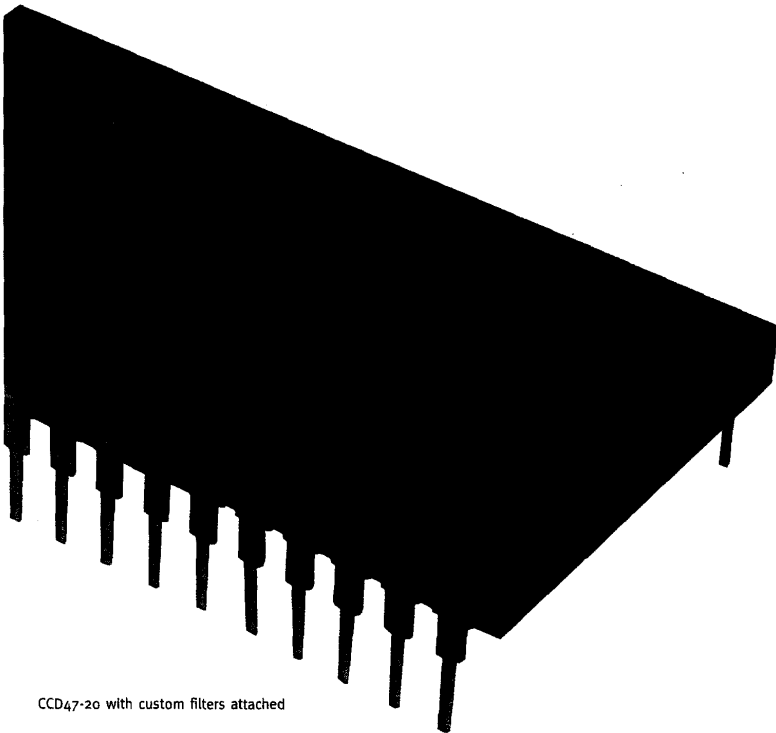

CCD47-20 with custom filters attached

#### **MEDICAL**

As an established supplier of detectors and sub-assemblies, e2v technologies continues to make significant contributions to medical imaging, principally to x-ray and biopsy analysis. Our unique capabilities include:

- Large area sensors
- Proprietary scintillator and phosphor deposition for excellent image quality
- Fiber-optic hard coupling with proven reliability
- High full well, low dark current for high dynamic range
- Readily available applications support

Further developments of our medical imaging capabilities include the introduction of our extreme low light level CCD technology, L3Vision™ (see page 4). L3Vision™ is advancing pre-emptive diagnostic and minimally invasive surgical techniques worldwide.



#### DENTAL

e2v's intra-oral X-ray imaging sensors are revolutionizing the way X-ray images are captured, stored and retrieved in dental offices. Our encapsulated package sensors offer high performance imaging from low radiation doses. Special-to-purpose packaging and X-ray conversion coatings have resulted in a discrete, easy to use sensor with exceptional performance.

For OEMs, we can also offer a driver board for both high and low resolution sensors. e2v technologies' DXDB01 dental driver board has passed certification as a Class 1 device under medical electrical equipment IEC60601 and provides a convenient interface between PC and e2v intra-oral dental sensors. In addition, we can offer a suite of software and detailed documentation to simplify the integration into the OEM application.

#### SCIENTIFIC

Ensuring our customers have the correct CCD for the specific task is a central philosophy at e2v technologies. Our range of standard and custom devices encompasses many state-of-the-art processes and technologies, which results in the scientific community being well served across the application spectrum, including spectroscopy, microscopy and general scientific imaging.

Our CCDs are well suited to biosciences, bioluminescence, chemical fluorescence and drug discovery applications, such as high throughput screening. Several imaging arrays in our portfolio offer low noise readout, high and medium resolution, and formats of 256x256, 512x512, 1kx1k and 2kx2k pixels (please see e2v's CCD Selection Guide for more details). Bioscience applications, such as single molecule fluorescence, have benefited greatly from the improved sensitivity at high speeds that our L3Vision™ technology offers.

High quantum efficiency on back illuminated devices (typically 95% peak), very low noise (2e-rms noise equivalent signal) or high speed (above 35 MHz) are key features of our CCDs. When combined with the options of Inverted Mode Operation/Multi-phase Pinned (IMO/MPP), back thinning and a wide selection of conversion and anti-reflective coatings, we have the capability to match demanding customer requirements.

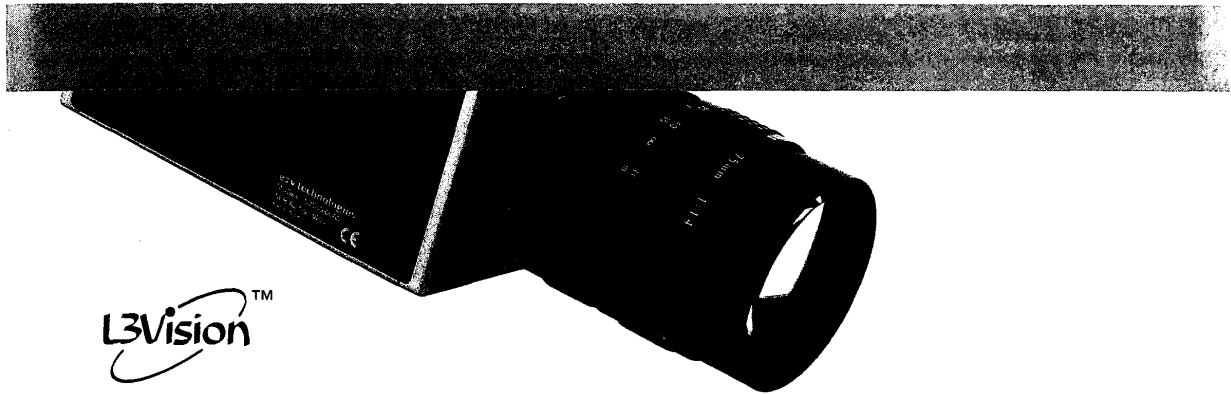

L3Vision™ is a unique, groundbreaking CCD technology from e2v technologies that offers the best low light CCD performance available today. With performance in excess of the best ICCDs, L3Vision™ finds its main areas of application in photon-starved situations, such as night-time surveillance or the detection of fluorescent and luminescent markers in lifesciences. Additionally, the sensor can detect single photons, opening the possibility of photon counting with a solid state imaging sensor. However, it is the ability to operate across the full range of light levels, with the consequent increase in system flexibility, which really makes this technology stand out.

In lifesciences, fast, high sensitivity operation can be combined with quantitative, slow scan and time integrated imaging measurements. For surveillance, true 24-hour capability is now possible in one sensor. L3Vision™ CCDs achieve their performance at very low light levels by amplifying the image signal on the chip while it is still in the charge domain. This allows the sensor to operate in real time with sub-electron equivalent read-out noise, enabling very dim sources and very dark scenes to be imaged.

L3Vision™'s low light bio- and chemi-luminescence applications

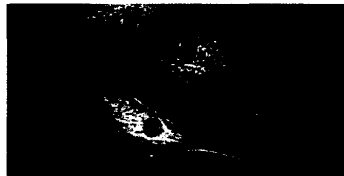

e2v's L3Vision™ sensors are capable of TV imaging at faceplate illumination levels up to 1 lux. In bright sunlight, this is achieved with an auto iris lens. At the other extreme, the sensor will image at faceplate illumination levels down to 0.1 mlux, equivalent to overcast starlight with an F1.4 lens. In overcast starlight conditions, the sensor is producing an image from only a few photons per pixel. The sensor achieves this low light performance with a simple optical path and minimizes scintillations, halo, shading and lag, creating an image that is easy on the eye and provides superb resolution and detail. The sensor exhibits excellent intrascene contrast (improved mid-band MTF) and benefits from a wide spectral response (400-1060nm). Undamaged by sudden or prolonged light overloads, L3Vision's™ ruggedness has a profound impact on system-lifecycle costs.

L3Vision™ image of scene with complex lighting taken at night

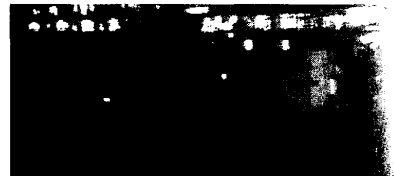

#### LOW LIGHT CAMERA SOLUTIONS

Building on the success of our low light video applications, we offer our own specialist CCD camera solutions within the L3Vision™ range. The L3C65 series camera, housing e2v's new integral Peltier sensor, offers RS170- or CCIR-compatible video imaging from bright daylight down to overcast starlight conditions. Our L3C60 camera, available with the back-thinned CCD60 at its core, utilizes a similar design approach to enable frame rate imaging up to a maximum of 500fps.

Both cameras are available as fully working modules or as unboxed sub-assemblies, which can be easily integrated into alternate camera systems. Subject to order quantity, both cameras can be specially configured to customer specification.

### SPACE & ASTRONOMY

Building partnerships coupled with exemplary technology has made us one of the leading imaging suppliers to the space industry. Headline space organizations such as NASA, ESA and ISAS have selected e2v technologies' CCDs for major research missions, including ENVISAT, the Hubble Space Telescope, XMM-Newton and Solar-B. We have also successfully participated in many missions with Universities and Research Institutes from around the world.

Mostly custom devices, these highly complex CCDs have been developed for a wide range of applications including spectroscopy, atmospheric monitoring and planetary surveys using x-ray, ultraviolet, visible light and near-infrared.

Our understanding of the effect radiation has on CCDs has led to the development of specialist techniques to reduce the impact of radiation without degrading performance. Sophisticated packaging techniques are used to optimize the thermal, mechanical, optical and practical aspects of our devices ensuring effective, reliable operation.

ENVISAT environmental monitoring satellite with an image taken of Sicily, courtesy of ESA.

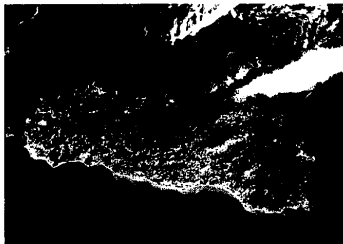

### MILITARY & SURVEILLANCE

Long established in the defense and surveillance sectors, our pre-eminent CCDs continue to offer outstanding performance in exacting applications. The parameters where we excel in the space market are those that also make serving the military market natural for us: quality, performance and security of supply. e2v technologies supplies a range of area CCDs for military video rate applications, as well as area and linear devices for high resolution surveillance purposes. Our CCDs are often used in conjunction with image intensifiers for night-time operation.

Increasingly, an L3Vision™ technology CCD is selected over an intensifier tube/CCD combination. L3Vision's™ unique capability is revolutionizing the 24-hour surveillance market. The ability to image a wide range of light levels, from overcast starlight to bright sunlight, offers a single surveillance solution that can be adapted for use on land, at sea or in the air.

S e l e c t i o n   G u i d e



e2v technologies

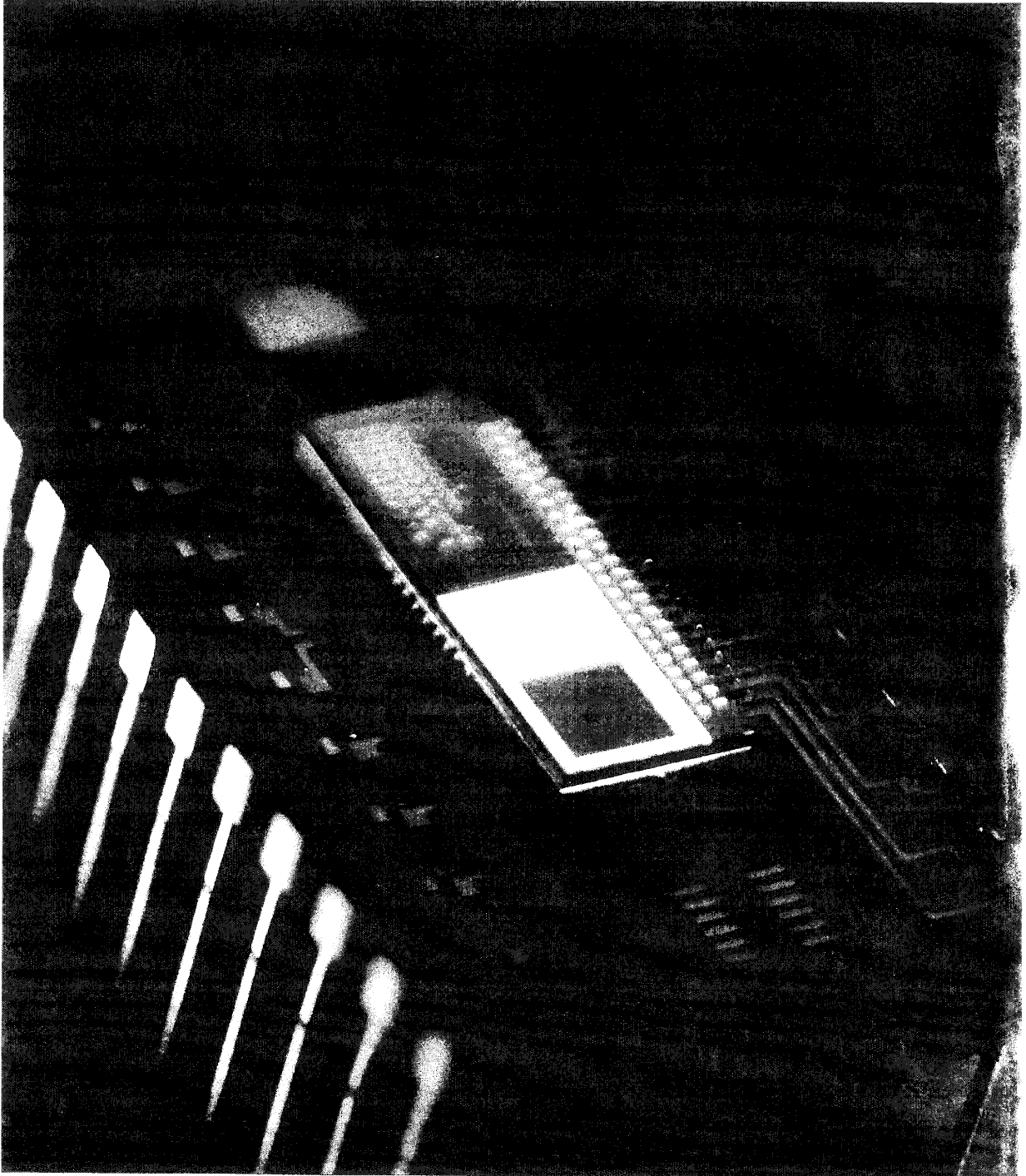



This guide describes ezv technologies' standard CCD (Charge Coupled Device) product line. ezv is known as a leader in sensitivity through the use of high quantum efficiency, back-illumination and very low read noise output amplifiers. Other options, including custom CCD designs, are also available to extend the wavelength range and sensitivity of devices across the electro-magnetic spectrum, from X-rays, through ultraviolet and visible light, to near infrared. Technical support is readily available and it is highly recommended that all new applications be discussed with ezv's sales and applications staff.

#### **PIXEL SIZE**

The selection of pixel size is a balance between basic performance parameters. Smaller pixels will give increased resolution, assuming that resolution is not limited elsewhere in the system. As the pixel size decreases, well capacity (the amount of charge that can be stored in a pixel) and the overall dynamic range decrease. As well as having a higher dynamic range, larger pixels gather more photons and hence may improve overall system sensitivity in light-starved applications. However, larger pixels also accumulate more dark current per pixel and a lower operating temperature may be necessary to offset this effect.

#### **NUMBER OF PIXELS**

This is determined by the active area and the pixel size. The number of pixels required for a given application may be limited by the readout time needed. Increasing the readout frequency will increase the read noise and may limit low signal performance. By reading out through multiple outputs, the frequency per output and hence the read noise may be reduced while maintaining the readout time.

#### **OUTPUT AMPLIFIER TYPE**

Several different types of output amplifier designs are used on ezv CCDs. The Very Low Noise (VLN) amplifier is optimized for the lowest possible read noise performance at slow scan speeds. The VLN amplifier can have a noise floor as low as 2 electrons. The Large Signal (LS) amplifier is optimized for high output node capacity to maximize dynamic range at slow scan speeds. It typically has a somewhat higher noise floor than the VLN amplifier. The High Speed (HS) amplifier is optimized for low noise at speeds of 10 MHz or higher. The dental CCDs use a moderate speed output amplifier with an integral sample and hold (S+H) to minimize the circuitry needed outside the CCD and to drive the long connection cable.

The L3Vision™ devices utilize a HS amplifier and a unique gain register that multiplies signal electrons so that they may be read at high speeds over the on-chip amplifier read noise, giving an effective noise of less than 1 electron.

#### **BACK-THINNING**

This is the process by which a front-illuminated CCD is mounted upside down on a support substrate and the bulk silicon is removed to allow the incident photons to reach the sensitive pixel wells unimpeded by intervening gate structures and insulators. Back-thinned devices have much higher quantum efficiency than standard (front-illuminated) devices. At UV and soft X-ray wavelengths, back-thinning will provide the highest quantum efficiency of any technology available today. Back-thinned devices are generally used in light-starved applications where a high signal to noise ratio is needed at very low light levels.

Back-thinned devices are available with either the basic thinning process or for better UV quantum efficiency the enhanced (or "astro") process. For most applications, the basic process is the best type to use, and combines the highest quantum efficiency with the lowest cost.

The enhanced process in combination with AIMO (Advanced Inverted Mode Operation) is only available on smaller sensors so that high row shift rates may be maintained. Larger sensors are available with the enhanced process, but only of the NIMO (Non-IMO) type.

Back-thinned devices are supplied with an anti-reflection coating, optimized for a particular wavelength, as shown in the Quantum Efficiency (QE) curves. Not all coatings are available for all types of chip, except to special order. Other coatings are available upon request.



Dental	Number of active pixels		Pixel pitch (µm)		Image size (mm)		Output amplifier type	Maximum readout rate (MHz)
	V	H	V	H	V	H		
CCD38-20	684	456	44	44	30.1	20.1	S+H	1
CCD76-40	1640	1250	22	22	36.1	27.5	S+H	1
CCD78-20	1368	912	22	22	30.1	20.1	S+H	1

Full-frame spectroscopic and scientific sensors	Number of active pixels		Pixel pitch (µm)		Image size (mm)		Output amplifier type	Maximum readout rate (MHz)
	V	H	V	H	V	H		
CCD30-11	256	1024	26	26	6.7	26.7	LS	5
CCD42-10	512	2048	13.5	13.5	6.9	27.6	2 x VLN	3
CCD42-20	1024	2048	13.5	13.5	13.8	27.6	2 x VLN	3
CCD42-40	2048	2048	13.5	13.5	27.6	27.6	2 x VLN	3
CCD42-80	4096	2048	13.5	13.5	55.2	27.6	2 x VLN	3
CCD42-90	4608	2048	13.5	13.5	62.2	27.6	2 x VLN	3
CCD44-82	4096	2048	15	15	61.4	30.7	2 x VLN	3
CCD47-10	1024	1024	13	13	13.3	13.3	2 x VLN	5
CCD55-20	1152	770	22.5	22.5	25.9	17.3	VLN + LS	7
CCD55-30	1152	1252	22.5	22.5	25.9	27.9	VLN + LS	7
CCD62-06	578	385	22	22	12.7	8.5	HS	12
CCD77-00	512	512	24	24	12.3	12.3	2 X LS	7

Frame transfer scientific sensors	Image section Number of active pixels		Store section Total pixels		Pixel pitch (µm)		Image size (mm)		Output amplifier type	Maximum readout rate (MHz)
	V	H	V	H	V	H	V	H		
CCD39-01	80	80	80	80	24	24	1.9	1.9	4 x VLN	3
CCD39-02	80	80	80	80	24	24	1.9	1.9	1 x VLN	3
CCD44-82	2048	2048	2052	2098	15	15	30.7	30.7	2 x VLN	3
CCD47-20	1024	1024	1033	1056	13	13	13.3	13.3	2 x VLN	5
CCD48-20	1024	1024	1033	1056	13	13	13.3	13.3	2 x HS	10
CCD55-20	576	770	576	804	22.5	22.5	13.0	17.3	VLN + LS	7
CCD55-30	576	1252	576	1276	22.5	22.5	13.0	27.9	VLN + LS	7
CCD57-10	512	512	528	536	13	13	6.7	6.7	2 x VLN	3
CCD62-06	288	385	290	395	22	22	6.3	8.5	LS	12
CCD67	256	256	264	268	26	26	6.7	6.7	2 x VLN	5

L3Vision™	Image section Number of active pixels		Store section Total pixels		Pixel pitch (µm)		Image size (mm)		Output amplifier type	Maximum readout rate (MHz)
	V	H	V	H	V	H	V	H		
CCD60	128	128	130	130	24	24	3.0	3.0	Low noise high capacity	18
CCD65 (525 line)	244	576	250	591	35.5	20	8.6	11.5	Low noise high capacity	16
CCD65 (625 line)	288	576	296	591	30	20	8.6	11.5	Low noise high capacity	16
CCD87	512	512	528	536	16	16	8.2	8.2	Low noise high capacity & VLN	13

**NOTE:**

Whilst ezv technologies has taken care to ensure the accuracy of the information contained herein, it accepts no responsibility for the consequences of any use thereof and also reserves the right to change the specification of goods without notice. ezv accepts no liability beyond that set out in its standard conditions of sale in respect of

infringement of third party patents arising from the use of devices in accordance with information contained herein. Not all combinations of variants are available for a single device. Users are advised to contact ezv to confirm if their particular requirements are available with a standard device before designing their system.



Readout noise (e-)	Package type	IMO	Coatings
			X-ray phosphor
150 (RNA)	Sealed plastic with cable & plug	■ (A)	■
150 (RNA)	Sealed plastic with cable & plug	■ (A)	■
150 (RNA)	Sealed plastic with cable & plug	■ (A)	■

Readout noise (e-)	Package type	Back-thinned	IMO	TE cooled peltier package	Anti-blooming	Coatings	Fiber optic	Open electrode	Hi-res deep depletion silicon
						Lumogen X-ray phosphor			
4 (RNB)	20-pin DIL ceramic	■	■ (A)			■ □	■	■	□
2 (RNB)	20-pin DIL ceramic	■	■ (A)		□	■ □	■		□
2 (RNB)	Ceramic PGA	□	□ (A)		□	□ □	□		□
2 (RNB)	24-pin DIL ceramic	■	■ (A)		□	■ □	■		□
2 (RNB)	3-side metal buttable	■	□ (A)		□				□
2 (RNB)	3-side metal buttable	■	□ (A)		□				□
2 (RNB)	3-side metal buttable	■	□						□
2 (RNB)	24-pin DIL ceramic	■	■ (A)	□	□	■ □	■		□
3 (RNB)	44-pin flat PGA	■	■ (A)		□	■ □	■		□
3 (RNB)	44-pin flat PGA	■	■ (A)		□	■ □	■		□
4 (RNB)	20-pin DIL ceramic	□	■ (A)		□	■ □	■		□
3 (RNB)	24-pin DIL ceramic	■	■	□		■ □	■		□

Readout noise (e-)	Package type	Back-thinned	IMO	TE cooled peltier package	Anti-blooming	Coatings	Fiber optic	Open electrode	Hi-res deep depletion silicon
						Lumogen X-ray phosphor			
3 (RNB)	24-pin DIL ceramic	■	■ (A)	■					
3 (RNB)	24-pin DIL ceramic	■	□ (A)	■					
2 (RNB)	3-side metal buttable	□	□						□
2 (RNB)	32-pin DIL Ceramic	■	■ (A)	■	■ (N)	■ □	■		□
35 (RNA)	32-pin DIL Ceramic	■	□	□	■ (N)	■ □	□		□
3 (RNB)	44-pin flat PGA	■	■ (A)		□	■ □	■		□
3 (RNB)	44-pin flat PGA	■	■ (A)		□	■ □	■		□
2 (RNB)	24-pin DIL ceramic	■	■ (A)	■	■ (N)	■ □	■	□	□
4 (RNB)	20-pin DIL ceramic	□	■ (A)		□	■ □	■		□
4 (RNB)	24-pin DIL ceramic	■	□ (A)	■	□	■ □	□		□

Readout noise (e-)	Package type	Back-thinned	IMO	TE cooled peltier package	Anti-blooming	Coatings	Fiber optic
						Lumogen X-ray phosphor	
< 1 (RNA)	24-pin DIL ceramic	■	■	□		■ □	□
< 1 (RNA)	36-pin PGA		■	■	■	■ □	□
< 1 (RNA)	36-pin PGA		■	■	■	■ □	□
< 1 (RNA)	30-pin DIL ceramic	■	■	□		■ □	□

- Key**
- Available
  - Subject to tooling and/or order quantity
  - (A) Advanced IMO
  - (N) Non-IMO only
  - IMO Inverted Mode Operation
  - VLN Very Low Noise scientific amplifier
  - LS Large Signal scientific amplifier
  - S+H Sample and Hold integral to output
  - HS High Speed scientific amplifier
  - DIL Dual in line
  - PGA Pin grid array
  - V Vertical
  - H Horizontal
  - TE Thermo-electric
  - RNA At maximum readout rate, FI device
  - RNB At 20kHz readout rate, FI device

# Quantum Efficiency(QE) curves - BACK-THINNED

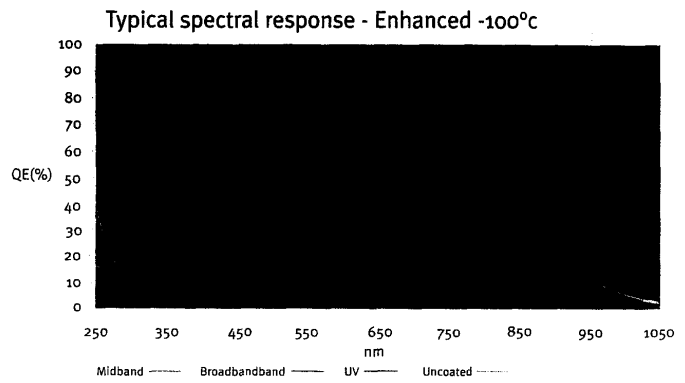
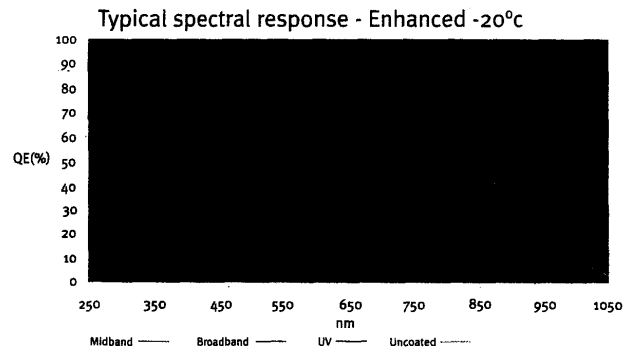
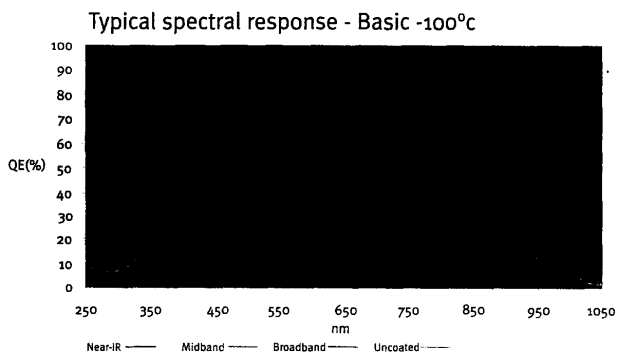
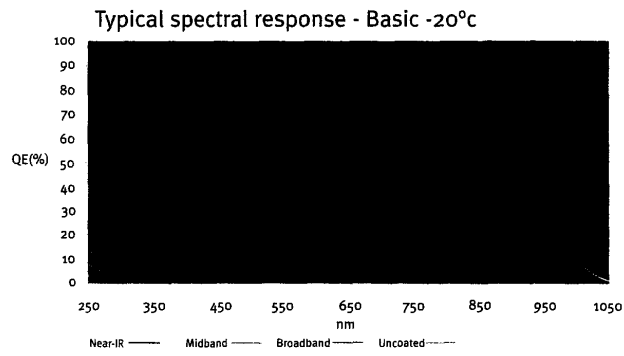

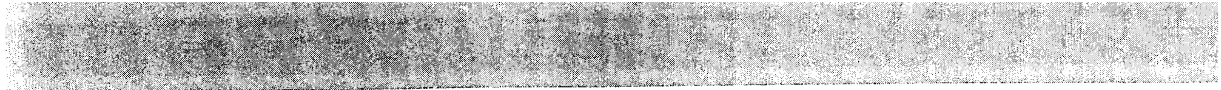

Typical spectral response - Deep depletion, basic -20°C

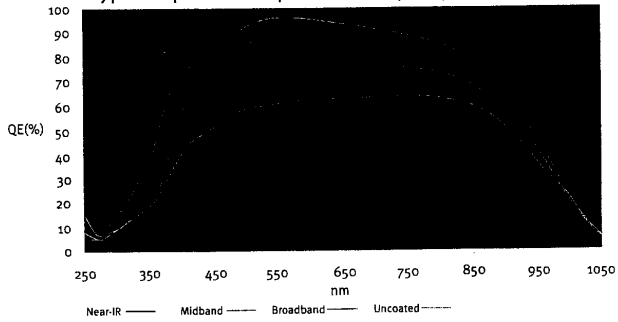

Typical spectral response - Deep depletion, basic -100°C

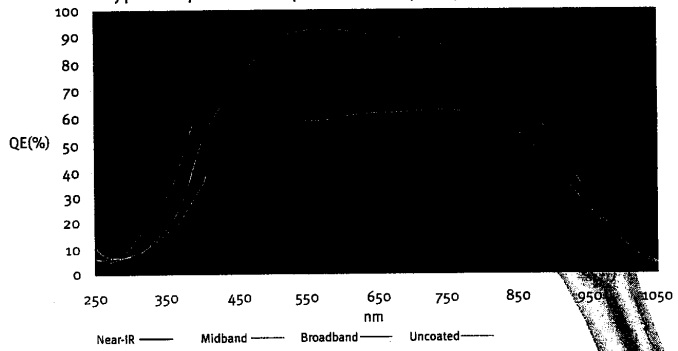

Quantum Efficiency(QE) curve - FRONT-ILLUMINATED

Typical spectral response +20°C

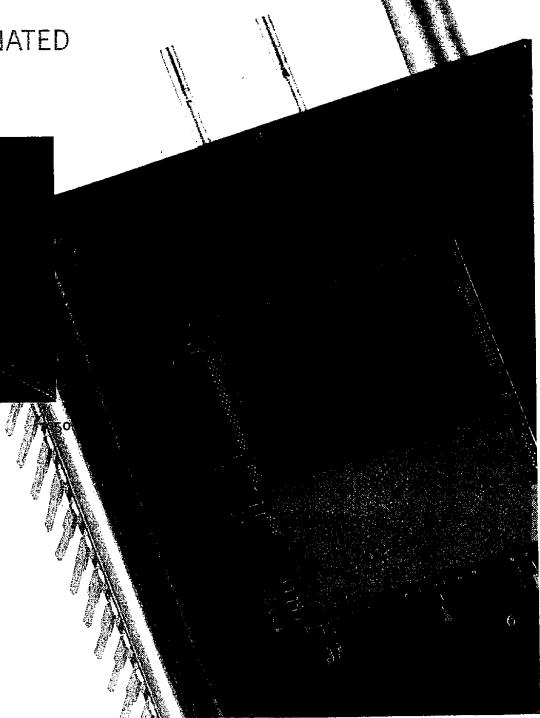
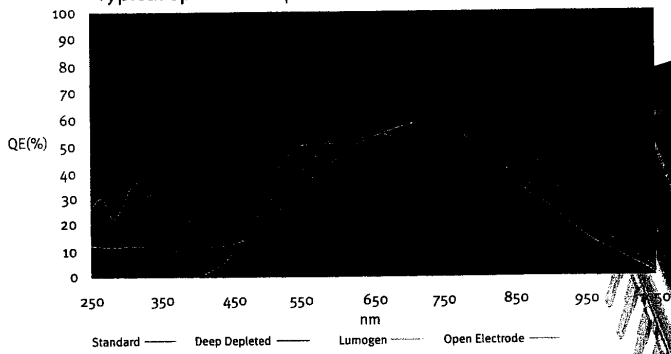

**Back Thinned CCD with Improved Etaloning Interference**

Back illuminated CCD's are thin devices which become semitransparent in the near infrared. Reflections between the nearly parallel front and back surfaces of these devices cause them to act as etalons. This etalon-like behavior leads to unwanted fringes of constructive and destructive interference which artificially modulate a spectrum. The extent of modulation can be very significant (over 20%) and the spectral spacing of fringes, typically 5 nm, is close enough to make them troublesome for almost all NIR spectroscopy.

In order to reduce the etalon effect, Hamamatsu presents the new Back-Thinned Area Image Sensors S9060 and S9061 series. These products are high sensitivity, back thinned area image sensors, ideal for high precision measurement applications in the near IR region.

With a pixel size of 24 µm x 24 µm, these CCD are available in two pixels formats 512 x 256 (suffix -0908) and 1024 x 256 (suffix -1008). The S9061 has a one-stage thermoelectric cooler. The cooler is hermetically sealed with the chip in the same package. Therefore no dry air is required, allowing easy handling. Hamamatsu have a fully comprehensive range of back-thinned CCD chips and digital CCD cameras, for all demanding applications.

Author: Alberto Verga  
Hamamatsu Photonics Italy

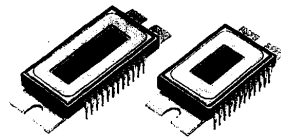

S9060, S9061

**Features:**

- Improved etaloning (interference) type
- Pixel size: 24 µm x 24 µm
- High IR sensitivity
- Line/pixel binning operation

**Applications:**

- Fluorescence spectroscopy
- Raman spectroscopy
- Semiconductor inspection
- DNA sequencer
- Low-light level detection

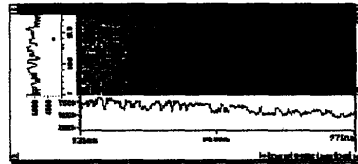
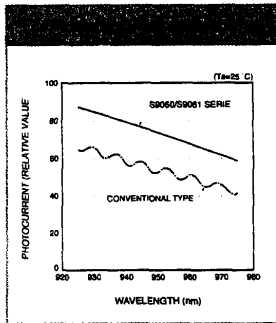

Etaloning graph for back thinned CCD

**Specifications:**

Type no	Cooling	Number of active pixel	Active area H (mm) x V (mm)	Spectral response range (nm)
S9060-0908	Non-cooled	512 x 250	12.288 x 6.000	200-1100
S9060-1008		1024 x 250	24.576 x 6.000	
S9061-0908	One-stage TE cooled	512 x 250	12.288 x 6.000	
S9061-1008		1024 x 250	24.576 x 6.000	

**CCD Multichannel Detector Head**

The C7027 is a multichannel detector head designed for front-illuminated CCD image sensors, that offers high UV sensitivity and quantum efficiency.

This new multichannel detector head incorporates a low noise driver/amplifier circuit, that provides reliable operation from a simple external signal. A highly stable temperature controller allows cooling down to a temperature level of -50°C.

The housing configuration is designed for good heat dissipation. Four mounting holes on the front panel allow connection to other devices, such as monochromators for low light level detection applications.

Hamamatsu offers two series of CCD Image Sensors suitable for use with the C7027, the S7017 and S7847 series.

Author: Federica Gornati  
Hamamatsu Photonics Italy

**Specifications:**

Type no	Cooling	Number active pixel
S7017-1007	Four stage TE cooled	1024 x 1
S7017-1008		1024 x 2
S7847-1007		1024 x 1
S7847-1008		1024 x 2

**Time Line**

● Represents Management / Capital

Production / Technology



**BT-CCD Multichannel Detector Head****Features:**

- Designed for front-illuminated CCD image sensor
- Driver / amplifier circuit for low noise CCD operation
- High stability temperature controller
- Line binning and area scanning operation

**Applications:**

- Fluorescence spectroscopy
- Raman spectroscopy
- Low-light level detection

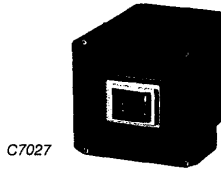

C7027

Active area (mm) x V (mm)	Spectral response range (nm)
24.576 x 2.976	400 - 1100
24.576 x 6.048	400 - 1100
24.576 x 2.976	400 - 1100
24.576 x 6.048	High IR sensitivity type

The CCD area scan camera C8677 series employs a high-speed, high resolution CCD (S8677-1010) and can be used in a wide range of applications including high-speed imaging, bio-photon imaging and semiconductor inspection. The CCD used in the C8677 series is sensitive in the ultraviolet region down to 130 nm (when CCD-faceplate is removed). The C8677 series is ideal for applications involving UV Light sources and UV Lasers. As soon as power is turned on, the C8677 series begins to operate in free running mode with a pre-set integration time and outputs continuous image data to an external unit. Image data is output in 12-bit parallel along with various timing signals for image acquisition, allowing easy connection to commercially available frame grabbers (C8677: RS-422, C8677-01: LVDS). All camera settings can be made through serial communication ports (RS-232C).

In addition to various external trigger functions, the C8677 series also provides one digital output. The C8677 series has sub-array binning to enhance the frame rate, computer-controlled gain and offset adjustments.

The CCD mounted in the C8677 series operates at high speeds and produces considerable heat so dark current increases in the CCD. To minimise dark current caused by this heat, a temperature control module is also built into C8677 series to maintain the CCD temperature near room temperatures ( $T_c = +20^\circ\text{C}$ ).

The camera body is compact yet designed to radiate heat efficiently away from the internal circuit and sensor. The CCD focal plane is flush with the front panel of the camera body making optical design easier.

Author: Arie van Gool  
Hamamatsu Photonics Deutschland

**Features:**

- Digital output
- High UV sensitivity
- High resolution
- Fast frame rate: up to 10 frames per second
- Sub-array binning: 2 x 2, 4 x 4, 8 x 8, 16 x 16
- Sensor temperature control:  $+20^\circ\text{C} \pm 0.1^\circ\text{C}$
- Easy handling (ie controllable from PC through RS-232C)

**Applications:**

- Spectrophotometry
- High-speed UV imaging
- Bio-photon observation
- Semiconductor inspection

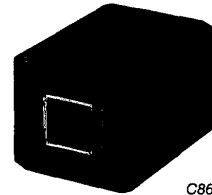

C8677

**Specifications:**

The table below shows CCD area image sensor applicable for the C8677 series. The C8677 series does not include a CCD sensor.

Type no.	Number of pixels	Number of active pixels	Active area H (mm) x V (mm)
S8677-1010	1044 x 1032	1024 x 1024	18.43 x 18.43

**1953 - 1960**

- Hamamatsu TV Co Ltd (former name) established with a capital of 500,000 Yen
- Production of phototubes began
- Trial production of photomultiplier tubes began

Image pickup tubes were put on the market  
Successful production of night vision tubes



CdS cells were put on the market  
Side-on photomultiplier tubes were put on the market

- Capital increased to 8 million Yen

**1961 - 1969**

- Tokyo office opened
- Production of PbS detectors started
- Infrared Vidicons were put on the market



**BT-CCD Multichannel Detector Head**

The CCD multichannel detector head C9265 series employs a 2/3-inch frame transfer CCD (S7987-01) for NTSG B/W and can be used in a wide range of applications including high-speed imaging, bio-photon imaging and semiconductor inspection. The CCD used in C9265 series is sensitive in the ultraviolet region (down to 130 nm after removing CCD faceplate) and is ideal for applications involving UV light sources and UV lasers.

As soon as power is turned on, the C9265 series begins to operate in free running mode with pre-set integration time and outputs continuous image data to an external unit. Image data is output in 12-bit parallel format (C9265: RS-422 or C9265-01: LVDS) along with various timing signals for image acquisition, allowing easy connection to commercially available frame grabbers.

All camera settings can be made through serial communication ports (RS-232C). In addition to various external trigger functions, C9265 series also provides one digital output. The C9265 series has a sub-array binning to enhance the frame rate, computer-controlled gain and offset adjustments.

The CCD mounted in C9265 series operates at high speeds and produces considerable heat, so dark current increases in the CCD. To minimise dark current caused by this heat, a temperature control module is also built into C9265 series to maintain the CCD temperature near room temperatures ( $T_c = +10^\circ\text{C}$ ).

**Specifications:**

The table below shows CCD area image sensor applicable for the C9265 series. The C9265 series does not include a CCD sensor.

Type no.	Number of pixels	Number of active pixels	Active area H (mm) x V (mm)
S7987-01	680 x 500	658 x 490	9.212 x 6.860

The camera body is compact yet designed to radiate heat efficiently away from the internal circuit and sensor. The CCD focal plane is flush with the front panel of the camera body making optical design easier.

Author: Arie van Gool  
Hamamatsu Photonics Deutschland

**Features:**

- High UV sensitivity: sensitive down to 130 nm
- High resolution
- Fast frame rate: up to 25 fps (frames per second)
- Sub-array binning: 1 x 1, 2 x 2
- Various trigger modes
- Sensor temperature control:  $+10^\circ\text{C} \pm 0.1^\circ\text{C}$  ( $T_a = +25^\circ\text{C}$ )
- Easy handling
- Controllable from PC (RS-232C)

**Applications:**

- High-speed UV imaging
- Semiconductor inspection
- Microscope

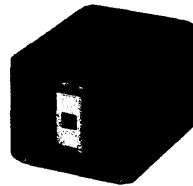

C9265

**CCD Multichannel Detector Head**

C9047 series is an industrial camera, designed for our high speed and high resolution back-thinned CCD Image Sensors S9037-0902 and S9037-1002 with 512 or 1024 pixel. It is suitable for a wide range of applications including production line inspection and surveying. The CCD Sensors are sensitive in the UV region down to 130 nm (windowless version) which makes it ideal for UV laser applications.

As soon as the power is turned on, C9047 series enters standby mode ready to output image data (12 bit digital output) in synchronization with an external trigger signal. All camera settings can be made through serial communication ports (RS-232C).

The camera body is compact yet designed to radiate heat efficiently away from the internal circuit and sensor. The CCD focal plane is flush with the front panel of the camera body making optical design easier.

Author: Andreas Hafner  
Hamamatsu Photonics Deutschland

**Features:**

- 12 bit digital output
- High UV sensitivity down to 130 nm (windowless version)
- Fast line rate  
S9037-0902: 16 kHz  
S9037-1002: 9 kHz
- Easy handling

**Applications:**

- Spectrophotometry
- High-speed UV imaging
- Bio-photon observation
- Semiconductor inspection

Silver-bismuth photomultiplier tubes put on the market  
Successful production of 1/2 inch Vidicon  
Sale of infrared video cameras began  
● Ichino factory started operation

UV-TRON and solar blind photomultiplier tubes put on the market  
Head-on type photomultiplier tubes and storage tubes put on the market

● New York office opened  
Experimental production began of hollow cathode lamps and deuterium lamps



1/2 inch side-on type photomultiplier tubes, electron multiplier tubes, pick-up storage tubes and glow modulator tubes were put on the market.



## New Photodiode Array with Amplifier

Hamamatsu have increased their range of S8865 series photodiode arrays. The S8865-256 is a photodiode array with a signal processing circuit chip. This signal processing circuit chip is formed by a C-MOS process and incorporates timing generator, shift register, charge amplifier array and clamp circuit, making the external circuit configuration simple. A long, narrow image sensor can also be configured by arranging multiple arrays in a row since the S8865 device can be stacked "end to end". For X-ray detection applications, types with fluorescent phosphor affixed to the active area are also available.

Author: Oliver Roesler  
Hamamatsu Photonics Deutschland

### Features:

- S8865-256: 0.2 mm pitch; 256 ch; 51.2 mm
- 5 V single power supply operation
- Sequential readout with a shift register (Data rate: 1 MHz max.)
- Integrated clamp circuit allows low noise and wide dynamic range
- Integrated timing generator allows operation at two different pulse timings

### Applications:

- Long line sensors
- Line sensors for X-ray detection

## New Compact C-MOS Driver Circuit

The C9118 series C-MOS driver circuit is designed for the S8865 series photodiode array with amplifier.

The C9118 series operates a linear image sensor by just inputting two signals (M-CLK and M-RESET) and a single +5 V supply voltage. It is assembled on a compact board, allowing downsizing of the measuring equipment. This driver circuit is intended for single use or parallel connections, while the C9118-01 is suitable for cascade connections.

Author: Oliver Roesler  
Hamamatsu Photonics Deutschland

### Features:

- Single power supply
- Operation with two input signals
- Compact size, 48 mm x 56 mm

### Applications:

- Image acquisition
- Optical detection equipment

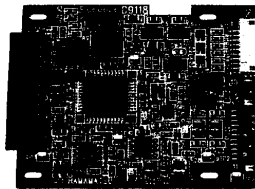

C9118

## Si Photodiodes with Precision Human Eye Spectral Response

For precision measuring instruments demanding a very accurate human eye spectral response the S9219 series is the optimal choice. These photodiodes have an integrated visible compensation filter which closely matches human eye response.

The S9219 series is ideal for demanding photometry and luxmeter applications. The S9219 series filter has been improved. There are two different active areas and types of package available as standard.

Author: Dieter Habben  
Hamamatsu Photonics Deutschland

### Specifications:

Type no.	S9219	S9219-01
Spectral response range (nm)	380 ... 780	380 ... 780
Peak sensitivity wavelength (nm)	555	555
Sensitivity at peak sensitivity wavelength (A/W)	0.24	0.22
Active area (mm)	dia. 11.3	3.6 x 3.6
Package	BNC	TO-5

For less demanding applications, Hamamatsu also offers a broad range of human eye response photodiodes.

S5493-01, S5627-01	filterless, low cost
CdS cells	low cost, resistor
S7565	linear, Photo-IC, low cost
S7686	fast speed, sensitivity close to the human eye
S7123-01, S7123-02	wider operating temperature range, filterless
S9066, S9067	Photo-IC, without filter
S9219	high precision

The S8865 series photodiode array with amplifier was put on the market in 1970. Hamamatsu Photonics Deutschland

Image dissectors, Irisorders and multi-alkali photomultiplier tubes put on the market

### 1970 - 1979

Side-on type multi-alkali photomultiplier tubes, hollow cathode lamps and deuterium lamps were put on the market. 3" photomultiplier tubes launched for the scintillation counting market

1/2 inch head-on photomultiplier tubes, photon-counting photomultiplier tubes, GaAs photomultiplier tubes, Si photodiodes and X-ray Vidicons were put on the market

**HAMAMATSU**

### Low Cost C-MOS Linear Image Sensors

The S9226/S9227 are a new kind of small, easy to use low cost linear image sensors from Hamamatsu. These, low cost devices, are ideal for applications such as position detection and low cost spectroscopy.

In our Euronews 2-2002 we presented our new integrated C-MOS linear image sensors. They allow easy operation, by just inputting 2 signals and a single +5 V supply voltage.

The S9226/S9227 are new (small) members of this family offering the same simple operation.

When high linearity is needed the smaller pixel type S9226 is the choice. It has a built-in signal processing circuit. It can be used for the low current 3.3 V technology. The S9227 allows high speed up to 5 MHz video data rate. Simultaneous integration and built in shutter allows the correct data transfer even when the light input changes.

Author: Dieter Habben  
Hamamatsu Photonics Deutschland

#### Applications:

- Position detection
- Image reading
- Analytical equipment

#### Applications:

- Position detection
- Image reading

#### Specifications:

Type no.	S9226	S9227
Pixel pitch (µm)	7.8	12.5
Pixel height	125	250
Number of pixels	1024	512
Video data rate (kHz)	max. 200	max. 5000
Supply voltage (V)	3.3, 5	5
Spectral response range (nm)	400 - 1000	
Housing	8-pin DIP, 16-pin SMD available	
Timing	Built in timing generator - only start and clock pulse necessary	
Specialities	On-chip charge amplifier	Shutter function

### InGaAs Linear Image Sensors

Hamamatsu has released an improved range of InGaAs linear image sensors.

Compared to the previous types, our G80xx or G81xx series, the Si C-MOS multiplexer chip has been changed. The key point of this new development is to improve the characteristics whilst making it compatible to the previous types.

The input and output (analog and digital) signals, the basic circuit connection, the dimensional outline, the pin connection and the cooling efficiency are the same, compared to former types.

The dynamic range has however been increased from 15000 to 18700 (G9204-512S) and the dark current decreased by a factor of 6 (G9204-512S). The linearity error at a level of 50% of Vsat decreased by 3 times. These improvements enable the user to operate our 2.6 µm cutoff wavelength array up to 100 ms integration time.

Slight changes in existing circuits are only in timing chart (10 extra clocks) and the reference voltage, which has to be adjusted to 1.26 V.

Customers can choose between 2 different packages, ceramic DIL and metal package. The metal package is hermetically sealed and

can be used with internal Peltier cooling. The ceramic package is a lower cost, but it can only be operated without internal cooling.

Hamamatsu offers readout circuits for all different types of detectors.

Author: Andreas Hafner  
Hamamatsu Photonics Deutschland

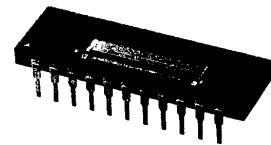
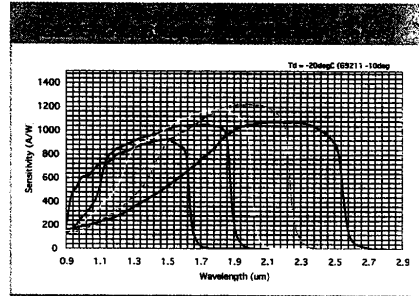

#### Specifications:

λc	Pixel pitch, number of pixel	Pixel height (µm)	Cooling	Dead pixel (max.)	Package	Type number	
1.70 µm	50 / 256	250	No	0%	Metal	G9201-256R	
1.67 µm			1TEC			G9201-256S	
1.70 µm	25 / 512	250	No		Ceramic DIL	G9202-512R	
1.67 µm			1TEC			G9202-512S	
1.70 µm	50 / 256	500	No		Metal	G9203-256D	
1.70 µm			1TEC			G9203-256R	
1.70 µm	25 / 512	500	No		Ceramic DIL	G9204-512D	
1.67 µm			1TEC			G9204-512R	
1.67 µm	50 / 256	250	1TEC		Metal	G9211-256S	
1.67 µm						500	G9212-512S
1.85 µm	50 / 256	250	2 TEC		5%	Metal	G9213-256S
2.05 µm							G9214-512S
2.25 µm				G9205-256W			
2.55 µm				G9206-256W			

- A joint company, Hamamatsu Television Europe GmbH, was established in Germany
- Capital increased to 90 million yen

Photomultiplier tubes for X-ray CT scanners and Imagers were put on the market



Computer compatible video cameras and streak camera systems put on the market



Micro channel plates, GaAsP and Si PIN photodiodes were put on the market

- Osaka sales office opened

PSDs and high temperature photomultiplier tubes were put on the market



**Profile Sensor**

The S9132 profile sensor has many advantages when compared to conventional C-MOS area image sensors and 2D position sensitive detectors (PSDs), including for example, improved output linearity and the ability to detect multiple light spots. The sensor is designed for use in inspection equipment and medical measurement devices. The S9132 acquires a projection profile in the X and Y axis to produce high-speed position and moving object detection. It has a 1.9968 by 1.9968 mm<sup>2</sup> active area with a 256- by 256-pixel array. Spectral response range is 350 to 1150 nm. At 780 nm, peak sensitivity of 40 V/nJ (high gain) or 8 V/nJ (low gain) is achieved. This high performance C-MOS sensor, integrated on the same chip with a timing and bias voltage generator and a 10-bit AD converter circuit, allows operation with very simple external signal processing circuits.

Author: Alberto Verga  
Hamamatsu Photonics Italy

**Features:**

- 10 bit / 8 bit switchable AD converter
- High speed frame rate
- Multiple light spots detection

**Applications:**

- Light spot position detection
- 3D measurement
- Moving object detection

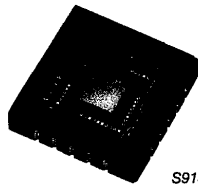

S9132

**Specifications:**

Type no.	Number of pixels	Pixel pitch (μm)	Active area (mm <sup>2</sup> )	Spectral response (nm)	Resolution
S9132	256 x 256	7,8	1.9968 x 1.9968	350 - 1150	10 or 8 bit

**830 nm 1W CW Laser Diode**

Hamamatsu offers a variety of laser diodes emitting at 808 nm. However, some applications need very specific wavelength emission. To meet these specific needs, Hamamatsu has the skill to adapt the LD emission to your required wavelength range. This can be either a customised product or one from our existing large range of standard laser diode products. We have newly released the 830 nm 1 W CW laser diode L9277-42. Other LD with wavelength at 850 nm, 920 nm and 980 nm will be released soon.

The output power of L9277 is far over 1 W having an emission area of 1 μm x 50 μm for excellent focussing characteristics. It comes in a sealed 9.0 mm CD package ideal for single laser applications. OHS package with side-out (-62) or head-out (-72) laser diode emission directions are also available. The OHS package is taking account of the heat dissipation by a special heat sink used as needed e.g. for compact or multiple laser integration. For most applications such as printing or measuring instruments, the peak emission variation within ±10 nm is not relevant and decreases cost. A smaller value of variation can be selected if required. The L9277 series is an excellent small-band NIR emitter used in many applications such as printing, optical measuring instruments, medical instruments and pumping source for solid state lasers. They are known for their excellent differential energy efficiency. The high stability and long life of this compact laser diode will provide reliable operation for your optical instruments and measurements.

Author: Marius Metzger  
Hamamatsu Photonics France

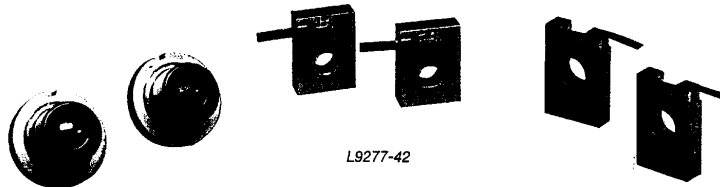

L9277-42

**1980 - 1984**

Hamamatsu Corporation began production of photomultiplier tubes



Image Intensifiers and Night Viewers were put on the market

- Tenno Glass Works completed



Digital radiography video cameras, 20 inch photomultiplier tubes and 2D photon counting imager tubes were put on the market

- Company name changed to Hamamatsu Photonics K.K
- Capital increased to 495 million Yen





# Light Platform

HASO's optomechanical add-on

## PRINCIPLE

- Increase in HASO wavefront sensor's functionalities by adding a light source and an optical system.
- Now able to measure wavefront generated by the system to characterise and then its shape imperfections. HASO still keeps its classical functions: MTF and PSF processing.

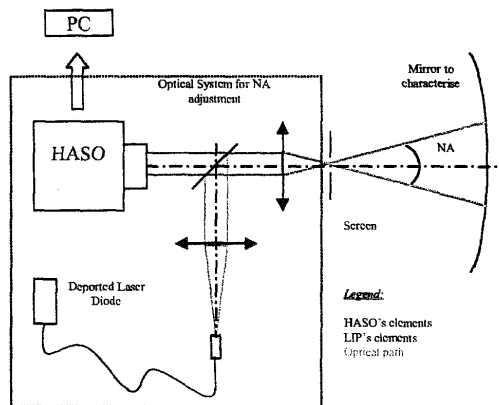

A deported laser diode (630 nm), a beam splitter and lenses, with the HASO, allow to measure and process data on convergent systems which numerical aperture is between 4 and 30, that allows the direct measurement of concave mirrors (N= 2 to N= 15).

**Legend:**  
 HASO's elements  
 LIP's elements  
 Optical path

## ADVANTAGES

### Light Platform advantages:

- Cost reduction for setting up
- Time gain (setting up and measurement)
- Adaptable on HASO II 32 and 64
- Direct characterisation of opened mirrors, till N=2.

### HASO advantages:

- Insensibility to vibrations and atmospheric perturbations.
- Real time display and processing (average possible for stabilised measures.)
- Use HASO with or without Light Platform :
  - Simple and repeatable fixation on HASO II sensor.
  - Compatible with classical HASO's functionalities.
  - Only one software to run both HASO and Light Platform.

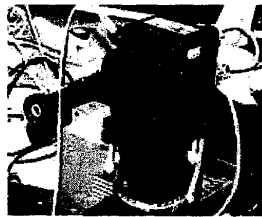

## APPLICATIONS

Concave

Convergent

Aspherical

### Main application:

- Direct characterisation of convergent optical systems.
- Real time controls and adjustments.
- WFE (Wave Front Error) and concave mirrors defaults characterisation

### And also:

- Specific engineering  
Custom developments for dedicated applications (mirror N=1 ...).
- MTF Measurement  
MTF processing and displaying.

# Light Platform

## TECHNICAL DATA:

Modules Available in standard version  
(numerical apertures):  
6.2 / 10 / 16 / 24



Modules available on request (numerical apertures):  
4 / 30

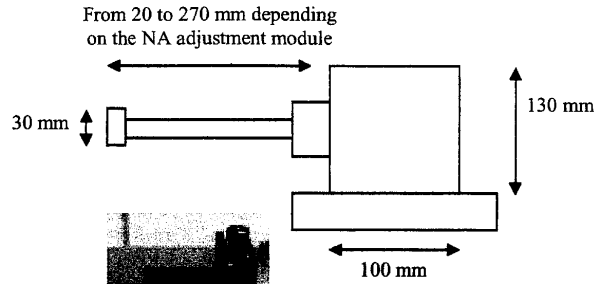

With the 5 axis stage (optional), the optical axis' height is adjustable between 168 and 242 mm.

## SPECIFICATIONS (HASO II PLUS LIGHT PLATFORM)

	HASO 32	HASO 64
Analysing aperture dimension	5 x 5 mm <sup>2</sup>	12 x 12 mm <sup>2</sup>
Number of sub-apertures	32 x 32	64 x 64
Wavefront measurement accuracy (rms)	~ λ/100 <sup>(1)</sup>	
Pupil Conjugation <sup>(2)</sup>	1 m	
Source wavelength	630 nm	
Working Temperature	15 - 30 °C	
Power supply	5,-12,12 V / 6 W	+5,-5,-15,28 V / 20 W

- (1) Depending on reference optic quality  
(2) System design for a 1 meter pupil conjugation.

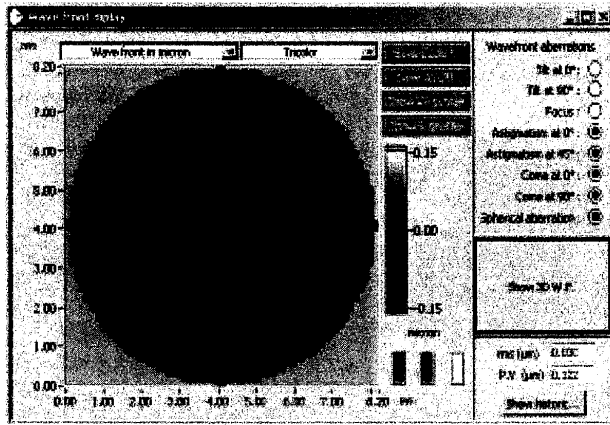

## SET UP :

The minimal configuration for convergent systems characterisation require the following elements:

- 1 Light Platform
- 1 HASO II
- 1 five axis stage (Optional)
- 1 refrence mirror (Optional)

Development of specific configurations on request.

## REFERENCES:

HASO and Light platform are already in use at:

ALCATEL SPACE INDUSTRIE, CYBERNETIX, NASA, NATIONAL OBSERVATORY OF CHINA ...

Imagine Optic - 18, rue Charles de Gaulle - 91400 Orsay - France  
tel: + 33 1 64 86 15 60 - fax: + 33 1 64 86 15 61 - e-mail: contact@imagine-optic.com



## HASO II

*new generation wavefront sensor*

### PRINCIPLE

*More Performant*

### APPLICATIONS

*Beam Analysis*

*Phase and Intensity*

*MTF*

*Characterization*

*Adaptive Optics*

### ADVANTAGES

*Real Time*

*High Dynamic*

*Interactivity*

➤ **Optical wavefront sensor**

These wavefront sensors (Shack-Hartmann type) allow to obtain a map of local slopes of the analysed wavefront with the help of a microlenses array. This principle used for a long time in astronomy was amply improved as well on hardware as on software. The CCD detectors reached the maturity and the necessary quality/price ratio to certify an irreproachable metrology with moderate prices; the fabrication of microlenses arrays has become reliable. The software innovations of Imagine Optic allow to use trough optimal way this simple and direct measurement.



➤ **Beams analysis in phase and intensity**

Laser, laser diode and all the coherent or incoherent light sources: the HASO allows to measure divergence, position and size of the waist,  $M^2$  parameter, Strehl ratio, astigmatism values, ...

➤ **Components and systems characterization**

Especially adjusted to middle size components (aperture of 5 to 12 mm), the HASO dynamic allows the analysis of small and large components too with divergent or convergent beam.

➤ **Focal length, MTF and point spread function measurement**

➤ **Adjustment, mounting, alignment**

The operator visualizes in real time the wavefront and some measured parameters, which show adjustments quality and allow to improve them (tilts and curvature values, space source position, third order aberrations which can move during an adjustment).

➤ **Active and adaptive optics**

Wavefront correction in real time with  $\lambda/10$ - $\lambda/20$  pv.

➤ **Achromatic and non sensitive to the coherence**

Particularly, monochromatic wavefront analysis.

➤ **Display and calculation in real time**

Adjustment and on-line control.

➤ **High spatial resolution**

Up to 4096 points measured in a standard configuration on the pupil.

➤ **Strong divergent and convergent beams analysis**

➤ **Wavefronts measurement in absolute or relative mode**

The HASO is factory calibrated. The measure is absolute except if a reference wavefront is specified.



# HASO II

## SPECIFICATIONS

	HASO 16	HASO 32	HASO 64
Aperture dimension	2,5 x 2,5 mm <sup>2</sup>	5 x 5 mm <sup>2</sup>	12 x 12 mm <sup>2</sup>
Number of sub-apertures dedicated for analysis (1)	16 x 16	32 x 32	64 x 64
Tilt dynamic range	> ± 3 ° (260 λ)	> ± 3 ° (520 λ)	> ± 3 ° (1200 λ)
Focus dynamic range	± 0,025 m to ± ∞ (50 λ)	± 0,025 m to ± ∞ (200 λ)	± 0,04 m to ± ∞ (800 λ)
Repeatability (rms)	< λ/200		
Wavefront measurement accuracy in absolute mode rms (2)	λ/100		
Wavefront measurement accuracy in relative mode rms (3)	λ/150		
Tilt measurement sensitivity	6 μrad	3 μrad	1 μrad
Focus measurement sensitivity	5.10 <sup>-3</sup> m <sup>-1</sup>	10 <sup>-3</sup> m <sup>-1</sup>	5.10 <sup>-4</sup> m <sup>-1</sup>
Spatial resolution	~160 μm	~160 μm	~190 μm
Max acquisition frequency	955 Hz	77 Hz	20 Hz (opt. 40 Hz)
Processing frequency	8-40 Hz	4-20 Hz	2-10 Hz
Working wavelength	350-1100 nm		
Calibrated wavelength band	400 - 600 nm / 500 - 700 nm / 650 - 900 nm / 800 - 1100 nm		
Extended calibrated wavelength band	400 - 700 nm / 500 - 900 nm / 650 - 1100 nm		
Working temperature	15 - 30 °C		
Dimensions / weight	90x100x130 mm / 1125 g	80x90x100 mm / 980 g	90x100x130 mm / 1200 g
Power supply	5,-12,12 V / 6 W	5,-12,12 V / 6 W	+5,-5,-15,28 V / 20 W

these data are given for the central wavelength of the band defined

(1) other configurations are available: HASO 50 for instance.

(2) wavefront seen by the analyser. performance kept on the whole band

(3) difference between the real wavefront and a reference wavefront obtained in similar conditions (10 λ of shift max).

## SOFTWARE

### Wavefront acquisition

Continuous or ext. trigger mode – absolute (factory calibration) or referenced (user calibration) mode – one-shot or flying acquisition – camera signal – background signal : save and subtract in real time – for the sensor adjustment : tilt visualization ; manual adjustment of integration time.



### Wavefront reconstruction

Wavefront display (unit in microns or lambda) : 3D, 2D projection, fines mode, xy profile, save function (text or excel format, comments) – display in real time without tilt and/or focus and/or 3<sup>rd</sup> order aberrations – intensity display : 3D, 2D projection, xy profile, save function (text or excel format, comments) – reconstruction : zonal or modal (Zernike or Legendre) – pupil shape : with or without central occultation – location (x y z) of the focus point – polynomial coefficient display (unit in microns or lambda), historic function : display of the time changes of 4 coef. – local slopes display : with or without tilt and focus, zoom, rms and pv of the slopes - pupil calculation : automatic or manual (save and load functions) – spot diagram in real time for various observation positions.

### Extended wavefront reconstruction

Zernike polynom coefficient processing in real time for any pupil shape – display of the calculated wavefront surface and display of the residual – manual or automatic choice of the pupil - save functions: text or excel format, comments

### Point Spread Function measurement

PSF display : 3D, 2D projection, xy profile – parameters : best focus plane, user specified plane, focal plane of ideal lens – zoom (1 to 8) – Strehl ratio – numerical value in table - save and load functions (text or excel format, comments).

### MTF measurement

MTF display : 2D, x profile (user choice) – parameters : best focus plane, user specified plane, focal plane of ideal lens – zoom (1 to 8) – historic function : display of the time change of a specified frequency - save and load functions (text or excel format, comments).

### Laser characterisation

Beam location, dimension and position of the waist – display of the beam shape – M<sup>2</sup> calculation – calculation of intensity shape in any plane - save and load functions (text or excel format, comments).

### Dynamic library

dll in C or VI for Labview : all the software functions to build specific soft applications.

Imagine Optic - 18, rue Charles de Gaulle - 91400 Orsay - France  
Tel : +33 1 64 86 15 60 - fax: +33 1 64 86 15 61 - e-mail: contact@imagine-optic.com



Imagine Optic

Preliminary

# HASO HR

L'analyseur de front d'onde très haute dynamique

Nouveau

## PRINCIPE

Plus Performant

### > Analyseur de surface d'onde optique

Ces analyseurs de front d'onde de type Shack-Hartmann bénéficient d'une nouvelle génération de matrice de microlentilles (le concept « carré tourné »), brevetée par Imagine Optic. Cette innovation permet d'améliorer les performances du HASO II du point de vue résolution spatiale et dynamique de mesure.

S'ajoutant aux innovations logicielles d'Imagine Optic, la technologie « carré tourné » permet d'augmenter la résolution, la dynamique et la plage de mesure en longueur d'onde des analyseurs Shack Hartmann.

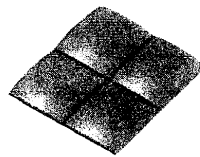

Concept classique  
HASO II

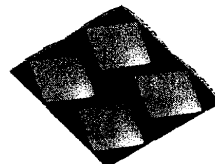

Concept « carré tourné »  
HASO HR

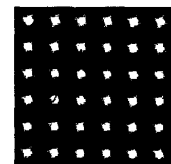

Hartmanngramme  
à partir de « carré tourné »

## APPLICATIONS

Analyse de Faisceaux  
Phase et Intensité

FTM

Caractérisation

Optique Adaptative

Cet instrument étend les possibilités de mesure du HASO

### > Analyse de faisceaux en phase et intensité

Le HASO HR facilite la mesure sur laser et plus généralement sur faisceau monochromatique

### > Caractérisation de composants et de systèmes

Particulièrement adapté à la caractérisation de composants de taille moyenne (ouverture de 5 à 12 mm), la dynamique du HASO HR lui autorise également, comme pour le HASO II, l'analyse de « petits » ou de « grands » composants en faisceau convergent ou divergent. Le HASO HR est compatible avec l'accessoire LIP ainsi qu'avec la platine de rotation du HASO.

### > Mesure de focale, de f<sub>tm</sub> et de réponse percussionnelle

### > Réglage, montage, alignement

Les opérations d'ajustement restent, à l'aide du HASO HR, très simples ce qui fait de cet instrument un outil parfaitement adapté tant aux besoins de laboratoires qu'au contrôle de process industriel

### > Optique active et adaptative

Correction de surface d'onde en temps réel à  $\lambda/10$ - $\lambda/20$  pv

## AVANTAGES

Meilleure Résolution

Dynamique Améliorée

Plage en  $\lambda$  étendue

Ce capteur conserve les avantages du HASO II mais constitue une amélioration globale de la technologie, avec notamment :

### > Haute résolution spatiale

Jusqu'à 6400 points de mesure en standard sur la pupille pour un HASO HR 80. Le HASO HR 90 est démontré et le HASO 160 est en preliminary...

### > Une plage en $\lambda$ étendue

Il est désormais possible de mesurer sur plage encore plus étendue qu'auparavant ! par exemple, vous pouvez avec le même analyseur caractériser un faisceau à 532 nm et un autre à 1064 nm...

### > La meilleure dynamique du marché !

un gain de 50 % par rapport au HASO II

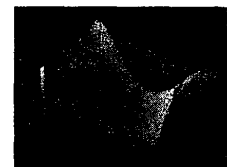

<http://www.imagine-optic.com>



## SPECIFICATIONS

	HR 44	HR 80
dimension de la pupille d'analyse	5 x 5 mm <sup>2</sup>	12 x 12 mm <sup>2</sup>
nombre de sous-pupilles pour l'analyse (1)	4x4	80 x 80
dynamique de mesure du tilt	> ± 3 ° (520 λ)	> ± 3 ° (1200 λ)
dynamique de mesure de la courbure	± 0,020 m à ± ∞ (300 λ)	± 0,025 m à ± ∞ (1200 λ)
dynamique de mesure (spécifiée en courbure locale)	± 0,020 m	± 0,025 m
répétabilité (rms)	< λ/200	
exactitude de mesure en mode absolu du FO rms (2)	~ λ/100	
exactitude de mesure en mode relatif du FO rms (3)	~ λ/150	
sensibilité de mesure du tilt rms	3 μrad	1 μrad
sensibilité de mesure de la courbure rms	10 <sup>-3</sup> m <sup>-1</sup>	5.10 <sup>-4</sup> m <sup>-1</sup>
résolution spatiale	~ 115 μm	~ 150 μm
fréquence d'acquisition max	77 Hz	20 Hz
fréquence de traitement (selon config)	4-20 Hz	2-10 Hz
longueur d'onde de fonctionnement	350-1100 nm	
plage de longueur d'onde calibrée	400 - 700 nm / 500 - 900 nm / 650 - 1100 nm	
plage étendue de longueur d'onde calibrée	400 - 800 nm / 532 - 1100 nm	
température de fonctionnement	15 - 30 °C	
dimensions / poids	80x90x100 mm / 980 g	90x100x130 mm / 1200 g
alimentation voltage / puissance	5,-12,12 V / 6 W	+5,-5,-15,28 V / 20 W

les données de ce tableau correspondent à la longueur d'onde centrale de la plage définie.

(1) un nombre différent de sous-pupilles peut être proposé sur demande: par exemple HASO HR 90 ou HASO HR 160 (preliminary)

(2) front d'onde tel qu'il est vu par l'analyseur, performance sur la plage de longueur d'onde calibrée.

(3) différence entre le front d'onde réel et un front d'onde de référence pour une dynamique inférieure à 10 λ.

## LOGICIELS

### Acquisition du front d'onde

Synchrone ou asynchrone – absolu (référence usine) ou relatif (référence utilisateur) – moyennage – acquisition à la volée et traitement différé – visualisation du signal caméra – signal de fond : enregistrement et soustraction temps réel – assistant réglage du capteur : visualisation du tilt - réglage manuel du temps d'intégration



### Reconstruction de front d'onde

Visualisation de la surface d'onde (en micron ou lambda) : 2D fausses couleurs, 3D, mode franges, profil, enregistrement : format standard ou texte, commentaires – suppression à l'affichage en temps réel des aberrations de tilt, focus et 3<sup>ème</sup> ordre – visualisation du front d'intensité : 2D fausses couleurs, 3D, profil, enregistrement : format standard ou texte, commentaires – reconstruction zonale, modale Zernike ou modale Legendre – pupille de forme quelconque avec ou non occultation centrale - localisation x, y, z du point de focalisation du faisceau – visualisation des coefficients des polynômes (en micron pv ou lambda); historique : visualisation de l'évolution temporelle de 4 coefficients de polynômes – visualisation des pentes locales : suppression possible de l'influence des tilts et du focus, zoom, rms et pv des pentes – calcul de la pupille automatique ou choix manuel (enregistrement de configurations possibles) – spot diagram temps réel dans différents plans d'observation.

### Reconstruction expert

Calcul des coefficients des polynômes de Zernike sur une surface d'onde zonale de forme quelconque – visualisation de la surface calculée et de la surface résiduelle – ajustement manuel ou automatique de la zone de calcul – enregistrement : format standard ou texte, commentaires

### Mesure de réponse percussionnelle

Visualisation de la réponse percussionnelle : 2D fausses couleurs, 3D – paramètres : plan de meilleure focalisation, plan défocalisé (spécifié par l'utilisateur), au foyer d'une lentille parfaite (spécifiée par l'utilisateur) – profil, seuillage, zoom (x1 ; x8) – rapport de Strehl – visualisation des valeurs numériques – enregistrement : format standard ou texte, commentaires

### Mesure de FTM

Visualisation de la FTM : profil (spécifié graphiquement par l'utilisateur), 2D – paramètres : identiques à réponse percussionnelle – historique : choix d'une fréquence – enregistrement : format standard ou texte, commentaires

### Caractérisation de laser

Localisation du faisceau, taille et position du waist – visualisation de la forme du faisceau – calcul du M<sup>2</sup> – calcul de la répartition d'énergie dans un plan quelconque – enregistrement : format standard ou texte, commentaires

### Librairie de fonctions

dll en C ou VI pour LabView : comprennent l'ensemble des fonctions nécessaires au développement de logiciels spécifiques

Imagine Optic - 18, rue Charles de Gaulle - 91400 Orsay - France  
tel: + 33 1 64 86 15 60 - fax: + 33 1 64 86 15 61 - e-mail: [contact@imagine-optic.com](mailto:contact@imagine-optic.com)



## HASO NIR

*new wavefront sensor for telecom applications*

### PRINCIPLE

*More Performant*

*Low Cost Solution!*

### APPLICATIONS

*Beam Analysis*

*Phase and Intensity*

*MTF*

*Characterization*

*Fiber Coupling*

### ADVANTAGES

*Real Time*

*High Dynamic*

*Interactivity*

#### > **Optical wavefront sensor**

These wavefront sensors (Shack-Hartmann type) allow to obtain a map of local slopes of the analysed wavefront with the help of a microlenses array. This principle used for a long time in astronomy was amply improved as well on hardware as on software. But the CCD technology does not allow measurement in the telecom range, and especially around 1,5  $\mu\text{m}$ . The InGaAs photodiodes technology is extremely expensive and does not answer to quality criteria to guaranty a good Shack-Hartmann metrology (reliability, dead pixels, etc...). Some detectors (based on a phosphor coating technology on a CCD) reached the maturity and the necessary quality/price ratio to certify an irreproachable metrology with moderate prices; the fabrication of microlenses arrays has become reliable. The software innovations of Imagine Optic allow to use trough optimal way this simple and direct measurement.

#### > **Beams analysis in phase and intensity**

1500 nm laser source: the HASO allows to measure optical quality, divergence, position and size of the waist,  $M^2$  parameter, Strehl ratio, astigmatism values, ...

#### > **Components and systems characterization**

Especially adjusted to middle size components (aperture of 5 mm), the HASO dynamic allows also the characterization of small and large components with divergent or convergent beam.

#### > **Adjustment, mounting, alignment**

The operator visualizes in real time the wavefront and some measured parameters, which show adjustments quality and allow to improve them (tilts and curvature values, space source position, third order aberrations which can move during an adjustment). When the user ends operation, he can get the optical quality (and especially the MTF).

#### > **Point spread function**

The phase and intensity measurement lead to the PSF (shape and location of the focus spot). Then it is possible to know accurately the fiber coupling efficiency and to understand some bad performances.

#### > **Achromatic and non sensitive to the coherence**

Particularly, monochromatic wavefront analysis.

#### > **Display and calculation in real time**

Adjustment and on-line control..

#### > **High spatial resolution**

Up to 1200 points measured in a standard configuration on the pupil.

#### > **Strong divergent and convergent beams analysis**

Compatible with fiber and laser source.

#### > **Wavefronts measurement in absolute or relative mode**

The HASO is factory calibrated. The measure is absolute except if a reference wavefront is specified.

## SPECIFICATIONS

	HASO NIR 32	HASO NIR 40
aperture dimension	4,8 x 6,4 mm <sup>2</sup>	4,8 x 6,4 mm <sup>2</sup>
number of sub-apertures dedicated for analysis	25 x 32	30 x 40
dynamic meas. range by sub pupil without tilt and focus	~ ± 2 λ	~ ± 2 λ
tilt dynamic range	till ± 3°	till ± 5°
focus dynamic range (1)	± 0,025 m to ± ∞	± 0,016 m to ± ∞
maximum operating aperture (half angle sinc)	0,11 (max)	0,17 (max)
repeatability (rms)	~ λ/80	~ λ/70
wavefront measurement accuracy in absolute mode rms (2)	~ λ/40	~ λ/35
wavefront measurement accuracy in relative mode rms (3)	~ λ/60	~ λ/50
tilt measurement accuracy	8 μrad	12 μrad
focus measurement accuracy	10.10 <sup>-3</sup> m <sup>-1</sup>	15.10 <sup>-3</sup> m <sup>-1</sup>
spatial resolution	~190 μm	~ 160 μm
acquisition frequency / processing frequency	~20 Hz / ~ 4 Hz (depending of the configuration)	
wavelength	1500 – 1600nm	
working temperature	15 – 30° C / 5 – 45° C	

\*: all specifications given with an average operating mode of 10 acquisitions.

Note 1: For the central wavelength: 120 λ for the HASO NIR 32, 180 λ for the HASO NIR 40.

Note 2: wavefront directly measurement by the wavefront sensor (no added lens).

Note 3: difference between a referenced wavefront and the measured wavefront, in a range < 10 λ.

## SOFTWARE

### Wavefront acquisition (standard software)

Absolute (factory calibration) or referenced (user calibration) mode – one-shot or flying acquisition – camera signal – background signal : save and subtract in real time – for the sensor adjustment : tilt visualization ; manual adjustment of integration time.

### Wavefront reconstruction (standard software)

Wavefront display (unit in microns or lambda) : 3D, 2D projection, fines mode, xy profile, save function (text or excel format, comments) – display in real time with or without tilt and/or focus and/or 3<sup>rd</sup> order aberrations – intensity display : 3D, 2D projection, xy profile, save function (text or excel format, comments) – reconstruction : zonal or modal (Zernike or Legendre) – pupil shape : with or without central occultation.

### Wavefront : other tools (standard software)

Location (x y z) of the focus point – polynom coefficient display (unit in microns or lambda), historic function : display of the time changes of 4 coef. – local slopes display : with or without tilt and focus, zoom, rms and pv of the slopes - pupil calculation : automatic or manual (save and load functions) – spot diagram in real time for various observation positions.

### Point Spread Function measurement (PSF software)

PSF display : 3D, 2D projection, xy profile – parameters : best focus plane, user specified plane, focal plane of ideal lens – zoom (1 to 8) – Strehl ratio – numerical value in table - save and load functions (text or excel format, comments).

### MTF measurement (MTF software)

MTF display : 2D, x profile (user choice) – parameters : best focus plane, user specified plane, focal plane of ideal lens – zoom (1 to 8) – historic function : display of the time change of a specified frequency - save and load functions (text or excel format, comments).

### Laser characterisation (M square software)

Beam location, dimension and position of the waist – display of the beam shape – M<sup>2</sup> calculation – calculation of intensity shape in any plane - save and load functions (text or excel format, comments).

### Coupling efficiency (Preliminary)

Beam location, dimension and position of the waist – display of the beam shape – calculation of intensity shape in any plane, and comparison with dimension and aperture of the fiber - save and load functions (text or excel format, comments).

### Dynamic library

dll in C or VI for Labview : all the software functions to build specific soft applications.

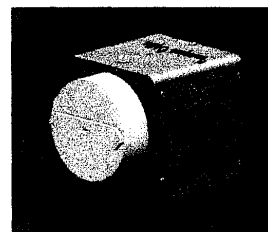



## HASO UV

*new wavefront sensor for UV applications*

### PRINCIPLE

*More Performant*

➤ **Optical wavefront sensor**

These wavefront sensors (Shack-Hartmann type) allow to obtain a map of local slopes of the analysed wavefront with the help of a microlenses array. This principle used for a long time in astronomy was amply improved as well on hardware as on software.

The CCD detectors reached the maturity and the necessary quality/price ratio to certify an irreproachable metrology with moderate prices; the fabrication of microlenses arrays has become reliable. The software innovations of Imagine Optic allow to use through optimal way this simple and direct measurement.

### APPLICATIONS

*Beam Analysis*

*Phase and Intensity*

*MTF*

*Characterization*

*Adaptive Optics*

➤ **Beams analysis in phase and intensity**

From 244 to 350 nm laser source: the HASO allows to measure optical quality, divergence, position and size of the waist,  $M^2$  parameter, Strehl ratio, astigmatism values, ...

➤ **Components and systems characterization**

Especially adjusted to middle size components (aperture of 5 to 12 mm), the HASO dynamic allows the analysis of small and large components too with divergent or convergent beam.

➤ **Focal length, MTF and point spread function measurement**

➤ **Adjustment, mounting, alignment**

The operator visualizes in real time the wavefront and some measured parameters, which show adjustments quality and allow to improve them (tilts and curvature values, space source position, third order aberrations which can move during an adjustment).

➤ **Active and adaptive optics**

Wavefront correction in real time with  $\lambda/10$ - $\lambda/20$  pv.

### ADVANTAGES

*Real Time*

*High Dynamic*

*Interactivity*

➤ **Achromatic and non sensitive to the coherence**

Particularly, monochromatic wavefront analysis.

➤ **Display and calculation in real time**

Adjustment and on-line control.

➤ **High spatial resolution**

Up to 2500 points measured in a standard configuration on the pupil.

➤ **Strong divergent and convergent beams analysis**

➤ **Wavefronts measurement in absolute or relative mode**

The HASO is factory calibrated. The measure is absolute except if a reference wavefront is specified.

## SPECIFICATIONS

	HASO UV 25	HASO UV 50
Aperture dimension	4,9 x 4,9 mm <sup>2</sup>	11,7 x 11,7 mm <sup>2</sup>
Number of sub-pupils dedicated for analysis	25 x 25	50 x 50
Dynamic measurement range by sub-pupils with tilt and focus	~ ± 3 λ	~ ± 3 λ
Tilt dynamic range	till ± 1,5°	till ± 1,5°
Focus dynamic range (1)	± 0,055 m to ± ∞	± 0,085 m to ± ∞
Maximum operating aperture (half angle)	0,04 (max)	0,07 (max)
Repeatability (rms)	~ 1,5 nm	~ 1,5 nm
Wavefront measurement accuracy in absolute mode rms (2)	~ 3,5 nm	~ 3,5 nm
Wavefront measurement accuracy in relative mode rms (3)	~ 2 nm	~ 2,5 nm
Tilt measurement accuracy	~ 0,5 μrad	0,5 μrad
Focus measurement accuracy	5.10 <sup>-4</sup> m <sup>-1</sup>	2,5.10 <sup>-4</sup> m <sup>-1</sup>
Spatial resolution	~ 200 μm	~ 230 μm
Acquisition frequency / processing frequency	~ 77 Hz / ~ 4 Hz	~ 200 Hz / ~ 10 Hz
Wavelength	244 – 350nm	
Working temperature	15 – 30° C / 5 – 45° C	

Note 1: For the central wavelength: 150 λ for the HASO UV 25, 470 λ for the HASO UV 50.

Note 2: wavefront directly measurement by the wavefront sensor (no added lens).

Note 3: difference between a referenced wavefront and the measured wavefront, in a range < 10 λ.

## SOFTWARE

### Wavefront acquisition

Continuous or ext. triggered mode – absolute (factory calibration) or referenced (user calibration) mode – one-shot or flying acquisition – camera signal – background signal : save and subtract in real time – for the sensor adjustment : tilt visualization ; manual adjustment of integration time.

### Wavefront reconstruction

Wavefront display (unit in microns or lambda) : 3D, 2D projection, fringes mode, xy profile, save function (text or excel format, comments) – display in real time without tilt and/or focus and/or 3<sup>rd</sup> order aberrations – intensity display : 3D, 2D projection, xy profile, save function (text or excel format, comments) – reconstruction : zonal or modal (Zemike or Legendre) – pupil shape : with or without central occultation.

### Wavefront : other tools

Location (x y z) of the focus point – polynom coefficient display (unit in microns or lambda), historic function : display of the time changes of 4 coef. – local slopes display : with or without tilt and focus, zoom, rms and pv of the slopes - pupil calculation : automatic or manual (save and load functions) – spot diagram in real time for various observation positions.

### Point Spread Function measurement

PSF display : 3D, 2D projection, xy profile – parameters : best focus plane, user specified plane, focal plane of ideal lens – zoom (1 to 8) – Strehl ratio – numerical value in table - save and load functions (text or excel format, comments).

### MTF measurement

MTF display : 2D, x profile (user choice) – parameters : best focus plane, user specified plane, focal plane of ideal lens – zoom (1 to 8) – historic function : display of the time change of a specified frequency - save and load functions (text or excel format, comments).

### Laser characterisation

Beam location, dimension and position of the waist – display of the beam shape – M<sup>2</sup> calculation – calculation of intensity shape in any plane - save and load functions (text or excel format, comments).

### Dynamic library

dll in C or VI for Labview : all the software functions to build specific soft applications.



Imagine Optic - 18, rue Charles de Gaulle - 91400 Orsay - France  
Tel : 01 64 86 15 60 – fax : 01 64 86 15 61 - e-mail: [contact@imagine-optic.com](mailto:contact@imagine-optic.com)



## 10" SCHMIDT-CASSEGRAIN TELESCOPE CHARACTERISATION THANKS TO A SHACK HARTMANN WAVEFRONT SENSOR

**Charles Brossollet, Jérôme Ballesta, Laurent Couvet , Guillaume Dovillaire**  
*Imagine Optic, 18 rue Charles de gaulle, 91400 Orsay, France*

### *Abstract*

*HASO (Shack-Hartmann wavefront sensor manufactured by Imagine Optic) is in part dedicated to optical system metrology. Its wide dynamic and its easy to use and to integrate approach allow this sensor to characterise a wide range of dioptricals and catadioptricals systems. This document will present how to make a wide aperture optical system characterization with an HASO+LIP. Results will be also presented and effects of misalignment on the WFE will be appreciated.*

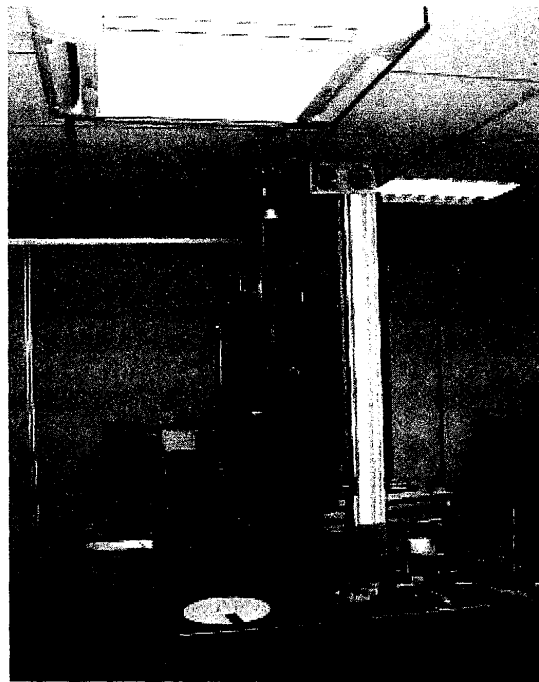

*For more technical or commercials information please contact us*  
[contact@imagine-optic.com](mailto:contact@imagine-optic.com)

## 1. Set up description

This application shows how to measure Schmidt-Cassegrain WFE with a HASO plus LIP upgrading system. The illuminating beam is adapted to the numerical aperture of the telescope thanks to a lens ( $f/10$ ). As the telescope has got 10" aperture, a 8"  $\lambda/150$  rms flat mirror has been used for the autocollimation.

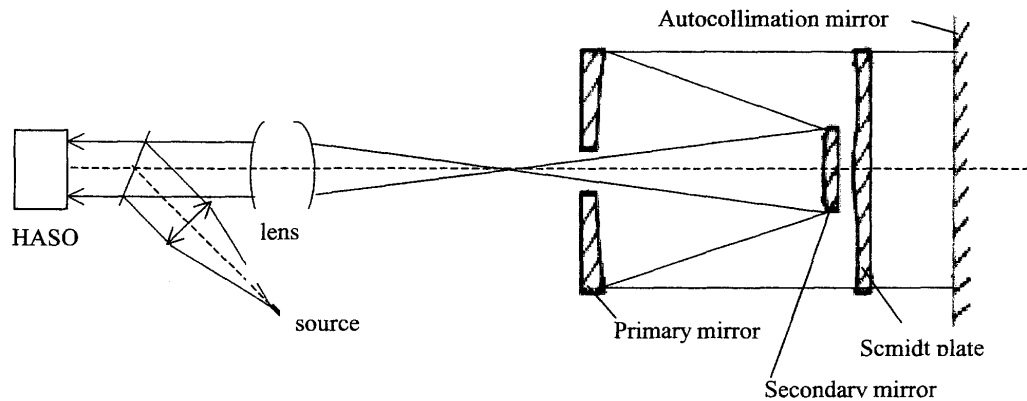

## 2. Measurement description

First of all the measurement the set up must be calibrated and. Here a better than  $\lambda/150$  rms flat mirror<sup>1</sup> has been used for the autocollimation and the whole process has been done vertically. A perfect sphere has been used for the HASO+LIP calibration. In this configuration, WFE measurement accuracy was better than  $\lambda/50$  rms. Please find below the procedure for the Telescope characterisation:

1. **Calibration of LIP thanks to a perfect sphere ( $\lambda/150$  rms). Saving of the LIP's WFE file**
2. **Alignment of the LIP in front of the telescope (rotation of the flat mirror).**
3. **Measurement of the telescope's WFE in referenced mode (using the data file described in 1).**

---

<sup>1</sup> This mirror will limit the accuracy of the measurement. Several tests allow to check its flatness.

### 3. Results

#### 3.1 Before Alignment

HASO.exe displays shown us that a field aberration was. In fact a misalignment of the secondary mirror introduced coma when the Lip was illuminated the system aligned on the mechanical axis.

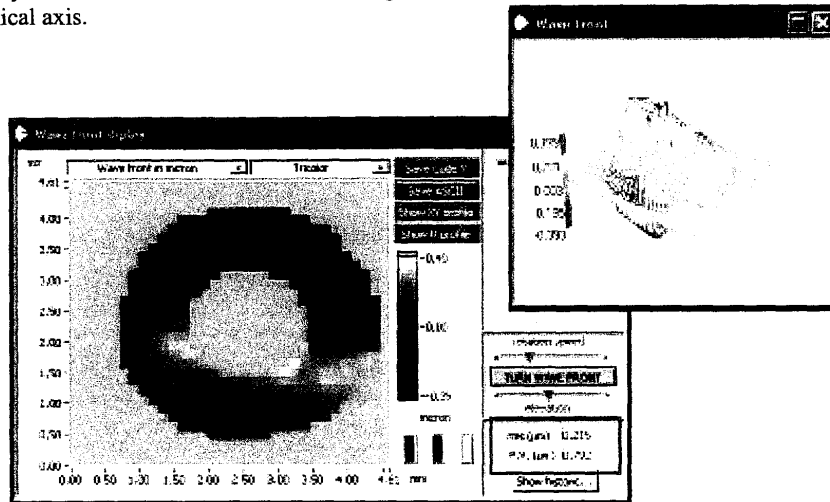

#### 3.2 After Alignment

Real time measurement allow us to process the alignment of the whole system. The secondary mirror was aligns on the primary in order in reducing to 0 field aberrations.

WFE both rms and PV value allow us to appreciate the effect of the alignment. With a such accurate wavefront measurement a lot of processing are reachable, and then it's possible to calculate MTF of the system for example.

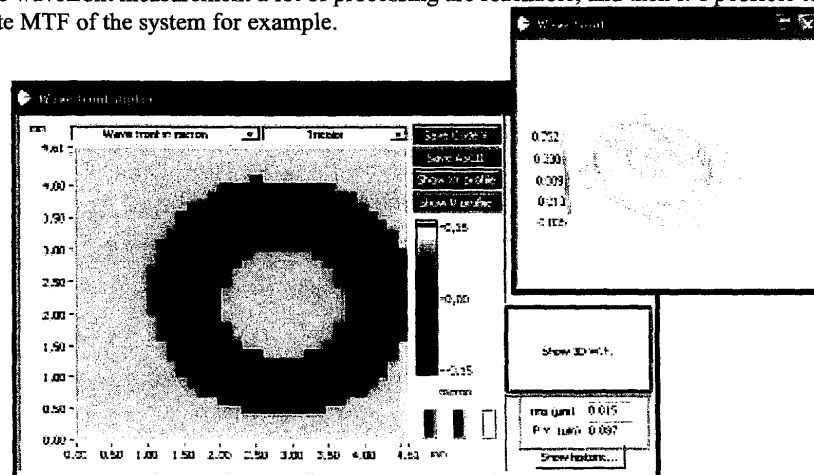



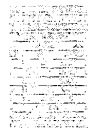

1999

# HIGH-TECH IN GLASS.





## KNOW-HOW AT THE CUTTING EDGE.

We're an innovative, modern company with outstanding know-how like our advanced ion beam polishing process. Our technological resources are complemented by CNC machines specially developed for precision glass processing, modern thin film sputtering technology, and precision measuring techniques.

Quality, innovation, reliability, and flexibility: they're not mere mottos but the yardsticks by which we measure our success.

In close co-operation with our customers, we develop individual solutions for special technological challenges – and accompany every project from start to finish with our expertise and advice.

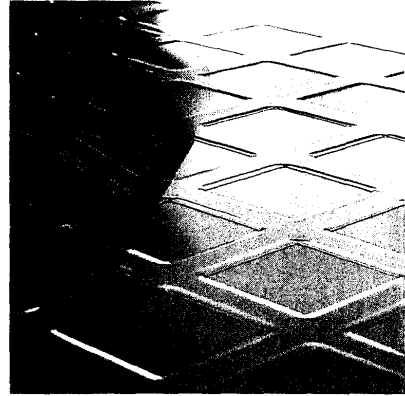

In every phase of cooperation we maintain an intensive dialogue and teamwork with our customers. This ensures maximum flexibility throughout development, production, assembly, adjustment, and certification.

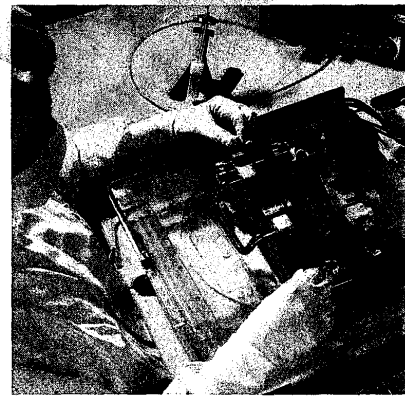



## SAFEGUARDING PRECISION.

Seeing, protecting, measuring, guiding, converging, dispersing, reflecting, recording – accurately, precisely, reliably – with glass and comparable materials. The Berliner Glas workforce in Germany, Switzerland, and the United States are the guarantee for success.

From the idea through prototype development to series production, 630 highly skilled men and women give their best.

Committed teams of experienced experts from a wide range of specialized fields work on customer-orientated optical solutions – flat, cylindrical, spherical and aspherical – in the spectral ranges EUV, DUV, UV, VIS, NIR.

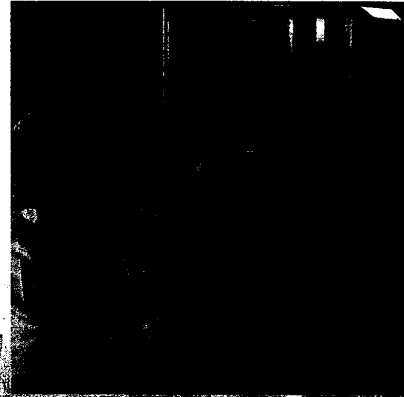

Glass components are produced and developed in optical and mechanical design, manufacturing, site of optical coating, and adjustment of components, assemblies and the finishing of glass for technical applications. We also produce individual measuring systems.

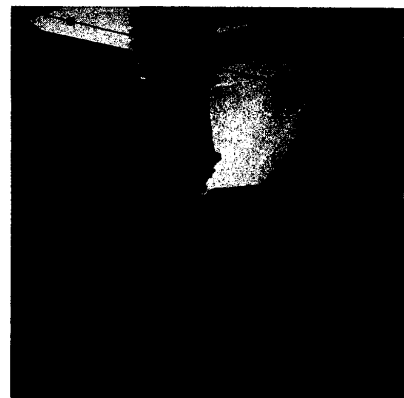

The precision shaping and surface finishing of glass and similar materials for demanding technological uses is our core business.

Production and measuring processes are constantly being developed and refined to ensure a wide range of cutting-edge applications for our products.

Safeguarding precision is our profession.

To keep it that way, our staff receives ongoing training in comprehensive programs. We have a network with research institutions, suppliers and customers.

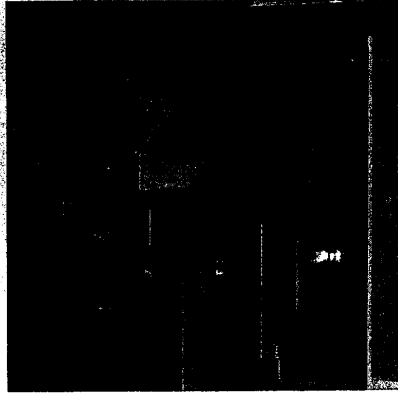
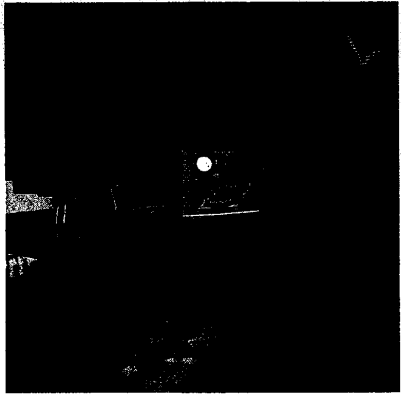
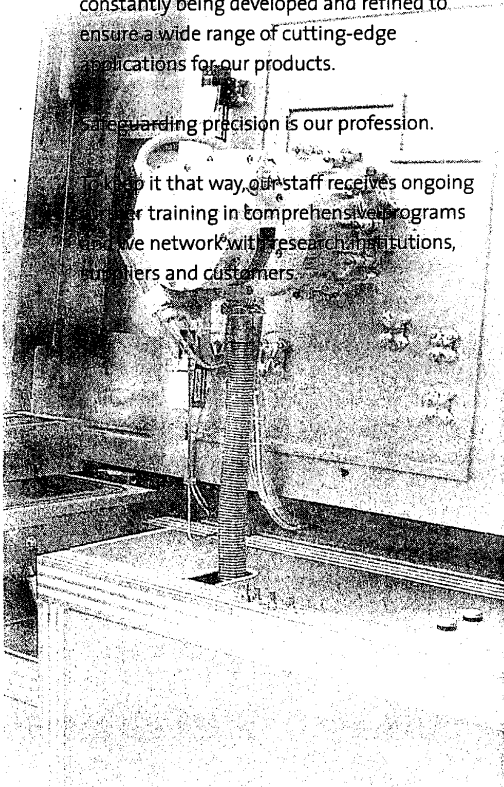



## FORM FOLLOWS FUNCTION.

The application and purpose of a glass component alone determine its form – the finishing of shaped glass optimizes its functionality.

We offer technical glass for any conceivable application – mirrors or two-sided antireflection-coated glass for pictures, scanners, auxiliary TV screens or large-screen projectors.

We shape glass and glass ceramics with computer numerical control (CNC) processing centers. Parts can be created for entirely new functions with a high degree of precision and reproducibility.

Our screen printing process permits highest quality printed images on glass and ceramics, metal and composite materials for measuring instruments or design elements.

We can produce glass surfaces in various degrees of roughness and/or gloss structures both chemically and mechanically.

For protective glasses or pressure-loaded display devices we offer flat or curved, single thickness or laminated safety glass. The glass is bonded as required under pressure and heat with transparent high-performance films – which can perform additional functions.

We update our production processes continuously and we're proud of the results.

For standard and custom optical lenses, line-to-standard, printing, precision optics and peak-to-valley heights, we also produce customized etching structures to meet the transmission and reflection requirements of a given glass.

Optimized, product-specific measuring processes subject all work to constant scrutiny.

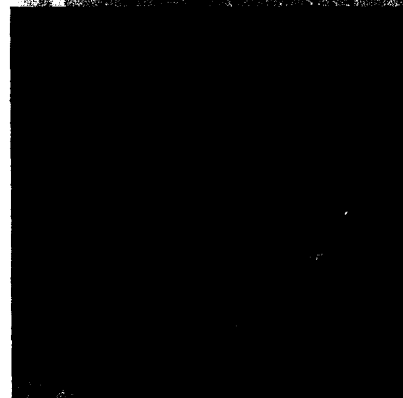
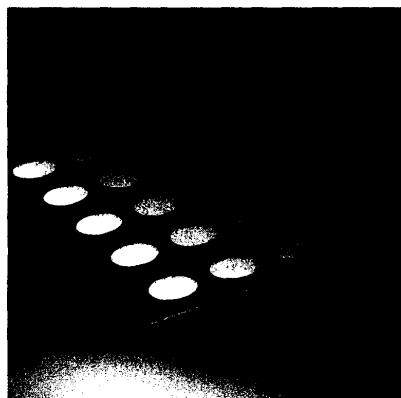

PRODUCTION:

- Edge processing
- Chemical strengthening
- Screen printing
- Laminating glass and various materials
- Sand blasting
- Etching
- Bending
- Thermal moulding
- CNC shaping, grinding and drilling

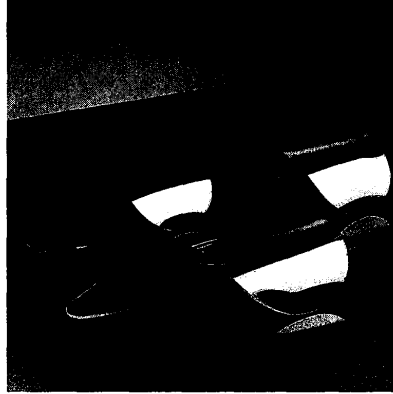

INSPECTION:

- Thickness and pinhole measurement
- Interferometer
- Coordinate measuring machines
- 3D surface measurement
- Roughness measurement
- Glass measurement systems

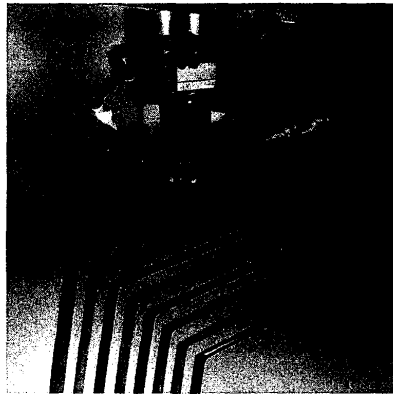
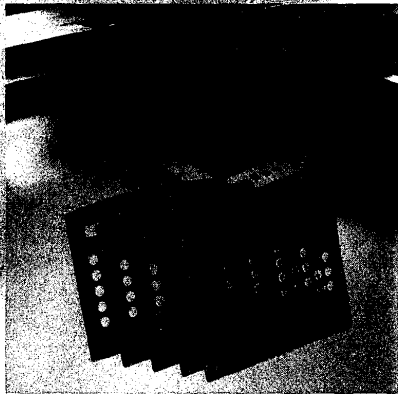
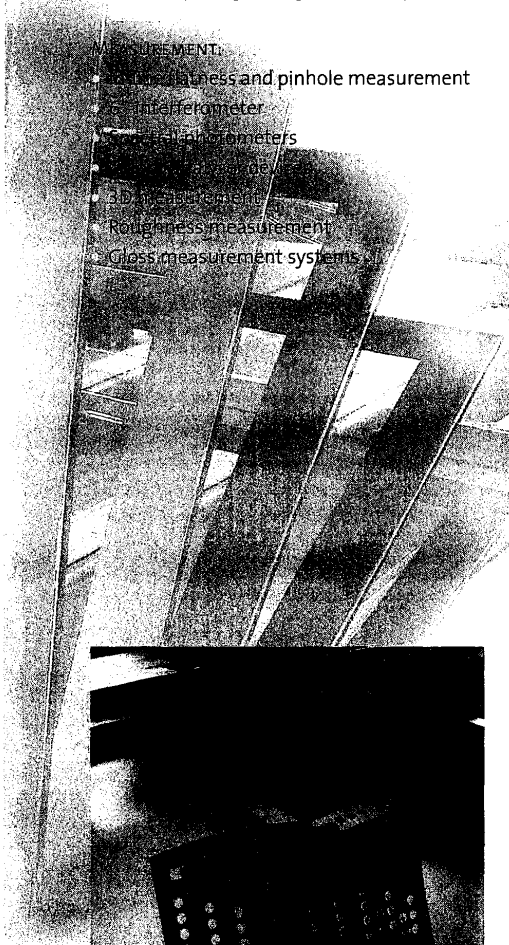
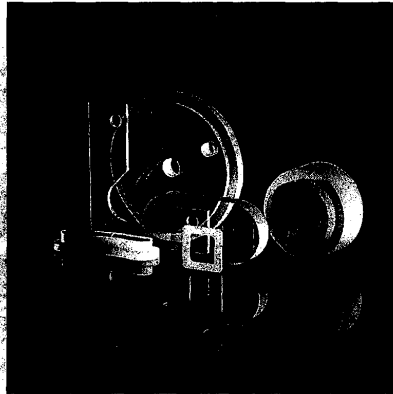



## THE INTELLIGENCE OF LIGHT.

Optical systems determine the path of light. They bundle and disperse, direct and reflect, reduce and enlarge, record and reverse.

Optic solutions are our specialty – from consultation to design, development and production. And for a vast range of applications whether flat or round, cylindrical, spherical or aspherical, complex modules, multifunctional or unmounted systems. Many different materials are used: glass, ceramics,  $\text{CaF}_2$ ,  $\text{MgF}_2$ , germanium, silicon and diverse special materials.

Precision is our forte: we achieve flatnesses of  $\lambda/30$  pv, owing especially to optimized ion beam processing. And we achieve surface roughnesses of  $\text{RMS} \approx 0.4$  nm and less.

Optical substrate coating makes light into a tool. Reflection is reduced, rays directed, mirrored or filtered.

Thin film technology in state-of-the-art processes ensures impeccable results in silvering or antireflection coating for various materials and layer thicknesses – according to customer requirements. This applies also to the manufacture of graduated or non-graduated filters.

We make the greatest demands on mounting and assembly adjustment, which is predominantly restricted to the clean room. This is where, for example,  $\text{CaF}_2$  assemblies for excimer laser are produced.

High quality requires constant control. The individual development of appropriate measurement setups and software adaptation are therefore a matter of course. With test certificates, documented measurement results and thus guaranteed measured precision.

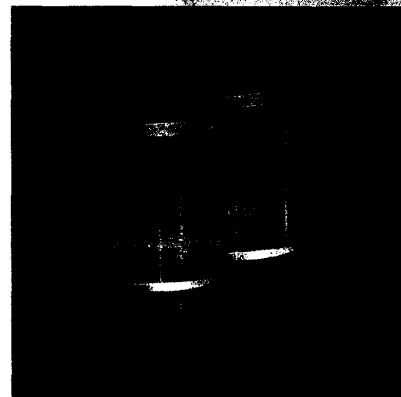

DEVELOPMENT AND DESIGN:

- Optical design
- Mechanical design
- Product development
- Design of measurement set-ups

PRODUCTION:

- Grinding and polishing of
  - optical glass
  - glass ceramics
  - synthetic quartz
  - natural quartz
  - CaF<sub>2</sub>, MgF<sub>2</sub>
  - silicon
  - germanium
  - special materials
- Fine correction techniques
  - ion beam
  - mechanical
- CNC shaping
- CNC centering
- Thin film coating
- Micro-structuring
- Clean-room mounting and adjustment of
  - electro-optical and optomechanical
  - instruments

MEASUREMENT:

- 4" to 24"-interferometer
- 3D measurement (CNC-controlled)
- Sub-nanometer surface roughness test
- AFM power microscope
- Goniometer
- Shack-Hartmann wave front sensor
- Spectral photometer
- Spherometer
- Computer-supported MTF measurement
- Focus measuring device "Optomatic"
- Video precision measuring technology (Smart Scope)

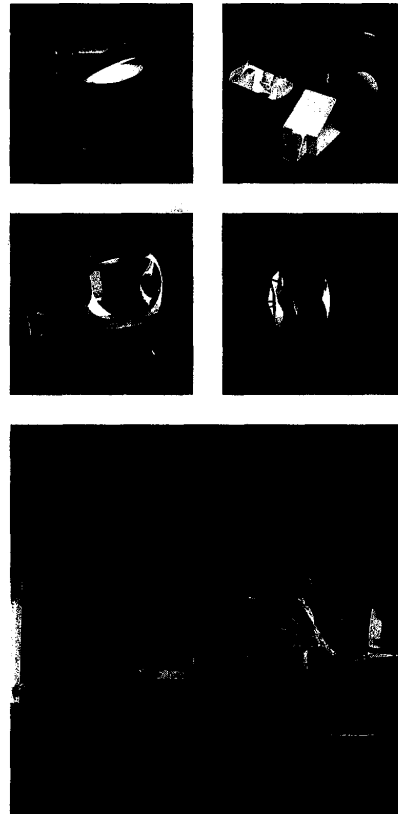
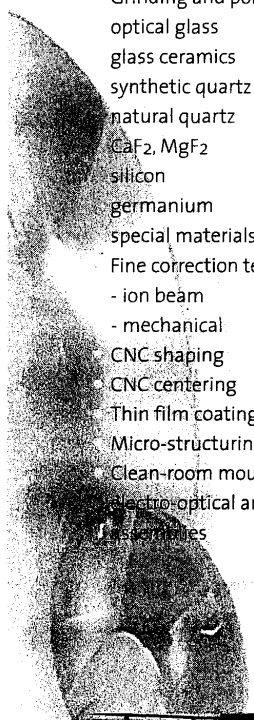



# Enter into the fascinating World of High Performance Optics



Solutions in optics

**and discover the special capability of SwissOptic ...**

 swissoptic

R & D and Production  
Technology

# Peak Performances require advanced experience and know-how.

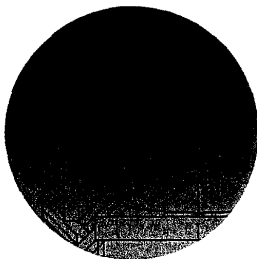
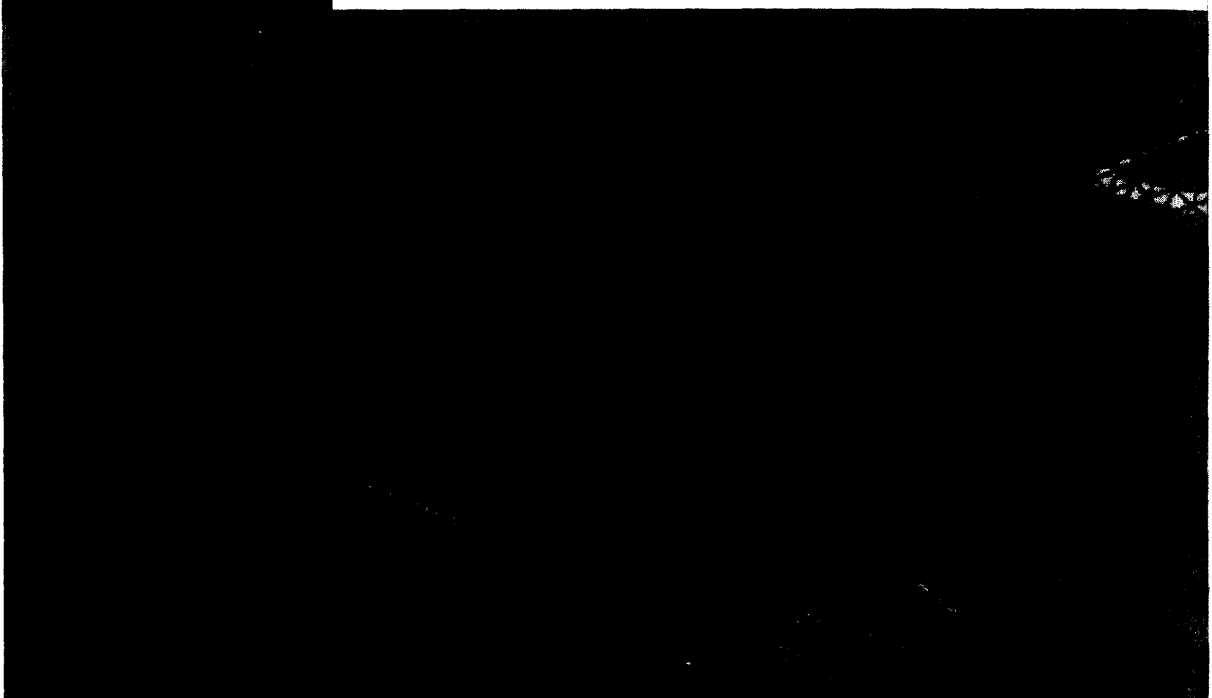

Your highly demanding tasks will be translated into a full process chain where consultancy, design, engineering, production, testing and documentation can be offered to you. A know-how gathered during several decades and most modern technology allow us to be your all-round partner for optical solutions.

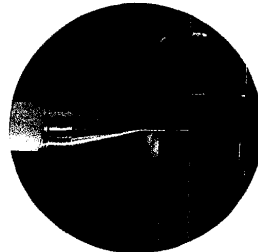
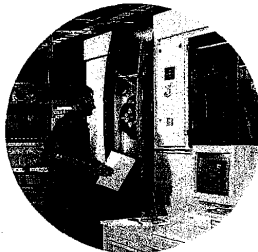



**R & D and Production Technology are areas which offer many novel ideas to you. Please discuss your project with us!**

#### **R & D**

Development of optical components, subassemblies and systems in the spectral ranges UV, VIS, NIR and FIR

#### **Optical components**

- Transmissive and reflective components in the diameter range of 2 to 500 mm
- Multifunctional and monolithic components; several mechanical and optical functionalities are integrated into one glass component.
- R & D and production of thin-film coatings

#### **Subassemblies and Systems**

- Multifunctional optical sensor systems
- Optical Systems of highest precision for a large variety of applications.

#### **Capabilities**

- Optical design and tolerancing
- Opto-mechanical design
- R & D of thin-film coatings
- Finite element analyses
- Environmental simulations
- Prototyping
- Measuring Technologies
- Understanding of International Standards such as MIL, DIN, ISO
- System optimisations based on efficient production technology
- Quality testing devices

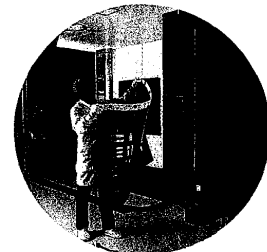

# Innovative solutions are made possible by complex shaping.

Plano Optics

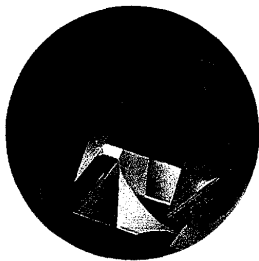
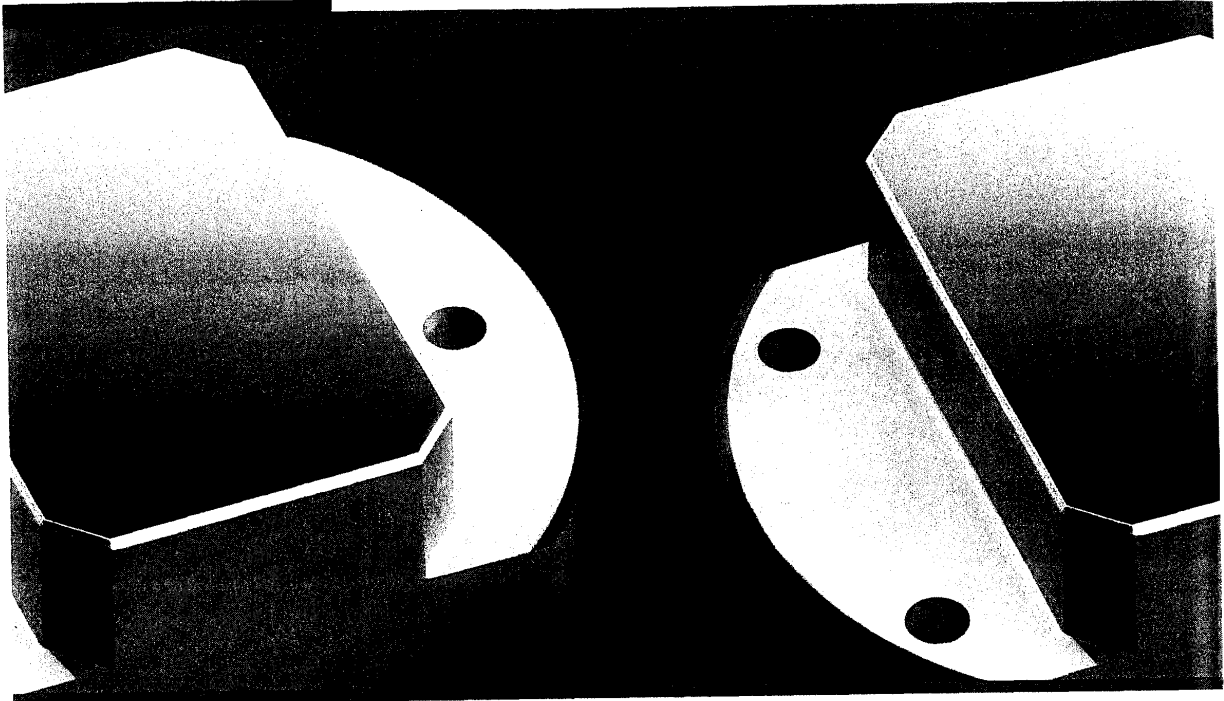

Modern CNC-Technology adapted to the needs of modern optical production is our answer to new and unique demands in the field of high-tech optical engineering. One single glass component can integrate several optical and mechanical functions. These fascinating opportunities are part of our daily work.

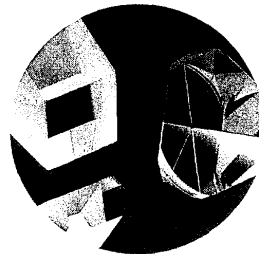
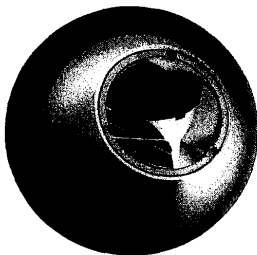

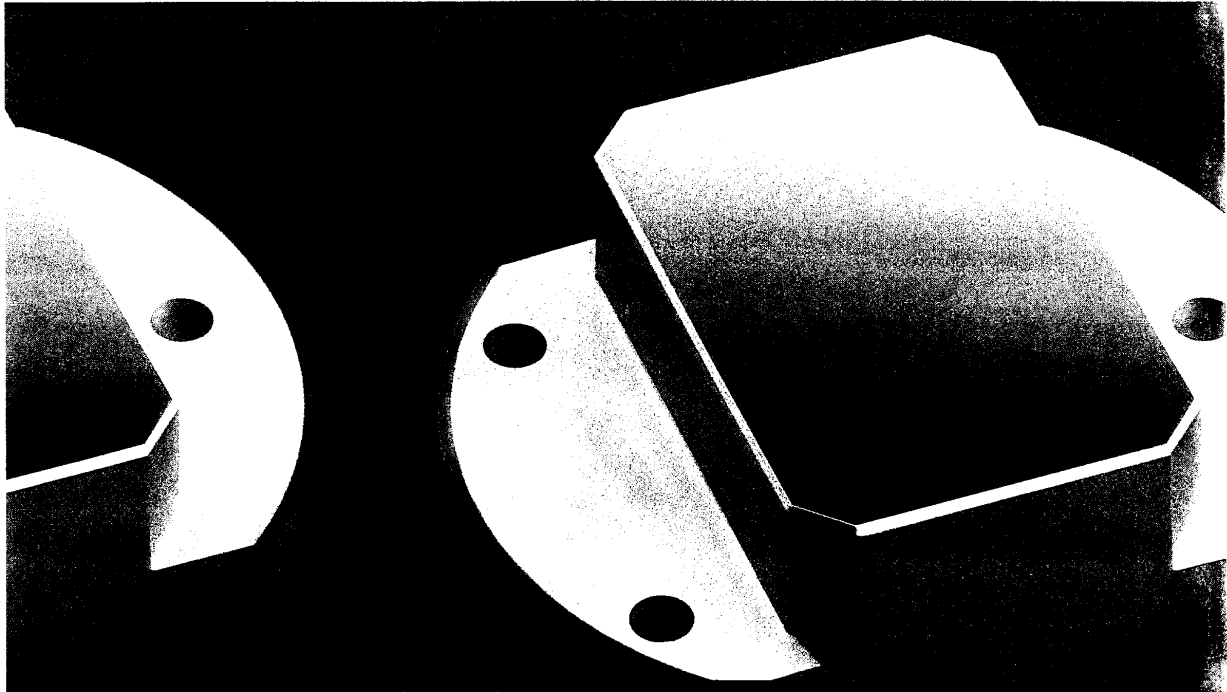

**Multifunctional and monolithical components make the most novel designs possible, especially in plano optics.**

**Some technical data**

- Processing of different optical materials, such as glass, fused silica, ceramics, germanium, CaF<sub>2</sub>,...
- Angular accuracy up to 1"
- Parallelism up to 1"
- Flatness up to  $\lambda/30$  at  $\lambda = 633$  nm
- Typical dimensions 2 to 500 mm
- High-precision cementing
- Micro-roughness up to 2 Å RMS

**Novel design possibilities due to CNC-manufacture of components**

- Manufacture of complex shapes in glass, fused silica, ceramics
- Several mechanical functionalities integrated into one optical component (multifunctional optics)
- Several optical functionalities integrated into one optical component (monolithical optics)
- Design of components adapted to assembly requirements
- Reduction of number of components in a system

- Integration of fixture devices
- Uniformity of expansion coefficients
- Reduction in volume and weight

**Some typical plano-optical components**

- Filters
- Plano-parallel plates
- Wedges
- Dove prisms
- Pentaprisms
- Polygons
- Roof prisms
- Schmidt/Pechan prisms
- Windows
- Corner cubes
- Beamsplitting plates & cubes
- Inverting systems

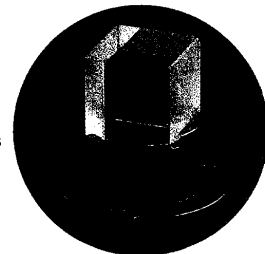

# Enthusiasm for dimensions beyond the common.

Spherical Optics



A knowledge beyond pure optics and an understanding for the final application are qualifications required for the development and manufacture of high-tech spherical optics. Our specialised staff and latest CNC manufacturing technology assure extraordinary performances.

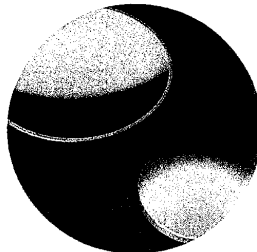



**Top quality spherical optics for outstanding insights and outlooks.**

**Some technical data**

- Lens diameters from 2 to 500 mm
- Radii from 1.2 mm to  $\infty$
- Irregularity up to  $\lambda/30$  PV at  $\lambda = 633$  nm
- Centering accuracy  $10''$
- Center thickness tolerance  $\pm 5 \mu\text{m}$
- Diameter tolerance  $\pm 5 \mu\text{m}$

**Additional information**

- Various materials being processed, such as Glass, Fused Silica, Germanium, Silicon, other special materials
- Single and compound lenses
- Special know-how in optical cementing
- Lacquered diaphragms, lacquered circumferences
- Special shaping of contours
- High-precision aspherical components, on and off-axis

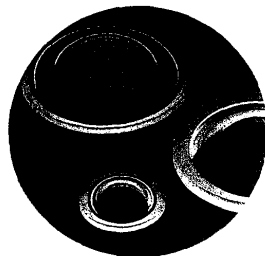

# Finest precision created by most modern technologies.

Microstructured patterns and thinfilm coatings

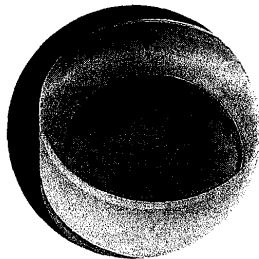
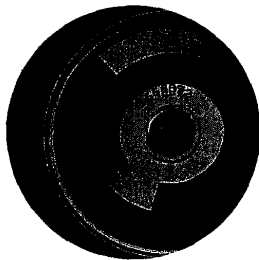
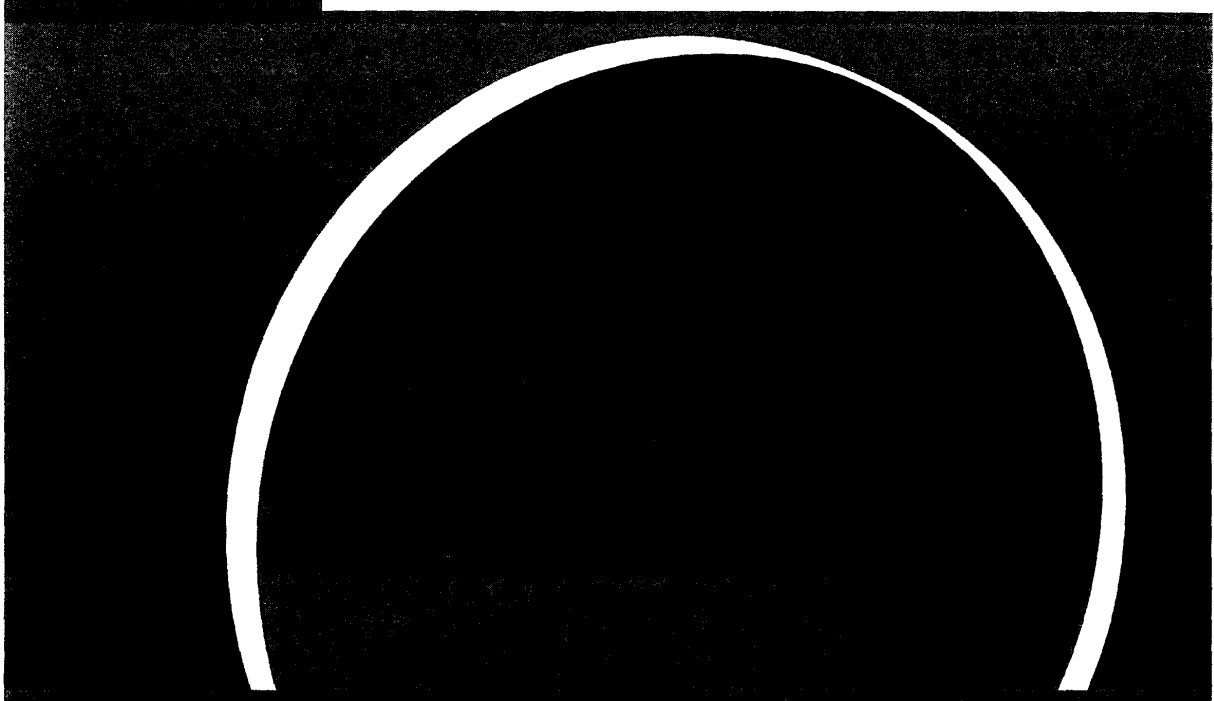

Complete solutions integrating microstructured patterns and coatings are very sought-after. Our offer to you includes also consultancy, R & D and documented measuring results. Very sophisticated manufacturing procedures deliver also a high-volume output with constant quality and extremely high precision.

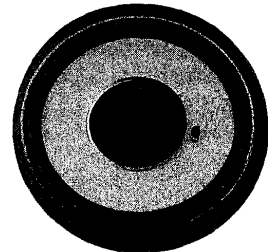
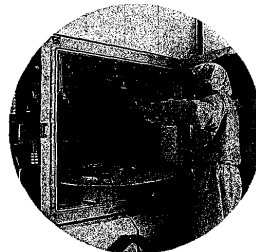



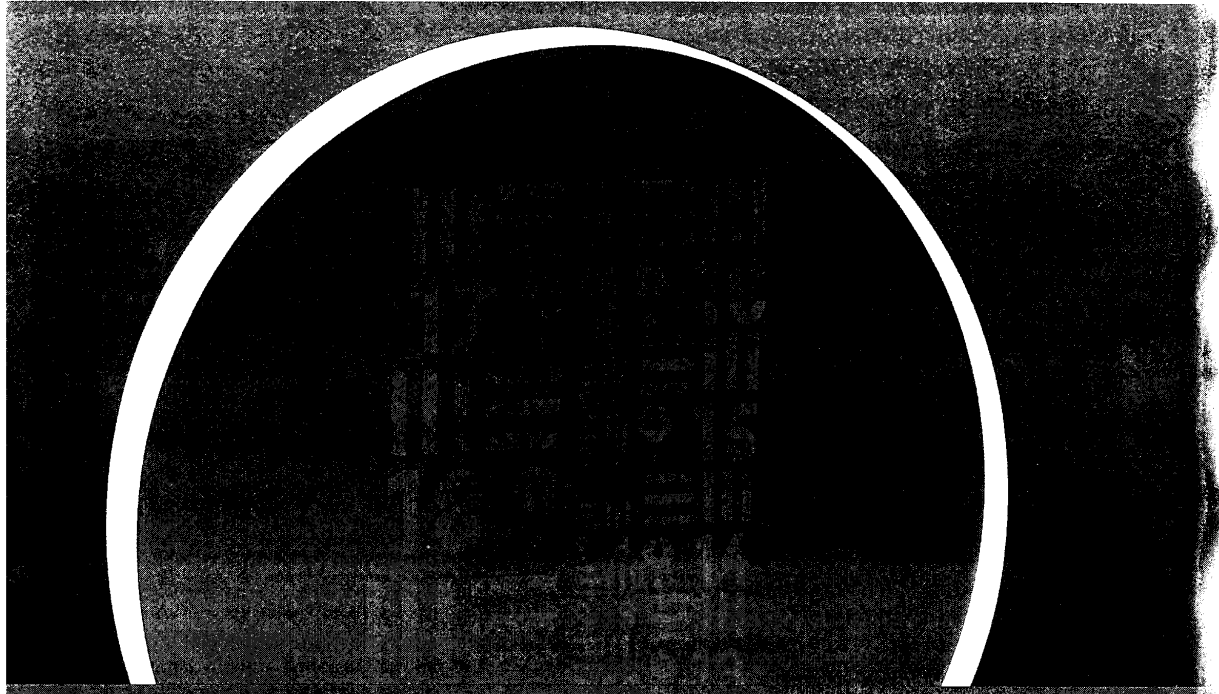

**Optical components with microstructured patterns and coatings at the limits of feasibility.**

**Reticles, masks, diaphragms**

- Diameters from 2 mm to 140 mm
- Line width  $> = 1 \mu\text{m}$
- Line precision up to  $0.5 \mu\text{m}$
- Black, etched or luminescent

**Circles**

- Encoded circles
- Graduated circles

**Gradient filters**

- Continuous or customer-specific behaviour curve

**Coated patterns**

- Mosaic filters
- Customer specific patterns

**Spectral ranges**

- DUV, UV, VIS, NIR, IR

**Antireflection Coatings**

- Broadband AR
- V-coatings; Reflection  $< 0.1 \%$
- Dual-Band-Coatings

**Filters and Mirrors**

- Long pass filters
- Short pass filters
- Narrowbandpass filters
- Heat protection filters
- Cold mirrors
- Metallic or dielectric mirrors
- Laser mirrors

**Beamsplitting Coatings**

- B/S cubes
- B/S plates
- Polarisers
- Unpolarising B/S coatings

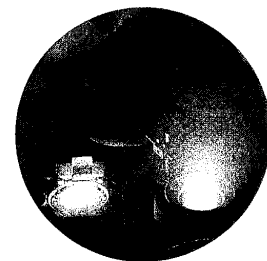

# Seeking for intelligent solutions with new combinations ...

Subassemblies  
and Systems

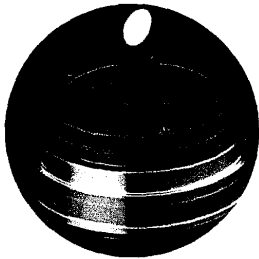
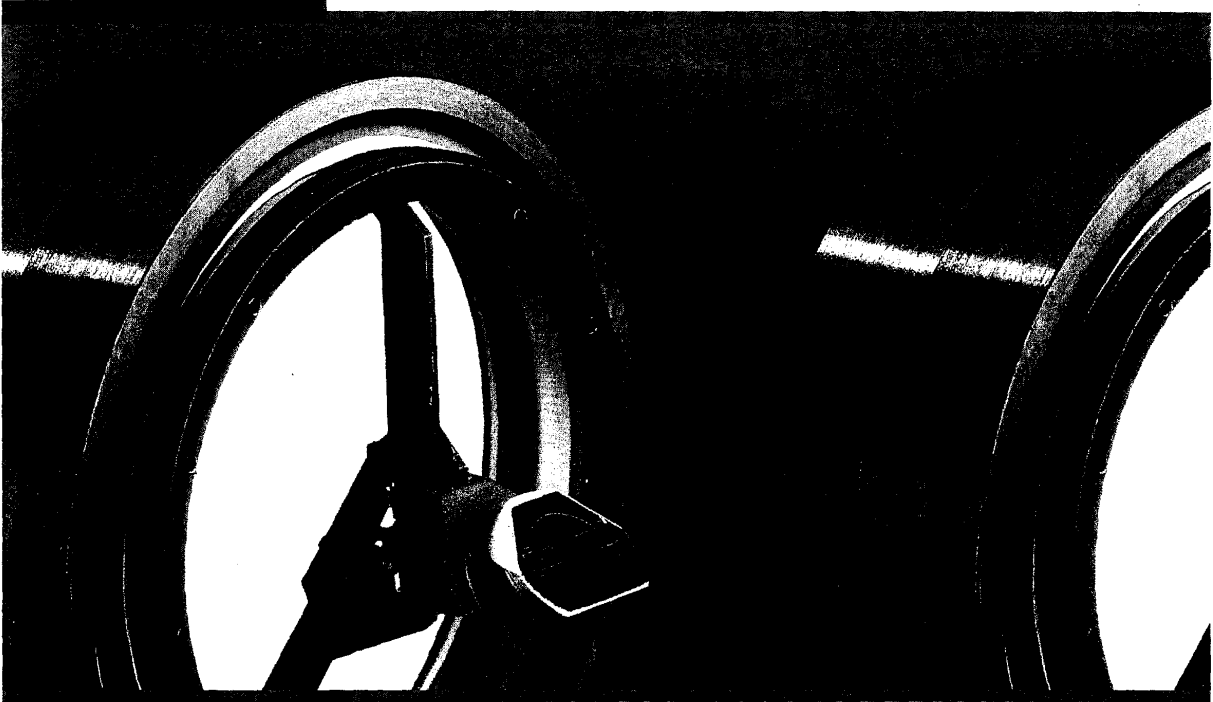

The combination of components, assemblies and modules, leading to high-tech optical systems, is one of our strengths. Carefully finished and tested components, an inventive spirit, technical know-how and an excellent infrastructure are our advantages leading to convincing optical solutions.

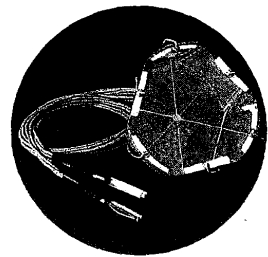
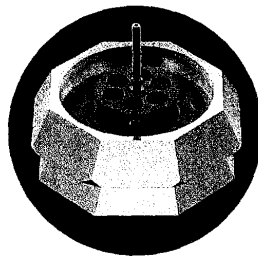
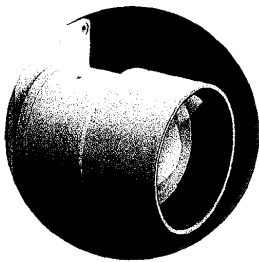

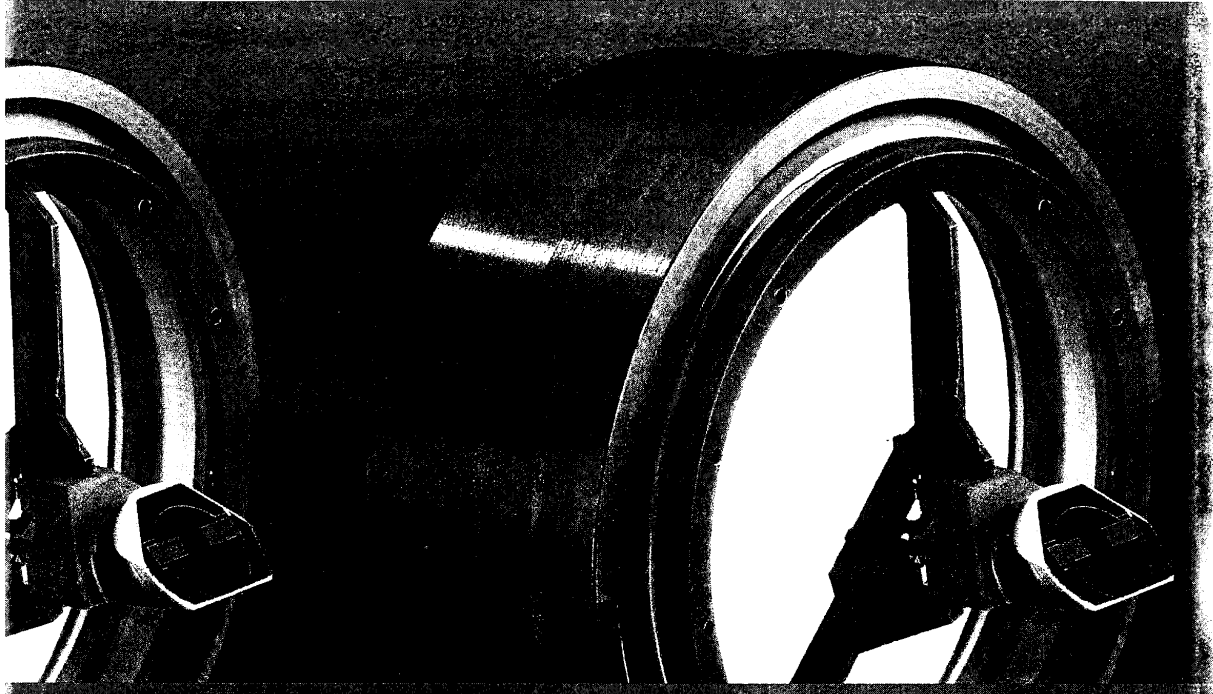

**Complex optical systems for the most demanding applications result from high-tech assembly of individual components.**

#### **Complete Solutions**

- Assembly of optical components, mechanical mounts and electrical components
- Assembly of systems
- System testing and documentation



#### **Assembly-related know-how**

- Gluing
- Clamping
- Lacquering
- Adjustment/Alignment
- Ball chuck centering; centering precision up to 2  $\mu\text{m}$
- Assembly of lens systems; diameter range 2 to 300 mm
- Cleanroom assembly (Flow-boxes)
- Ultrasonic welding of plastics to glass
- Ultrasonic cleaning of optics and mechanics

#### **Measuring Technology**

- Computer based MTF-measurements
- Interferometrical measurements
- Microscopical image resolution tests
- Wavefront measurements by means of Shack-Hartmann sensor
- Measurements by means of goniometers
- Testing of gastightness of assemblies

**Please come to test our Efficiency.**

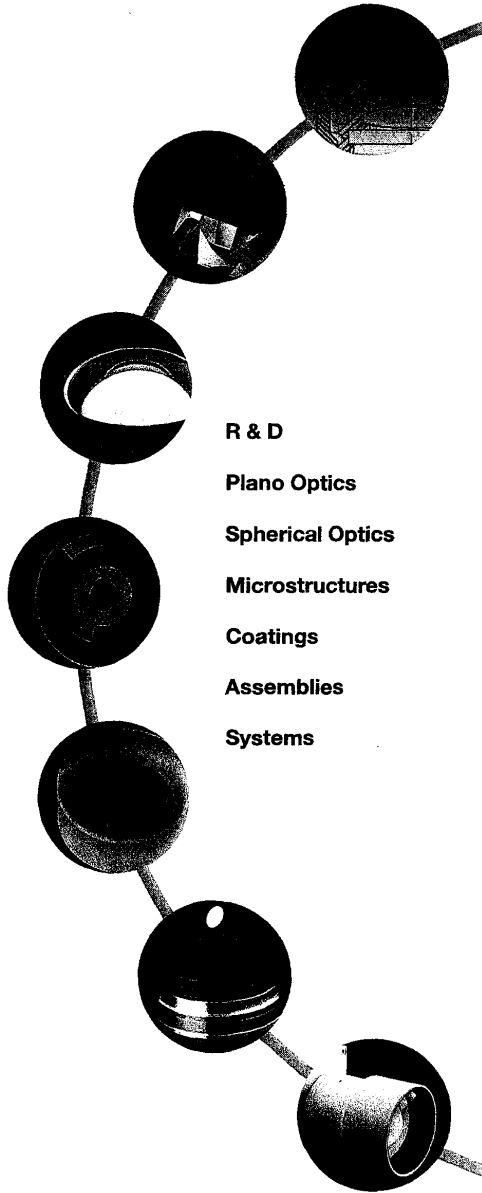

**R & D**

**Plano Optics**

**Spherical Optics**

**Microstructures**

**Coatings**

**Assemblies**

**Systems**

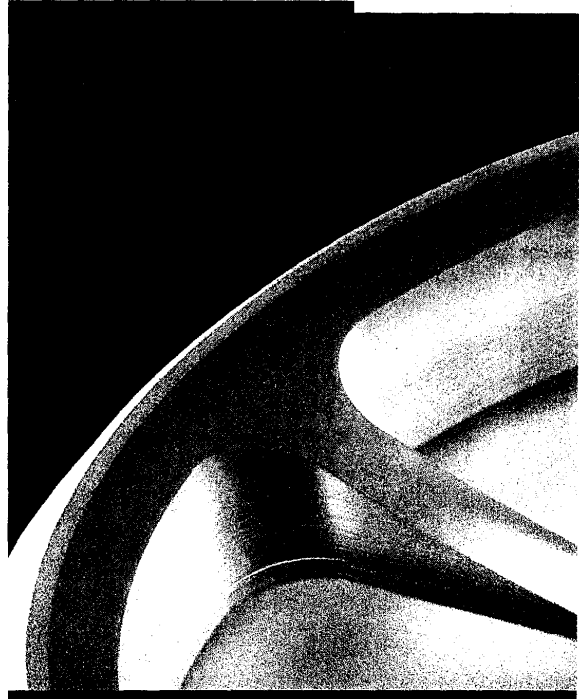

**Products that integrate optics from SwissOptic are our best references. Your demand will be welcome for detailed discussions beyond this brochure ...**



**[www.swissoptic.com](http://www.swissoptic.com)**  
**Solutions in optics**

SwissOptic AG . Heinrich-Wild-Strasse . CH-9435 Heerbrugg (Switzerland)  
Tel +41 71 727 30 74 . Fax +41 71 727 46 86 . e-mail: [swissoptic@swissoptic.com](mailto:swissoptic@swissoptic.com)

LEISTER®

LEISTER Microsystems

micro-optics

imagine the future of light

**LEISTER**  
Microsystems

## From components

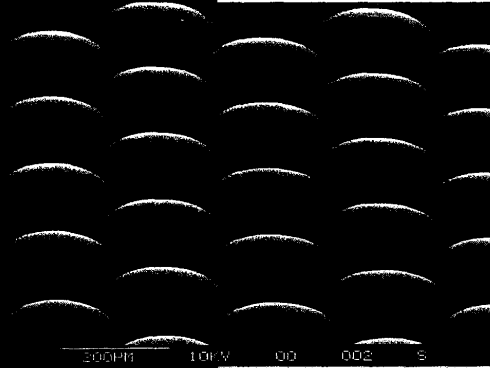

*Refractive lens arrays are provided in a range of diameters and focal lengths.*

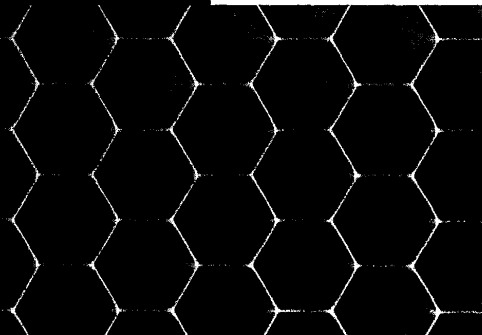

*Hexagonal lens arrays provide very high fill factors with minimal space between the lenses.*

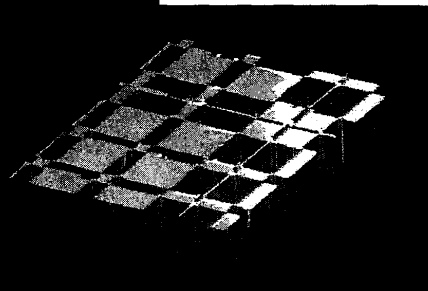

*Diffractive fan-out structures are used for multiple beam generation.*

LEISTER Microsystems

LEISTER Microsystems provides a range of standard and customer defined optical microstructures. These include:

- refractive microlens arrays and
- diffractive structures

which are used either as stand-alone items or as enabling components for advanced optical systems. Micromechanical structures such as V-grooves complement these structures as building blocks for micro-optical systems.

### Optical functions

- Collimation
- Fiber coupling
- Beam steering
- Beam shaping
- Diffusing
- Beam homogenizing
- Fan-out / beam splitting

### Materials

To provide an optimal solution for your needs our micro-optical components are available in a range of materials, including:

- Fused silica
- Silicon
- Plastics
- Polymer on glass / silicon / GaAs

## for applications in:

- Telecom
- Displays
- Data storage
- Imaging

## → to solutions

We start with your early ideas to design optimized micro-optical components and systems to suit your needs.

Whether you need rapid prototyping or large volumes of micro-optics our varied in-house fabrication technologies, combined with external partnerships, allow us to offer you a reliable production solution for your micro-optical devices.

### Design

- Optical design and modelling

### Fabrication

- Prototyping and small volume manufacturing
- Large volume fabrication
- Replication on custom specific substrates and parts

### Systems

- Stacked arrays
- MOEMS capabilities
- Custom specific developments
- Assembled subsystems

- Laser material processing
- Metrology
- Optical sensors
- Biomedical

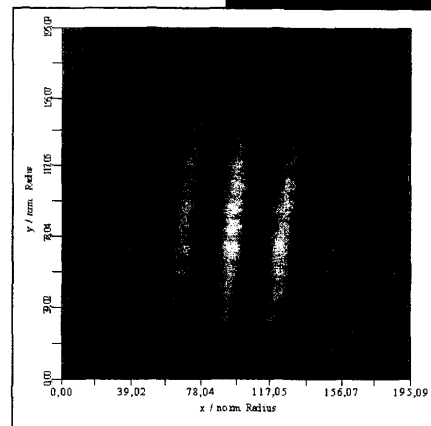

*The ability to measure micro-optics is crucial to achieve a quality product. The interferogram shows a microlens with diffraction limited quality.*

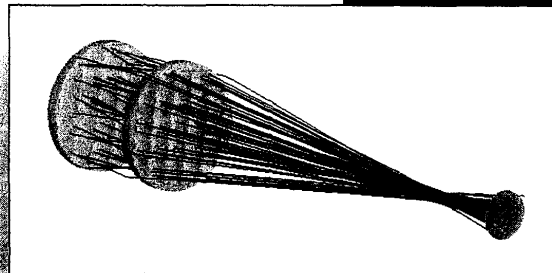

*Good optical design reduces overall development time and ensures optimized final systems.*

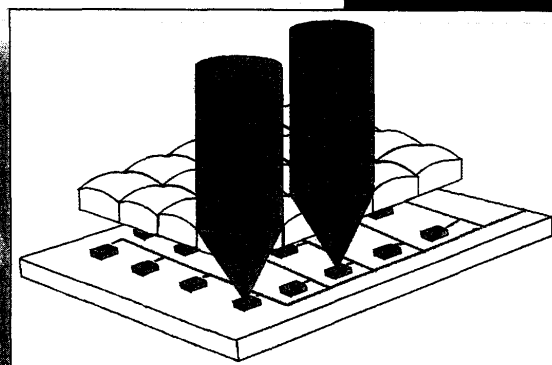

*An important application of microlens arrays is fill factor enhancement in CCD cameras.*



LEISTER Microsystems  
ISO 9001:2000

# Microlens Arrays

## Applications Include:

- Laser beam shaping
- Imaging systems
- Displays
- Sensors
- Fiber optics
- Lighting / illumination



## Microlens Array (MLA) Parameters

Array Size	up to 130 mm
Lens Aperture Size	10 $\mu\text{m}$ to >1.5 mm
Aperture Shape	Circular, Hexagonal, Elliptical, Square, Other
F-number	F/0.66 to F/ $\infty$ (NA $\leq$ 0.60)
Materials	Fused Silica, Silicon, Plastics

LEISTER Process Technologies offers high quality refractive microlens arrays in a wide range of focal lengths, aperture sizes, aperture shapes, lens spacing, and arrangements.

Our experienced optics design experts cooperate closely with customers to find optimal standard or OEM solutions for their requests.

Well-controlled ISO 9001:2000 certified production processes, with dedicated equipment and specialized characterization tools, combined with 50 years of manufacturing experience, make us a reliable supplier.

## Contact Information

### Headquarters

LEISTER Process Technologies  
Microsystems Division

Riedstrasse

CH-6060 Sarnen/Switzerland

Phone +41 41 662 74 74

Fax +41 41 660 20 61

e-mail [microsystems@leister.com](mailto:microsystems@leister.com)  
[www.leister.com](http://www.leister.com)

### USA

LEISTER Technologies, LLC

1253 Hamilton Parkway

Itasca, IL 60143/USA

Phone (630) 760 1000

Fax (630) 760 1001

e-mail [sales@leisterusa.com](mailto:sales@leisterusa.com)  
[www.leisterusa.com](http://www.leisterusa.com)

LEISTER Microsystems Exclusive Distributor





LEISTER Microsystems  
ISO 9001:2000

# Fiber Collimating/Coupling Lens Arrays

*Microlens arrays for collimating and  
coupling of single mode optical fibers*

## **Benefits**

- Standard 250  $\mu\text{m}$  pitch fiber array compatible
- Focal length uniformity  $< \pm 0.45\%$  lens-lens
- Uniform pointing performance
- High surface quality, very low roughness
- Fused Silica material, Telcordia compliant
- AR coating
- 100 % inspection

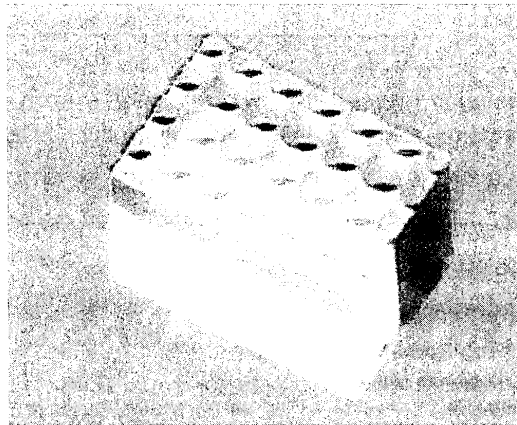
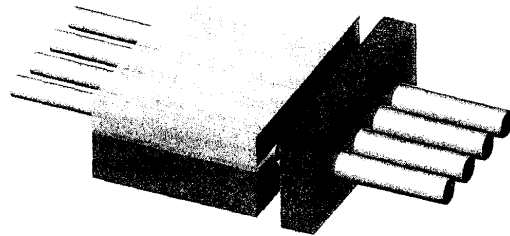

## **Applications**

Collimated optical fiber arrays for various multi-channel communications devices, including DWDM MUX, DeMUX and OADM, optical amplifiers, VOAs, optical isolators, as well as waveguide to fiber coupling.





LEISTER Microsystems  
ISO 9001:2000

### **FCA 250 Fiber Collimating Lens Array Preliminary Specifications**

Array pitch	250 $\mu$ m	Tolerance: $\pm$ 0.25 $\mu$ m
Number of lenses per array	FCA 250-4/720: 4 $\times$ 1 FCA 250-8/720: 8 $\times$ 1 FCA 250-16/720: 16 $\times$ 1	Larger arrays available upon request
Lens array dimensions	FCA 250-4/720: 1.5 mm $\times$ 1.0 mm $\times$ 1.0 mm FCA 250-8/720: 2.5 mm $\times$ 1.0 mm $\times$ 1.0 mm (length $\times$ width $\times$ thickness)	Tolerances: L, W $\pm$ 0.05 mm, T $\pm$ 0.05 mm
Lens diameter	240 $\mu$ m	
Lens surface profile	Optimized aspheric design for peak performance	
Surface figure	< 35 nm RMS	
Numerical aperture	N.A. = 0.16	Custom designs available, e.g. for fiber / waveguide coupling
Effective focal length	720 $\mu$ m (FCA 250-x/720)	Tolerances: < $\pm$ 0.45 % within array
Material	Fused Silica (Schott Lithosil® Q1)	
AR coating	Double sided, for $\lambda$ = 1280-1620 nm	R < 0.5 % per surface
Surface roughness	Ra < 2 nm	
Insertion loss	< 1 dB collimator to collimator	

Customized microlens arrays are available upon request, optimized for your specific element dimensions, alignment marks, as well as pitch, focal length and throw distance.

### **Contact Information**

#### **Headquarters**

LEISTER Process Technologies  
Microsystems Division  
Riedstrasse  
CH-6060 Sarnen/Switzerland  
Phone +41 41 662 74 74  
Fax +41 41 660 20 61  
e-mail [microsystems@leister.com](mailto:microsystems@leister.com)  
[www.leister.com](http://www.leister.com)

#### **USA**

LEISTER Technologies, LLC  
1253 Hamilton Parkway  
Itasca, IL 60143/USA  
Phone (630) 760 1000  
Fax (630) 760 1001  
e-mail [sales@leisterusa.com](mailto:sales@leisterusa.com)  
[www.leisterusa.com](http://www.leisterusa.com)

LEISTER Microsystems Exclusive Distributor



# SOREM

[www.sorem-france.com](http://www.sorem-france.com)

50 années d'expérience à votre service

Une garantie de qualité et d'efficacité

La solution optique sur mesure

## SOREM

2, route de Nay  
4 110 UZOS

tél. : (33) 05 59 06 00 58

fax : (33) 05 59 06 82 84

E-mail : [contact@sorem-france.com](mailto:contact@sorem-france.com)

Site : [www.sorem-france.com](http://www.sorem-france.com)

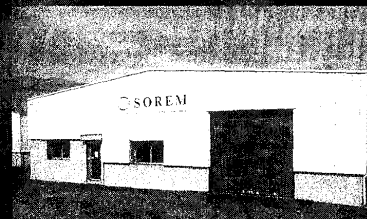

SOREM

PAU - uzos

## Produits :

### • Matériaux :

- ▶ CaF<sub>2</sub>, BaF<sub>2</sub>, LiF, MgF<sub>2</sub>, Ge, Si, SiO<sub>2</sub>, ZnS, ZnSe, KrS<sub>5</sub>, SiC, verres...
- ▶ Une large plage de diamètres - différents standards de qualité en fonction des applications.

### • Composants optiques :

- ▶ Lentilles sphériques, cylindriques, ménisques.
- ▶ Lames/disques : séparateurs, atténuateurs, lames dichroïques avec revêtements en or, argent aluminium...
- ▶ Les pièces peuvent être livrées avec ou sans traitement de surface - gammes de polissage adaptées aux spécifications d'emploi.

### • Ensembles optomécaniques :

- ▶ Hublots d'interface pour visées IR et UV - pour application sous vide ou en environnement sévère - fenêtres et viseurs spéciaux.

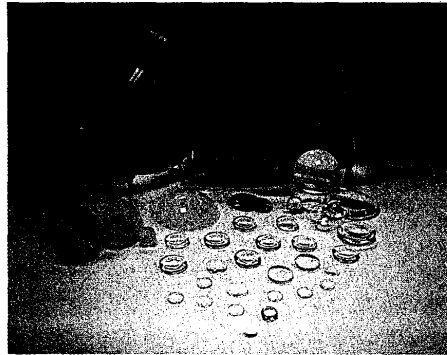

Lentilles

## Services :

### • Etudes et conseils :

- ▶ Choix des solutions - étude et développement en partenariat pour tout composant ou dispositif optique (données matériaux, calculs optiques...).

### • Fabrication / Fournitures :

- ▶ Réalisation d'ensembles ou de composants prototypes, de petite ou de moyenne série.
- ▶ Livraison d'optiques standards sur stock.
- ▶ Maintenance et reconditionnement de composants optiques.

### • Essais / Contrôles :

- ▶ Certificats de contrôle optiques (Interféromètre Laser, Goniomètre, etc...) et métrologiques.
- ▶ Essais de qualification éventuels.

Prismes

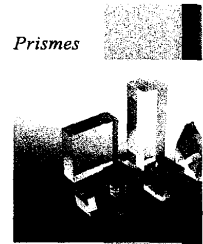

Fenêtres

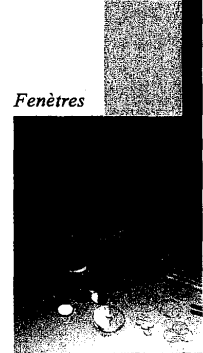

Systèmes  
optomécaniques

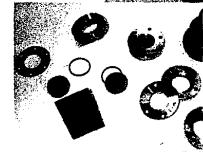

Etude



Mesure  
interférométrique





# SOREM

[www.sorem-france.com](http://www.sorem-france.com)

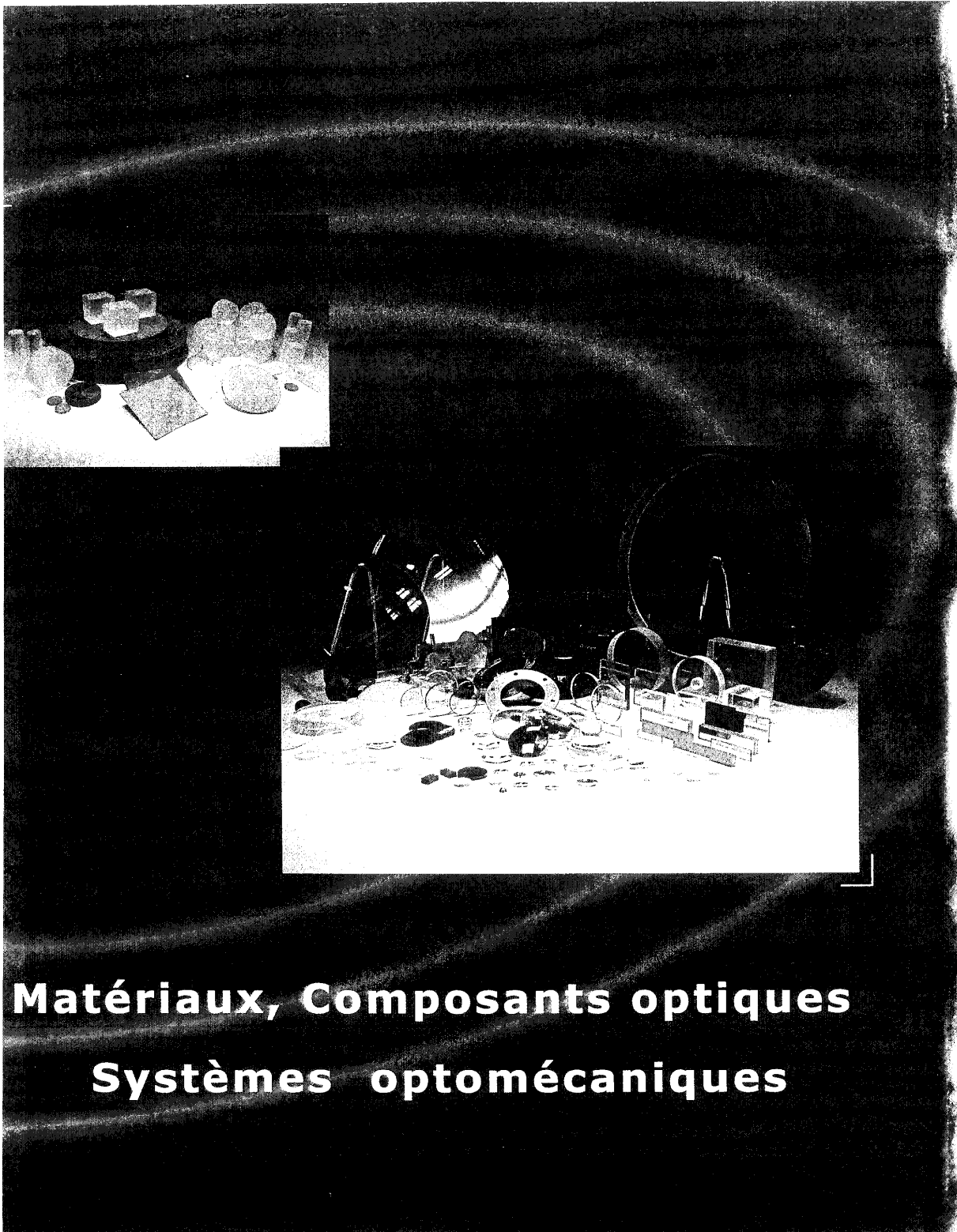

**Matériaux, Composants optiques**  
**Systemes optomécaniques**



issement  
CaF<sub>2</sub>

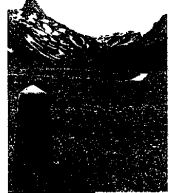

ristaux  
bruts

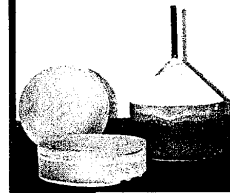

ouchage



lissage



semblage



La SOREM, créée en 1953 avec l'appui du CNRS a développé trois domaines principaux de compétences :

- ▶ La croissance cristalline des matériaux à large bande passante et haute qualité optique (Brevets SOREM)
- ▶ La connaissance et la mise en oeuvre d'un large éventail de matériaux optiques (cristaux, céramiques, verres...) conduisant à la réalisation de composants répondant aux exigences géométriques et de qualité de surface les plus sévères.
- ▶ L'étude et la réalisation d'ensembles optomécaniques associant des fenêtres (planes ou courbes) dans des structures métalliques.



Four de croissance cristalline

La SOREM a une organisation Qualité conforme à l'ISO 9002

Secteurs d'application pivilégiés :

- L'infrarouge :
  - ▶ Industrie civile : contrôle industriel / contrôle pollution / mesure de température / analyse...
  - ▶ Industrie Aérospatiale / Armement / Recherche
- L'ultraviolet :
  - ▶ Laser UV, Espace, Observatoires, Instituts de Recherche...



LEISTER Microsystems  
ISO 9001:2000

# SAC

## Slow Axis Collimator Lens Array

*Array of cylindrical microlenses for collimating the «slow axis» of diode laser beams. The optimal solution for high brightness diode laser sources.*

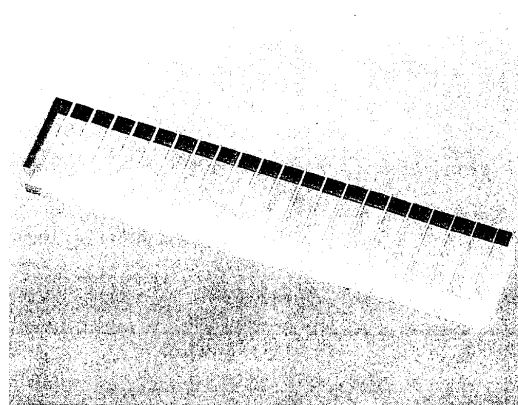

### Benefits

- Compensation of beam astigmatism
- High power resistant  
Fused Silica material
- High surface quality and  
very low surface roughness  
minimize loss
- Compatible with typical  
high power diode laser bars
- Compatible with standard  
fast axis collimators
- Stackable

### Applications

Enhances fiber coupled laser diodes, diode sources for solid-state laser pumping, diode laser direct welding systems, and other high power diode lasers.

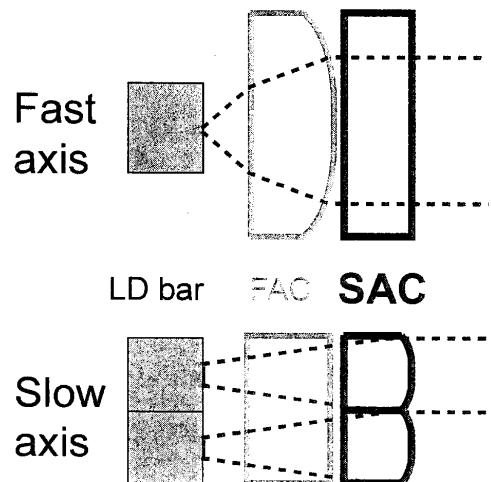



LEISTER Microsystems  
ISO 9001:2000

### SAC 500 Specifications

SAC type	SAC 500/1.5/x	SAC 500/1.1/x	
Array pitch (emitter spacing)	500 $\mu\text{m}$	500 $\mu\text{m}$	Other pitches available upon request
Number of lenses per array	23 $\times$ 1	21 $\times$ 1	
Lens array substrate size	12.0 mm $\times$ 1.5 mm $\times$ 0.6 mm (length $\times$ width $\times$ thickness)	11.0 mm $\times$ 1.1 mm $\times$ 0.6 mm (length $\times$ width $\times$ thickness)	Tolerances: L,W $\pm$ 0.05 mm, T $\pm$ 0.05 mm
Lens surface profile	Cylindrical	Cylindrical	
Effective focal length	1.8 mm (SAC 500/1.5/1.8) 2.0 mm (SAC 500/1.5/2.0) Other values available upon request	1.8 mm (SAC 500/1.1/1.8) 2.0 mm (SAC 500/1.1/2.0) Other values available upon request	Tolerances: < $\pm$ 0.45 % within array < $\pm$ 5 % array to array
Material	Fused Silica (Schott Lithosil® Q1)	Fused Silica (Schott Lithosil®Q1)	
AR coating	Double sided, for $\lambda =$ 770-1080 nm	Double sided, for $\lambda =$ 770-1080 nm	R < 0.5 % per surface
Surface roughness	Ra < 2 nm	Ra < 2 nm	

### Typical surface profile

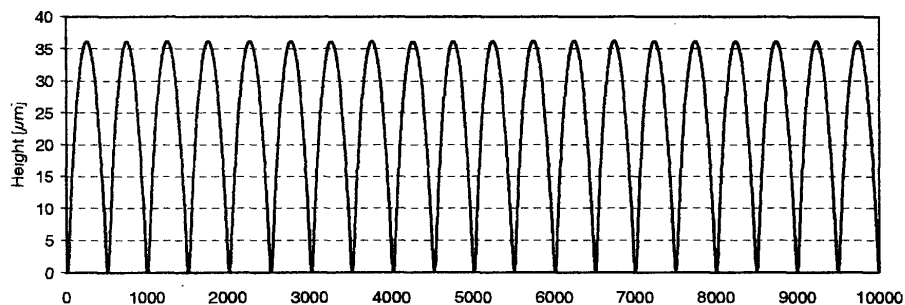

### Contact Information

#### Headquarters

LEISTER Process Technologies  
Microsystems Division  
Riedstrasse  
CH-6060 Sarnen/Switzerland  
Phone +41 41 662 74 74  
Fax +41 41 660 20 61  
e-mail [microsystems@leister.com](mailto:microsystems@leister.com)  
[www.leister.com](http://www.leister.com)

#### USA

LEISTER Technologies, LLC  
1253 Hamilton Parkway  
Itasca, IL 60143/USA  
Phone (630) 760 1000  
Fax (630) 760 1001  
e-mail [sales@leisterusa.com](mailto:sales@leisterusa.com)  
[www.leisterusa.com](http://www.leisterusa.com)

LEISTER Microsystems Exclusive Distributor